

VX Projekt

M484-1

1



SE OBS! Steg 1 och 2 gäller endast vid delad sarg. Vid hela längder gå till steg. 3.

Lägg ut sargarna på golvet.
Förskjut skarvarna så att de ej hamnar parallellt.

EN Note! Step one and two only apply to the split frame. For single frame go to step three.
Place the frame on the floor.
Place joints so that they are not in parallel with each other

2

A T-skrivsmutter /T-nut **B** MF6S M6x12

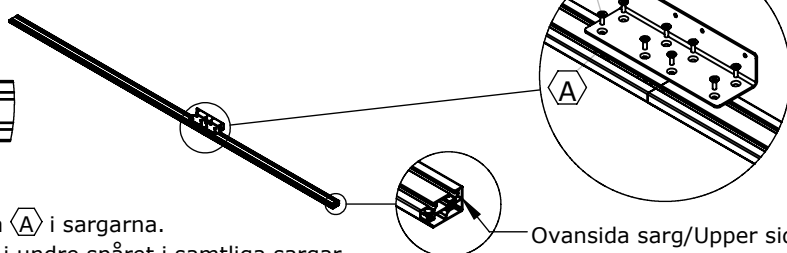

SE **Montera ihop sargarna**

Skjut in T-skrivsmuttrarna **A** i sargarna.
2 st. i övre spåret och 2 st. i undre spåret i samtliga sargar.
Skjut in muttrarna till skarven mellan sargarna och skruva fast vinkelbeslaget med skruv **B**, den bockade delen ska linjera med ovansidan av sargen.

EN Insert the T-nuts **A** in to the frame.
2 pc. on the upper rail and 2 pc. on the lower rail on all frames.
Slide the screw nut all the way to the joint and attach the bracket using screw **B**, the bent part should be in line with the upper side of the frame.

3

A T-skrivsmutter /T-nut





Ovansida/Upper side
Övre spår/Upper rail
Undre spår/Lower rail
Undersida/Lower side

SE Skjut i en T-skrivsmutter **A** i sargens undre spår.

EN Insert a T- nut **A** in to the lower rail of the frame.

VX Projekt

M484-1

4  



Length(table)	Length(frame)	X
3000	2400	340
3200	2600	340
3400	2800	340
3500	2900	390
3600	3000	390
3800	3200	390
4000	3400	440
4200	3600	440
4400	3800	440
4500	3900	540
4600	4000	540
4800	4200	540

SE

Montera vinkelfästet

Placera ut vinkelfästet  på sargen, se mått enligt tabell.
Justera in T-skrusmuttern (från steg 3.) och skruva fast fästet med skruven.

EN

Installing the bracket.

Place bracket  on to the frame, see measurements on table.
Adjust the T-nut (From step 3) and attach bracket with the screw.



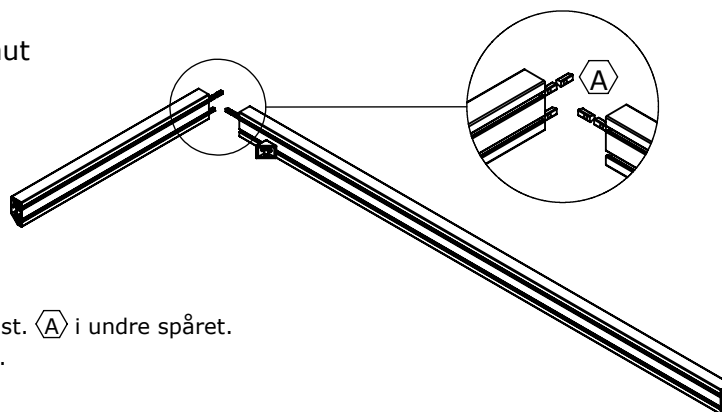

5

  T-skrusmutter /T-nut







SE

Montera gavelsarg

Skjut i T-skrusmuttrar .
Gavelsarg: 2 st.  i övre spåret, 1 st.  i undre spåret.
Långsidesarg: 2 st.  i övre spåret.

EN

Installing end frame.

Insert a T- nut .
Endframe: Upper rail: 2 pc.  Lower rail: 1 pc. .
Long-side frame: Upper rail 2 pc. .

6

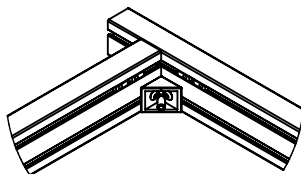

SE

Justera in T-skrusmuttern  och skruva fast gavelsargen i vinkelfästet.

EN

Adjust the T- nut  and attach the end frame to the bracket.

VX Projekt

M484-1

7

T P6S M6x15

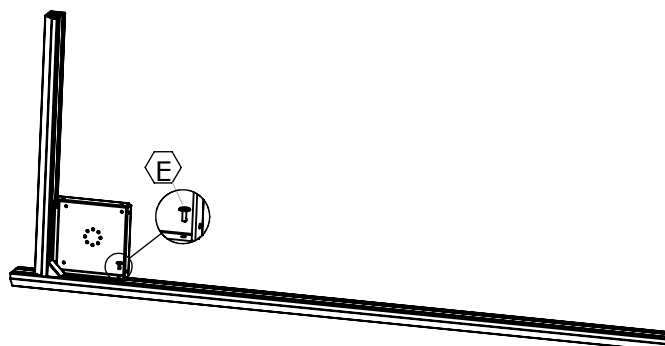

SE Placera metalllådan i hörnet mellan sargarna och justera in T-skruvsmuttrarna centrerade under hålen i lådan. Skruva fast med skruv .

EN Place metal plate in the corner of the frames and place T-nuts centered below the holes of the plate. Attach with screw .

8

F6S M6x8 F6S M6x25

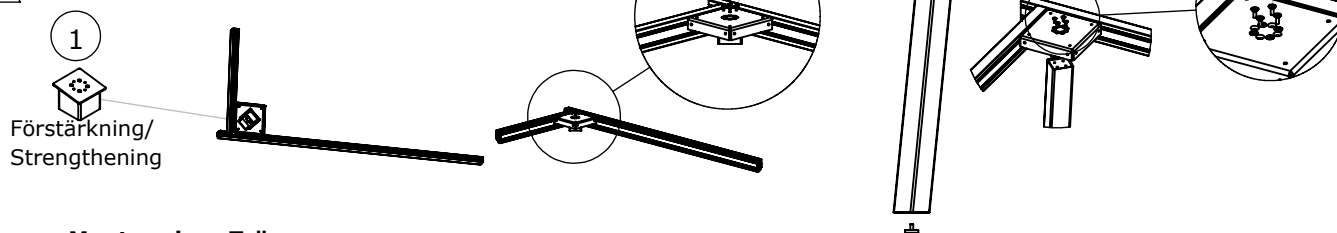

SE Montera ben-Trä
1. Skruva fast förstärkningen i lådan med skruv .
Den ska vara vinklad 45 grader utåt.

2. Skruva i ställfoten i benet.

3. Sätt i träbenet i förstärkningen och skruva fast detta med skruv .

Montera ben-Metall

Skruva fast ställfoten i benet och montera fast benet i lådan med skruv . Benet ska vara vinklad 45 grader utåt.

EN Assemble legs - Wood

1. Attach the reinforcement plate to the corner plate with screw . It should be angled 45 degrees outward.

2. Attach adjustable foot to the wooden leg.

3. Place leg in reinforcement plate and attach with screw .

Assemble leg - Metal

Attach adjustable foot to the leg and attach leg with corner plate with screw .

The leg should be angled 45 degrees outward.

9

H

SE Upprepa steg 3-8 tills du har ett komplett stativ. Sätt dit ändavsluten .

EN Repeat steps 3 through 8 until you have a complete stand. Attach ends .

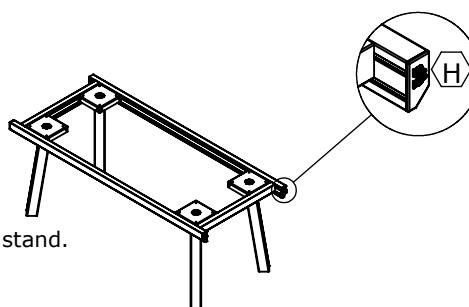

VX Projekt

M484-1

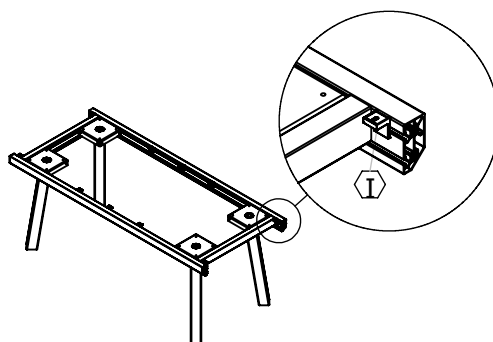
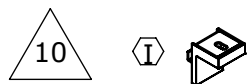

SE Häng på panelfästena i det övre spåret i sargen.
4 st. ska sitta utanför gavelsargarna, se detaljvy.
Resten av fästena fördelas jämnt på de två långsidesargarna.

EN Hang the panel mountings on the upper rail.
4 panel mountings needs to be outside the end frames, see detailed view.
Rest of the mountings need to be distributed evenly on the side frames.

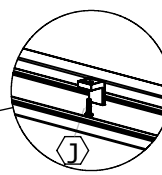
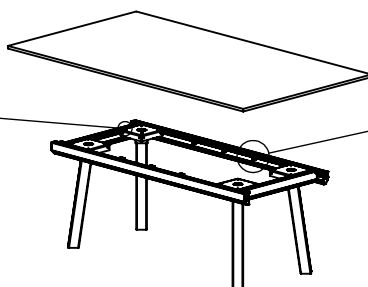
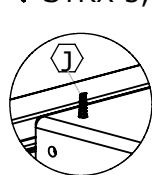

Delad sarg/ split frame

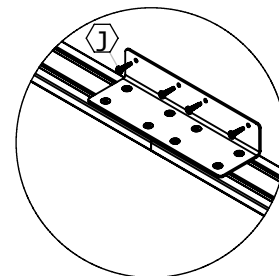

SE **Montera bordsskiva**
Lägg på bordsskivan och skruva fast med skruv . Skivan ska skruvas fast genom panelfästena, metalllådorna och om det är en två-delad sarg även genom vinkelbeslaget.
Om det ä en flerdelad bordsskiva som ska monteras , se instruktion för skivan i steg 12.

EN Place tabletop on the stand and attach with screw . Tabletop should be attached to the panel mountings and corner plates. If it's split frame it should also be attached to the brackets.
If it's a two-split tabletop, see instructions on step 12.

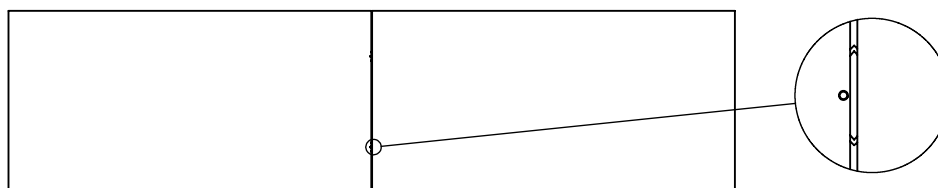

SE För ihop bordsskivorna och lås kopplingsbeslgen genom hålet på bordsskivans undersida

EN Slide the two tabletops together and lock them with the coupling fittings via the holes on the bottom.