



02 FH12 v2

FERREREDS[®]

1936

PRICE LIST 2024-01-01
EUR excl. VAT

HORREDS PRICE LIST EXCL. VAT 2024-01-01

PRICE LIST 1: Office Furniture	
Fast delivery products	3-4
<u>A-FRAME</u>	
Desks	5-7
Screens and accessories	8
<u>NOMONO</u>	
Example arrangements	9-14
Nomono with gables	15-23
Nomono with T-legs	24-26
Accessories Nomono T	27-28
Nomono Duo	29
Accessories Nomon Duo	30
<u>SIGLO</u>	
Desks	31-34
Screens	35
<u>OTHER DESKS:</u>	
VX/Henry/Fri	36-40
Cable entries	41-42
VX8 / VX11 stands	43-44
<u>SCREENS:</u>	
VX desk screen	45-46
A-Frame desk screen	8
<u>OFFICE STORAGE:</u>	
Storage with sliding doors, depth 43cm.	
Basic units	47-49
Extension units	50
Bases	51-52
Sliding doors Biblio	53-55
Sliding doors Nomono	56-58
Sliding doors VX	59-61
Siglo	62-65
Storage with hinged doors, depth 43cm	66-67
Accessories storage	68
<u>PERSONAL STORAGE:</u>	
Personal storage	
Biblio personal storage	69-71
Siglo personal storage	72-74
Tetris personal storage	75-77
VX personal storage	78-80
Accessories personal storage	81-83
Cover panels personal storage	84
Side storage	
Biblio	85-86
Nomono A-side	87-88
Siglo	89-91
VX	92-93
Accessories side storage	94
Drawer pedestals	95

PRICE LIST 2: Meeting/Seating	
<u>MEETING TABLES:</u>	
VX Conference / VX Project / A-Frame	96-110
Nomono conference	111
Tin	112-113
Cable entries and accessories	114-117
<u>SITTMÖBLER / MILJÖMÖBLER:</u>	
Grand chair	118-121
Grand Balk chair	122-123
Glove chair	124-127
Glove Bolster Cover	128
Glove Lounge	129
Glove Bar stool	130
Cuba chair	131-132
Cuba Quilted chair	133-134
Base chair	135-140
VX Bar stool	141
VX Bar stool with castors	142
Log armchair and module sofa	143-146
Mute Focus	147-149
Mute Focus easy chair	150
Mute Floor	151-152
Mute sofa and easy chair	153
Exo Trolley	154
<u>SHELF SYSTEM:</u>	
Anne	155-158
<u>COFFEE TABLES</u>	
Lap	159

<u>INFORMATION:</u>	
Sales terms	160
Pcon Planner	161
Desk profiles	162
Materials and colours	163-165
Price groups fabrics	165-168

Our digital price list is updated continuously.

Products may be added or expire and
price adjustments may occur.

For the latest edition, see www.horreds.se

Edition 24-01-01



Fast delivery products

COMPLETE WORK PLACE IN 10 DAYS

Good logistics solutions are the savior of some projects



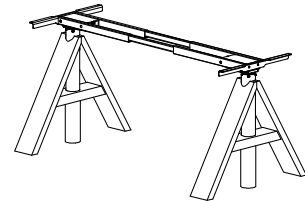
The products will be shipped from us within 10 business days.

We choose not to put any max volumes on this range but must reserve us for out-of-stock.

A-Frame desk tops are available in white HPL (19 mm MDF) and black linoleum (19 mm MDF) without cable lid.

A-Frame electric stand:

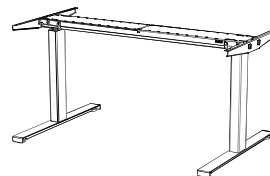
- Range 65 cm (table height 61-126 cm)
- Wooden A-legs in oak or ash with electric legs in white (RAL9016) or black (RAL9005)
- Flexible frame (black RAL9005)
- Lift capacity 160 kg, including table top, in widened weight.
- Power consumption in standby mode: 0,1 W
- PVC-free system
- PVC-fritt system



VX table tops are available in white alt. grey direct laminate (19 mm particle board), white high pressure laminate (19 mm MDF) and black linoleum (19 mm MDF). Comes with 2 cable entries including plastic cover in white or black.

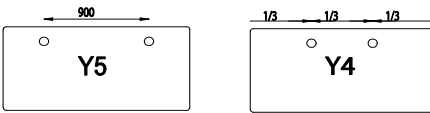
VX11 electric stand:

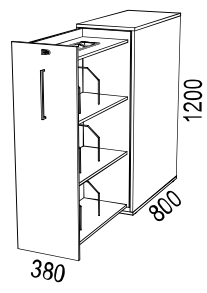
- Range 65 cm (table height 61-126 cm)
- Colours: white (RAL9016) / black (RAL9005)
- Flexible frame 1156-1756 mm (svart RAL9005)
- Lift capacity 160 kg, including table top, in widened weight.
- Power consumption in standby mode: 0,1 W
- PVC-free system
- With built-in anti-collision funtion (DS1)



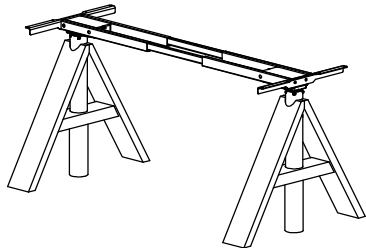
For additional product information: please see www.horreds.se

Desk tops A-Frame	Article nr	White HPL (31)	Black linoleum (88)
A-Frame table top 1600x800 mm	64xx1607550V	477	652
A-Frame table top 1400x800 mm	64xx1607742V	477	652
Electric stand A-frame	Article nr	White (31)	Black (37)
Electr. legs, range 50 (70-120 cm) with wooden A-legs in oak	64xx31250-2	1 654	1 654

Desk tops VX	Article no	White direct laminate (31S)	Light grey dir.lam. (61S)	Vit HPL laminate (31)	Black linoleum (88)
VX table top 1600x800 mm with 2 st cable holes plac Y5	34xx481-07061	194	261		
VX table top 1400x800 mm with 2 st cable holes plac Y5	34xx481-07297	194	261		
VX table top 1200x800 mm with 2 st cable holes plac Y4	34xx481-07298	182	234		
VX table top 1600x800 mm with 2 st cable holes plac Y5	34xx167025K			446	609
VX table top 1400x800 mm with 2 st cable holes plac Y5	34xx167024K			446	609
VX table top 1200x800 mm with 2 st cable holes plac Y4	34xx167023K			446	609
					
Electric stand VX11	Article nr	White (31)	Black (37)		
VX 11 range 65 cm	VX11xx657-1	605	605		
Accessories	Article no	White (31)	Black (37)		
Cable tray 1100 mm (for table tops 1600 och 1400 mm)	29xx140	102	102		
Cable tray 800 mm (for table tops 1200 mm)	29xx142	102	102		

Side storage	Article nr	White
<p>Choose colour of handle: white, black or stainless steel look</p>  <p>VX side storage 380x1200x800 mm. White dir.laminate, incl pen holder and brackets. Left or right. (Illustration shows left)</p>	343121B	1 077

A-Frame Design: Anderssen & Voll**A-FRAME**

- A-Frame desk tops are made of 19 mm MDF with straight edge.
 - Radius 0.
 - Shape rectangular
 - Cable lid in same material as table top as option. Placed on left side as standard.
- | | | |
|--|--|--|
| <ul style="list-style-type: none"> • High Pressure laminate: | <ul style="list-style-type: none"> Closest NCS: | <ul style="list-style-type: none"> • Veneer group 1: |
| White HPL (lam 0754) | S0502-Y | Oak nature (03) |
| Light grey HPL (optional lam 0419) | S2002-Y | Ash nature (06) |
| Light grey HPL (optional lam 1365) | S2005-R80B | • Veneer group 2: |
| Medium grey HPL (opt. lam. 1023) | S5500-N | White pigmented oak (30) |
| Anthracite HPL (opt. lam. 1397) | S7500-N | White pigmented ash (10) |
| Black HPL (optional lam 2253) | S9000-N | Black stained ash (86) |
| | | Dark stained ash (76) |
| | | Burgundy stained ash (C8) |
| | | Conifer stained ash (D3) |
| | | Smokey Blue stained ash (D4) |
- **Linoleum from Forbo Flooring:**
- | | |
|------------------|-----------|
| 4132 Ash | 5502-G |
| 4154 Burgundy | 7010-R10B |
| 4166 Charcoal | 8502-B |
| 4172 Mauve | 7005-Y80R |
| 4174 Conifer | 8010-B90G |
| 4175 Pebble | 3502-Y |
| 4176 Mushroom | 2002-Y |
| 4177 Vapour | 2005-G10Y |
| 4179 Smokey Blue | 7010-R90B |
| 4184 Olive | 5010-G50Y |
- 
- Electric stand, range 50 cm (desk height 70-120 cm).
Electric legs in white (RAL 9016) or black (RAL 9005), with solid wooden A-legs in oak or ash.
 - Fixed stand, desk height 73 cm. Metal leg in white or black with solid wooden A-legs in oak or ash.
 - Brackets information is referring to the desk height (incl the table top)
 - Horreds height adjustment control (touchpad) milled in desk top as option.
 - For additional product information please see www.horreds.se

A-Frame Design: Anderssen & Voll

B

Desks within size 2000x900 mm

Note: Separate prices top tops and stands.

Select first the table top, then add price for stand and options.

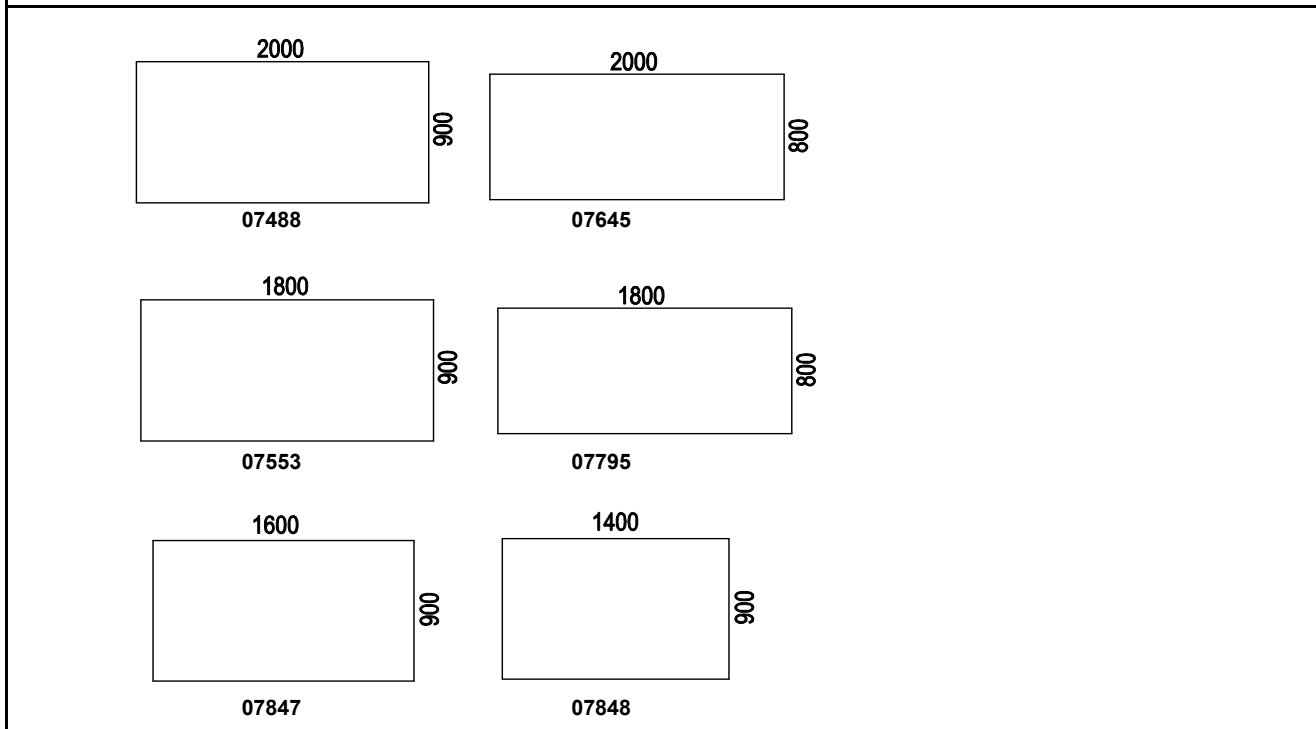
The table's drawing number is listed under the table symbol.

Desk top	Article no	White HPL (31)	Optional HPL (39)	Linoleum (88)	Veneer group 1	Veneer Group 2
A-Frame desk top in B-format	64xx16xxxxB	516	633	752	522	619

Stands	Article no	Solid wood A-legs with white legs	Solid wood A-legs with black legs
Electric stand range 50 cm (70-120) with solid A-legs in oak or ash (nature/stained/white pigmented)	64xx31250-x 64xx37250-x	1 654	1 654
Fixed stand (desk height 73 cm) with solid A-legs in oak or ash (nature/stained/white pigmented)	64xx31200-x 64xx37200-x	985	985

Options:		Upcharge:
Cable lid	64xx07438	152
Horreds touch pad	343707444	55
Veneered edge on laminate table		104
Veneered edge on linoleum table*		104

* only oak/ash nature + white pigmented (not stained).



A-Frame Design: Anderssen & Voll

E Desks within size 1600x800 mm

Note: Separate prices top tops and stands.

Select first the table top, then add price for stand and options.
The table's drawing number is listed under the table symbol.

Desk top	Article no	White HPL (31)	Optional HPL (39)	Linoleum (88)	Veneer group 1	Veneer Group 2
A-Frame desk top in E-format	64xx16xxxxE	477	534	652	497	594

Stands	Article no	Solid wood A-legs with white legs	Solid wood A-legs with black legs
Electric stand range 50 cm (70-120) with solid A-legs in oak or ash (nature/stained/white pigmented)	64xx31250-x 64xx37250-x	1 654	1 654
Fixed stand (desk height 73 cm) with solid A-legs in oak or ash (nature/stained/white pigmented)	64xx31200-x 64xx37200-x	985	985

Options:		Upcharge:
Cable lid	64xx07438	152
Horreds touch pad	343707444	55
Veneered edge on laminate table		104
Veneered edge on linoleum table*		104

* only oak/ash nature + white pigmented (not stained).

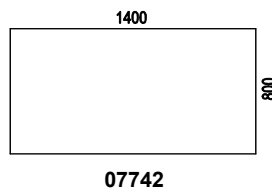
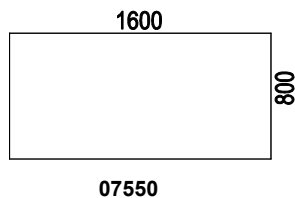

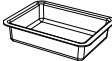





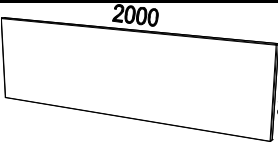
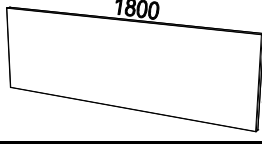
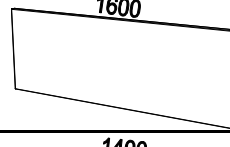
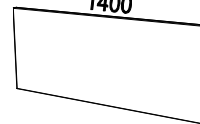


Illustration	Description	Article number	Material	EUR	
A-Frame Design: Anderssen & Voll					
A-Frame ACCESSORIES		RAL colours: 31 White RAL 9016 str 37 Black RAL 9005 str			
	Cable entry including lid 250x150 mm in same material as the desk top. Note: no matching of veneer.	64 31 07438 64 xx 07438 64 xx 07438 64 xx 07438 64 xx 07438	White HPL Optional HPL Linoleum Oak / ash Stained/pigm.	152 152 152 152 152	
	Cable tray in felt 300x220x80 mm	64 98 07403-1	Anthracite	75	
	Shelf in wood , ø 250 mm, höjd 150 mm	64 xx 08990 64 xx 08990	Hard vax oiled oak Veneer gr 2	266 266	
	Shelf in wood, ø 250 mm, incl metal bracket in black or white	64 xxxx 08992 64 xxxx 08992	Hard vax oiled oak Veneer gr 2	257 257	
	Shelf in metal, ø 250 mm, höjd 135 mm	64 31 07430 64 37 07430	White Black	266 266	
	Shelf in metall, ø 250 mm, incl.bracket	64 31 07429 64 xx65 07429	White Black	257 257	
	3-way power outlet, with bracket	34 37 07434	Black	97	
A-frame SOUND ABSORBING DESK SCREEN <ul style="list-style-type: none"> • For mounting in desk top • Thickness approx. 35 mm, of which 30 mm sound absorber • Height over desk: 500 mm • Brackets to be ordered separately • For fabric codes: please see the supplier's website 					
Price group 1: Camira: Cara, Carlow Gabriel: Event Screen, Hush		Price group 2: Camira: Blazer Lite Gabriel: Soul, Soul Mel., Twist, Twist Mel. Kvadrat: Hint Nevotex: Slope		Price group 3: Camira: Blazer, Main Line Flax Gabriel: Bond, Rondo Kvadrat: Remix, Remix Screen, Floyd Screen Nevotex: Lido, Lido Trend, Wooly Wide	
	Sound absorbing desk screen, excluding brackets, length 2000 mm	64 97 82000-x	PG 1 PG 2 PG 3	541 629 700	
	Brackets	34 37 06794-4	svart	93	
	Sound absorbing desk screen, excluding brackets, length 1800 mm	64 97 81800-x	PG 1 PG 2 PG 3	479 559 623	
	Brackets	34 37 06794-4	svart	93	
	Sound absorbing desk screen, excluding brackets, length 1600 mm	64 97 81600-x	PG 1 PG 2 PG 3	453 525 582	
	Brackets	34 37 06794-4	svart	93	
	Sound absorbing desk screen, excluding brackets, length 1400 mm	64 97 81400-x	PG 1 PG 2 PG 3	409 465 534	
	Brackets	34 37 06794-4	svart	93	

Nomono



NOMONO is specially designed to work in open plan offices. Its clear and firm horizontal tables calms down an environment can sometimes be perceived as a bit chaotic with the desktop screens at different altitudes. The legs have covered sides to further tidy up the office.

In Nomono there are integrated cable boxes that hide the cable clutter that usually occurs in an office. The box is handy for laptop, ipod or phone charger. It can also be equipped with a USB or other technology that connects the office.

Nomono has also another type of leg, a more classic height-adjustable leg, we call it Nomono T. Everything to make it possible to use Nomono in all kinds of environments and offices.

It is important that the workplace may look different. You can choose the accessories you want and color after taste or to suit the corporate image.

Nomono is truly worked out in every detail. A reliable, highly competent and attractive fellow worker.

Design: Fredrik Mattson

5520

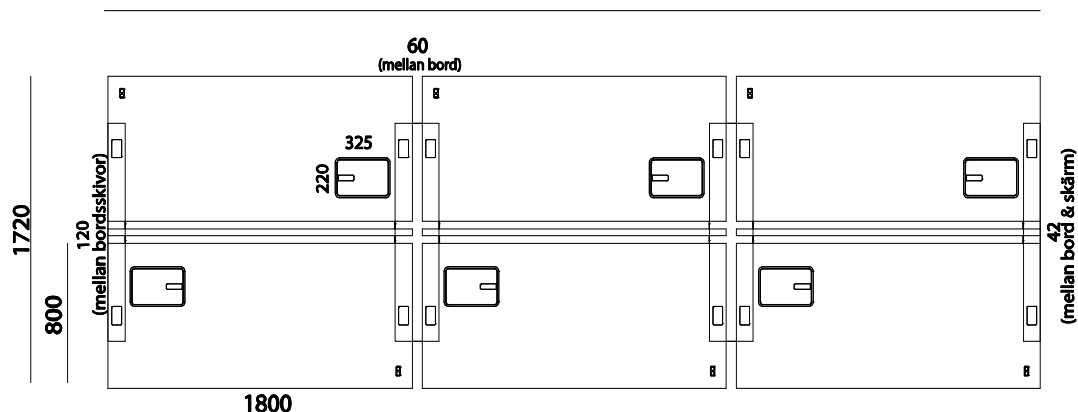


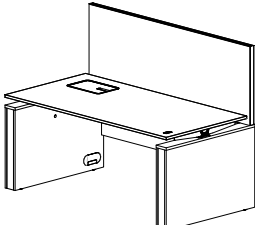
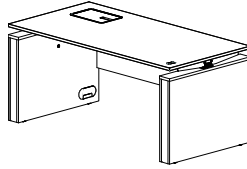
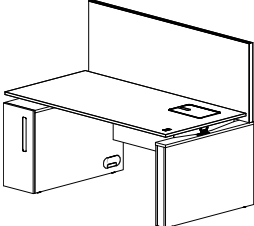
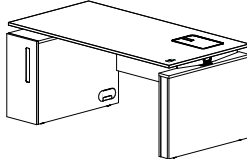
Illustration	Description	Article number	Pcs	Price/ piece	EUR
Nomono Design: Fredrik Mattson					
Nomono ARRANGEMENTS					
<ul style="list-style-type: none"> • We have in the examples below made use of desk tops 1800x800 mm in white laminate. If you choose a different size of desk top, please make sure to adjust to correct size of desk screen, cable etc as well. • The arrangements below do not include accessories. 					
A. <u>Single desk</u>					
	Desk top 1800x800	53 31 5303SEK	1	1002	1 002
	Gable 880x100 mm	53 31 W2500V/H	2	1085	2 170
	Desk screen, fabric in price group 1	34 97 06632-x	1	437	437
	Screen brackets	53 37 01069	1	126	126
	Cable box	53 31 5300xx	1	293	293
	Front panel	53 31 80184	1	264	264
	Cable tray	53 31 03790-2	1	237	237
	Total				
B. <u>Single desk</u>					
	Desk top 1800x800	53 31 5303SEK	1	1002	1 002
	Gable 800x100 mm	53 31 W02445V/H	2	1027	2 054
	Cable box	53 31 5300xx	1	293	293
	Front panel	53 31 80184	1	264	264
	Cable tray	53 31 03790-2	1	237	237
	Total				
C. <u>Single desk with storage</u>					
	Desk top 1800x800	53 31 5322SEK	1	1002	1 002
	Gable 880x100 mm, right	53 31 W02500H	1	1085	1 085
	Gable 880x300 with storage, left	53 31xx W02505V	1	1496	1 496
	Desk screen, fabric in price group 1	34 97 06632-x	1	437	437
	Screen brackets	53 37 01069	1	126	126
	Cable box	53 31 5300xx	1	293	293
	Cable tray	53 31 03790-2	1	237	237
	Total				
D. <u>Single desk with storage</u>					
	Desk top 1800x800	53 31 5322SEK	1	1002	1 002
	Gable 800x100 mm, right	53 31 W02445H	1	1027	1 027
	Gable 800x300 with storage, left	53 31xx W02450V	1	1437	1 437
	Cable box	53 31 5300xx	1	293	293
	Cable tray	53 31 03790-2	1	237	237
	Total				

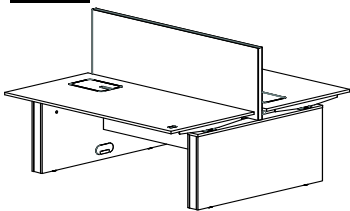
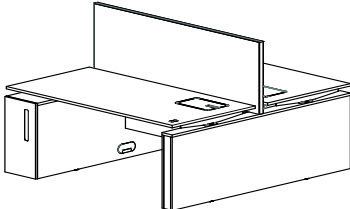
Illustration	Description	Article number	Pcs	Price/ piece	EUR
E. 2-group					
					
	Desk top 1800x800	53 31 5303SEK	2	1002	2 004
	Gable 1200x100 mm	53 31 W02460	2	1525	3 050
	Desk screen, fabric in price group 1	34 97 06632-x	1	437	437
	Screen brackets	53 37 01069	1	126	126
	Cable tray	53 31 03790-4	1	283	283
	Cable box	53 31 5300xx	2	293	586
	Middle panel	53 31 02490-3	1	169	169
	Total				6 655
F. 2-group with storage					
					
	Desktop 1800x800	53 31 5303SEK	1	1002	1 002
	Desktop 1800x800	53 31 5322SEK	1	1002	1 002
	Gable 1720x100 mm	53 31 W02470	1	1555	1 555
	Gable 1720x300 mm with storage	53 31xx W02485	1	2230	2 230
	Desk screen, fabric in price group 1	34 97 06632-x	1	437	437
	Screen brackets	53 37 01069	1	126	126
	Cable tray	53 31 03790-4	1	283	283
	Cable box	53 31 5300xx	2	293	586
	Total				7 221

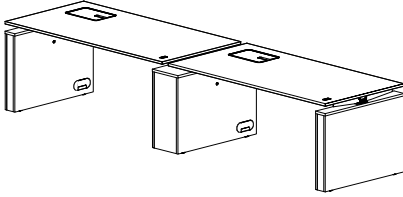
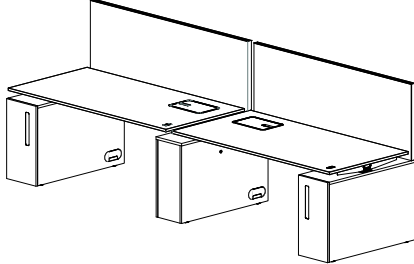
Illustration	Description	Article number	Pcs	Price/ piece	EUR
G1. <u>2-group side by side</u>					
					
	Desk top 1800x800	53 31 5303SEK	2	1002	2 004
	Gable 800x100 mm	53 31 W02445V/H	2	1027	2 054
	Gable 800x260 mm	53 31 W02455	1	1525	1 525
	Cable box	53 31 5300xx	2	293	586
	Cable tray	53 31 03790-2	2	237	474
	<u>Total</u>				<u>6 643</u>
G2. <u>2-group side by side with storage</u>					
					
	Desk top 1800x800	53 31 5303SEK	1	1002	1 002
	Desk top 1800x800	53 31 5322SEK	1	1002	1 002
	Gable 880x300 with storage	53 31 W02505V/H	2	1496	2 992
	Gable 880x260 mm	53 31 W03075	1	1584	1 584
	Desk screen, fabric in price group 1	34 97 06632-x	2	437	874
	Screen brackets	53 37 01069	2	126	252
	Cable box	53 31 5300xx	2	293	586
	Cable tray	53 31 03790-2	2	237	474
	<u>Total</u>				<u>8 766</u>

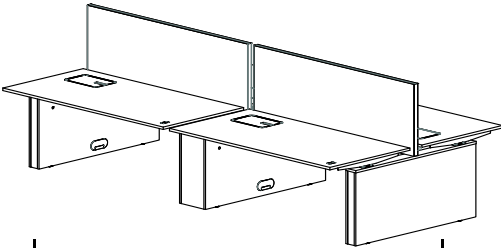
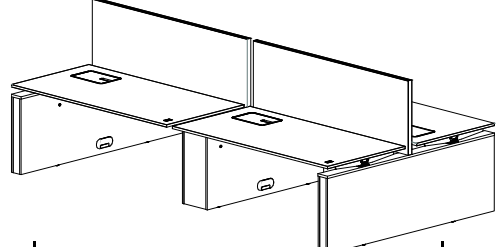
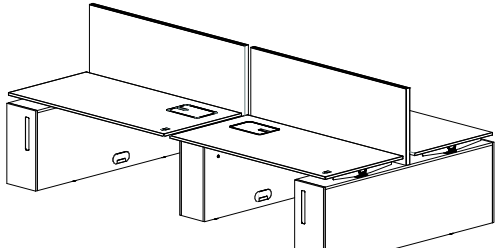
Illustration	Description	Article number	Pcs	Price/ piece	EUR
H. 4-group (with gables 1200 mm)					
					
	Desk top 1800x800	53 31 5303SEK	4	1002	4 008
	Gable 1200x100 mm	53 31 W02460	2	1525	3 050
	Gable 1200x260 mm	53 31 W02465	1	2318	2 318
	Desk screen, fabric in price group 1	34 97 06632-x	2	437	874
	Screen brackets	53 37 01069	2	126	252
	Cable tray	53 31 03790-4	2	283	566
	Cable box	53 31 5300xx	4	293	1 172
	Total				12 240
I. 4-group (with outer gables 1720 mm)					
					
	Desk top 1800x800	53 31 5303SEK	4	1002	4 008
	Gable 1720x100	53 31 W02470	2	1555	3 110
	Gable 1200x260 mm	53 31 W02465	1	2318	2 318
	Desk screen, fabric in price group 1	34 97 06632-x	2	437	874
	Screen brackets	53 37 01069	2	126	252
	Cable tray	53 31 03790-4	2	283	566
	Cable box	53 31 5300xx	4	293	1 172
	Total				12 300
J. 4-grup with storage					
					
	Desk top 1800x800	53 31 5303SEK	2	1002	2 004
	Desk top 1800x800	53 31 5322SEK	2	1002	2 004
	Gable 1720x300 with storage	53 31xx W02485	2	2230	4 460
	Gable 1200x260	53 31 W02465	1	2318	2 318
	Desk screen, fabric in price group 1	34 97 06632-x	2	437	874
	Screen brackets	53 37 01069	2	126	252
	Cable tray	53 31 03790-4	2	283	566
	Cable box	53 31 5300xx	4	293	1 172
	Total				13 650

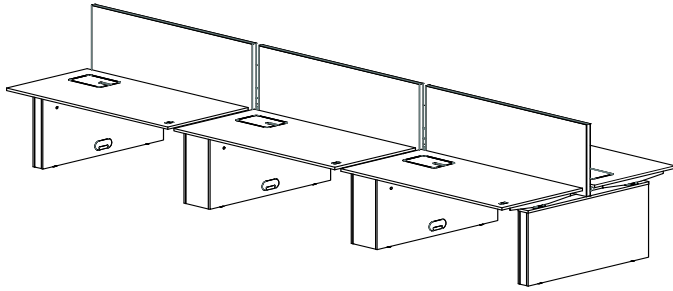
Illustration	Description	Article number	Pcs	Price/ piece	EUR
K. 6-group					
					
	Desk top 1800x800	53 31 5303SEK	6	1002	6 012
	Gable 1200x100 mm	53 31 W02460	2	1525	3 050
	Gable 1200x260 mm	53 31 W02465	2	2318	4 636
	Desk screen, fabric in price group 1	34 97 06632-x	3	437	1 311
	Screen brackets	53 37 01069	3	126	378
	Cable tray	53 31 03790-4	3	283	849
	Cable box	53 31 5300xx	6	293	1 758
	Total				<u>17 994</u>





Illustration	Description	Article number	Material	EUR		
<p>Nomono Design: Fredrik Mattson</p>  <p>Nomono DESK TOPS</p> <ul style="list-style-type: none"> Nomono desk tops are made of 19 mm MDF. Radius 0. Gables not included in below prices. Order separately. Price for cable lid is not included in below prices. Order separately. For additional product information: please see www.horreds.se <p>MÖBELFAKTA</p> <p><u>White HPL:</u> closest NCS S0502-Y <u>Optional HPL:</u> Light grey, medium grey, anthracite and black. <u>Linoleum:</u> 4132 Ash, 4154 Burgundy, 4166 Charcoal, 4172 Mauve, 4174 Conifer, 4175 Pebble, 4176 Mushroom, 4177 Vapour, 4179 Smokey Blue, 4184 Olive. <u>Veneer group 1:</u> Oak (03) / Ash (06) <u>Veneer group 2:</u> White pigmented Oak (30), White pigmented Ash (10), Black stained Ash (86), Dark stained Ash (76), Burgundy stained ash (C8), Conifer stained ash (D3), Smokey Blue stained ash (D4).</p>						
	Desk top 2000x900 mm. Including touchpad, frame and trafo. Prepared for cable box left side	53 31 5306SEK 53 xx 5306SEK 53 xx 5306SEK 53 xx 5306SEK 53 xx 5306SEK	White HPL Optional HPL Linoleum Veneer group 1 Veneer group 2	1 002 1 116 1 201 1 008 1 102		
	Desk top 2000x900 mm. Including touchpad, frame and trafo. Prepared for cable box right side	53 31 5321SEK 53 xx 5321SEK 53 xx 5321SEK 53 xx 5321SEK 53 xx 5321SEK	White HPL Optional HPL Linoleum Veneer group 1 Veneer group 2	1 002 1 116 1 201 1 008 1 102		
		Desk top 2000x800 mm. Including touchpad, frame and trafo. Prepared for cable box left side	53 31 5305SEK 53 xx 5305SEK 53 xx 5305SEK 53 xx 5305SEK	White HPL Optional HPL Linoleum Veneer group 1 Veneer group 2	1 002 1 116 1 201 1 008 1 102	
		Desk top 2000x800 mm. Including touchpad, frame and trafo. Prepared for cable box right side	53 31 5324SEK 53 xx 5324SEK 53 xx 5324SEK 53 xx 5324SEK 53 xx 5324SEK	White HPL Optional HPL Linoleum Veneer group 1 Veneer group 2	1 002 1 116 1 201 1 008 1 102	
			Desk top 1800x900 mm. Including touchpad, frame and trafo. Prepared for cable box left side	53 31 5304SEK 53 xx 5304SEK 53 xx 5304SEK 53 xx 5304SEK 53 xx 5304SEK	White HPL Optional HPL Linoleum Veneer group 1 Veneer group 2	1 002 1 116 1 201 1 008 1 102
			Desk top 1800x900 mm. Including touchpad, frame and trafo. Prepared for cable box right side	53 31 5318SEK 53 xx 5318SEK 53 xx 5318SEK 53 xx 5318SEK 53 xx 5318SEK	White HPL Optional HPL Linoleum Veneer group 1 Veneer group 2	1 002 1 116 1 201 1 008 1 102





Illustration	Description	Article number	Material	EUR			
	Desk top 1800x800 mm. Including touchpad, frame and trafo. Prepared for cable box left side	53 31 5303SEK 53 xx 5303SEK 53 xx 5303SEK	White HPL Optional HPL Linoleum	1 002 1 116 1 201			
	Desk top 1800x800 mm. Including touchpad, frame and trafo. Prepared for cable box right side	53 31 5322SEK 53 xx 5322SEK 53 xx 5322SEK 53 xx 5322SEK 53 xx 5322SEK	White HPL Optional HPL Linoleum Veneer group 1 Veneer group 2	1 002 1 116 1 201 1 008 1 102			
		Desk top 1600x900 mm. Including touchpad, frame and trafo. Prepared for cable box left side	53 31 5302SEK 53 xx 5302SEK 53 xx 5302SEK	White HPL Optional HPL Linoleum	1 002 1 116 1 201		
		Desk top 1600x900 mm. Including touchpad, frame and trafo. Prepared for cable box right side	53 31 5320SEK 53 xx 5320SEK 53 xx 5320SEK 53 xx 5320SEK 53 xx 5320SEK	White HPL Optional HPL Linoleum Veneer group 1 Veneer group 2	1 002 1 116 1 201 1 008 1 102		
			Desk top 1600x800 mm. Including touchpad, frame and trafo. Prepared for cable box left side	53 31 5301SEK 53 xx 5301SEK 53 xx 5301SEK	White HPL Optional HPL Linoleum	964 1 000 1 131	
			Desk top 1600x800 mm. Including touchpad, frame and trafo. Prepared for cable box right side	53 31 5323SEK 53 xx 5323SEK 53 xx 5323SEK 53 xx 5323SEK 53 xx 5323SEK	White HPL Optional HPL Linoleum Veneer group 1 Veneer group 2	983 1 077 964 1 000 1 131 983 1 077	
				Desk top 1400x900 mm. Including touchpad, frame and trafo. Prepared for cable box left side	53 31 5311SEK 53 xx 5311SEK 53 xx 5311SEK	White HPL Optional HPL Linoleum	964 1 000 1 131
				Desk top 1400x900 mm. Including touchpad, frame and trafo. Prepared for cable box right side	53 31 5339SEK 53 xx 5339SEK 53 xx 5339SEK 53 xx 5339SEK 53 xx 5339SEK	White HPL Optional HPL Linoleum Veneer group 1 Veneer group 2	983 1 077 964 1 000 1 131 983 1 077

Illustration	Description	Article number	Material	EUR	
	Desk top 1400x800 mm. Including touchpad, frame and trafo. Prepared for cable box left side	53 31 5312SEK 53 xx 5312SEK 53 xx 5312SEK 53 xx 5312SEK 53 xx 5312SEK	White HPL Optional HPL Linoleum Veneer group 1 Veneer group 2	964 1 000 1 131 983 1 077	
	Desk top 1400x800 mm. Including touchpad, frame and trafo. Prepared for cable box right side	53 31 5338SEK 53 xx 5338SEK 53 xx 5338SEK 53 xx 5338SEK 53 xx 5338SEK	White HPL Optional HPL Linoleum Veneer group 1 Veneer group 2	964 1 000 1 131 983 1 077	
	Nomono GABLES				
	Color handles / closest NCS:				
	31 White S 0300-N				
	37 Black S 9000-N				
	32 Yellow S 1070-Y				
	36 Green S 2570-G30Y				
	33 Red S 1580-Y80R				
	35 Turquoise S0540-B30G				
42 Orange S 1080-YEOP					
<ul style="list-style-type: none"> • Including electrical legs, adjustable 73-120 cm • Height from floor to top of gable: 618 mm • <u>Veneer group 1</u>: Oak (03) / Ash (06) • <u>Veneer group 2</u>: white oak (30), black ash (86), white ash (10), dark ash (76) Burgundy st. ash(C8) Conifer st.ash (D3), Smokey Blue st.ash (D4). Options: <ul style="list-style-type: none"> • Gable door with lock: additional € 65 / door • Cable hole outer side of gable: additional € 92 / gable • Handles in Elmosoft 54035 Light Brown € 35:- / handle 					
Depth 800 mm - for single desk <u>without</u> desk screen					
	Gable 800x100, left	53 31 W02445V 53 xx x02445V 53 xx x02445V	White dir.laminate Veneer group 1 Veneer group 2	1 027 1 467 1 643	
	Gable 800x100, right	53 31 W02445H 53 xx x02445H 53 xx x02445H	White dir.laminate Veneer group 1 Veneer group 2	1 027 1 467 1 643	
	Gable 800x300 mm, left, with storage	53 31xx W02450V 53 xxxx x02450V 53 xxxx x02450V	White dir.laminate Veneer group 1 Veneer group 2	1 437 2 288 2 523	
	Gable 800x300 mm, right, with storage	53 31xx W02450H 53 xxxx x02450H 53 xxxx x02450H	White dir.laminate Veneer group 1 Veneer group 2	1 437 2 288 2 523	
	Gable 800x400 mm, left, with withdrawable storage	53 31xx W03330V 53 xxxx x03330V 53 xxxx x03330V	White dir.laminate Veneer group 1 Veneer group 2	2 171 2 816 3 022	
	Gable 800x400 mm, right with withdrawable storage	53 31xx W03330H 53 xxxx x03330H 53 xxxx x03330H	White dir.laminate Veneer group 1 Veneer group 2	2 171 2 816 3 022	
	Gable, middle, 800x260 mm	53 31 W02455 53 xx x02455 53 xx x02455	White dir.laminate Veneer group 1 Veneer group 2	1 525 1 995 2 171	

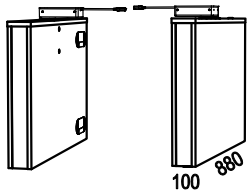
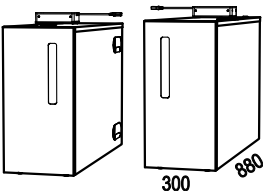
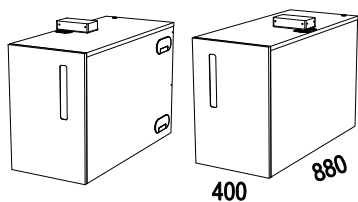
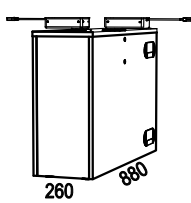
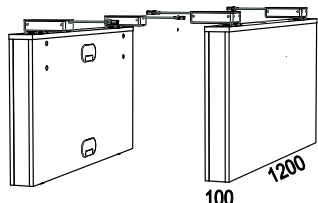
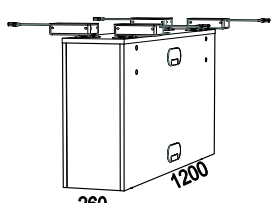
Illustration	Description	Article number	Material	EUR	
Depth 880 mm - for single desk with desk screen					
	Gable 880x100 mm, left	53 31 W02500V 53 xx x02500V 53 xx x02500V	White dir.laminate Veneer group 1 Veneer group 2	1 085 1 584 1 760	
	Gable 880x100 mm, right	53 31 W02500H 53 xx x02500H 53 xx x02500H	White dir.laminate Veneer group 1 Veneer group 2	1 085 1 584 1 760	
		Gable 880x300 mm, left, with storage	53 31xx W02505V 53 xxxx x02505V 53 xxxx x02505V	White dir.laminate Veneer group 1 Veneer group 2	1 496 2 406 2 640
		Gable 880x300 mm, right with storage	53 31xx W02505H 53 xxxx x02505H 53 xxxx x02505H	White dir.laminate Veneer group 1 Veneer group 2	1 496 2 406 2 640
			Gable 880x400 mm, left, with withdrawable storage	53 31xx W03955V 53 xxxx x03955V 53 xxxx x03955V	White dir.laminate Veneer group 1 Veneer group 2
	Gable 880x400 mm, right, with withdrawable storage		53 31xx W03955H 53 xxxx x03955H 53 xxxx x03955H	White dir.laminate Veneer group 1 Veneer group 2	2 230 2 934 3 139
	Gable, middle, 880x260 mm		53 31 W03075 53 xx x03075 53 xx x03075	White dir.laminate Veneer group 1 Veneer group 2	1 584 2 112 2 288
	Depth 1200 mm				
		Gable 1200x100 mm.	53 31 W02460 53 xx x02460 53 xx x02460	White dir.laminate Veneer group 1 Veneer group 2	1 525 2 024 2 200
		Gable, middle, 1200x260 mm.	53 31 W02465 53 xx x02465 53 xx x02465	White dir.laminate Veneer group 1 Veneer group 2	2 318 2 816 2 992

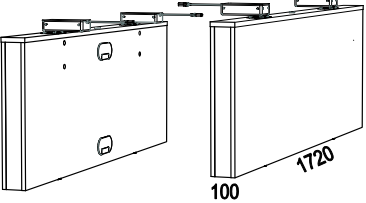
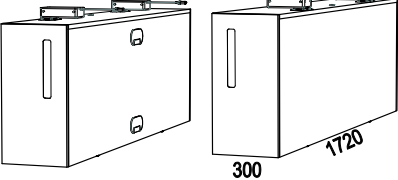
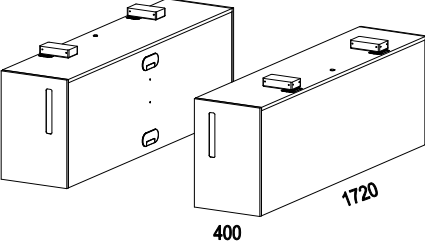
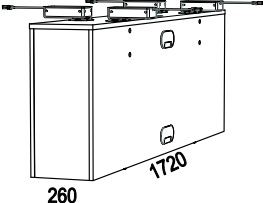
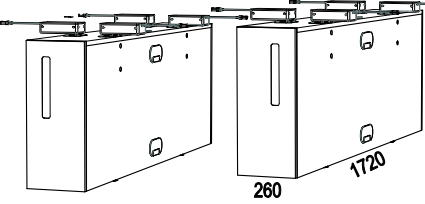
Illustration	Description	Article number	Material	EUR
Depth 1720 mm				
	Gable 1720x100 mm	53 31 W02470 53 xx x02470 53 xx x02470	White dir.laminate Veneer group 1 Veneer group 2	1 555 2 054 2 230
	Gable 1720x300 mm, with storage	53 31xx W02485 53 xxxx x02485 53 xxxx x02485	White dir.laminate Veneer group 1 Veneer group 2	2 230 3 520 3 814
	Gable, 1720x400 mm, with withdrawable storage	53 31xx W04024 53 xxx x04024 53 xxx x04024	White dir.laminate Veneer group 1 Veneer group 2	3 755 4 459 4 723
	Gable, middle, 1720x260 mm	53 31 W02475 53 xx x02475 53 xx x02475	White dir.laminate Veneer group 1 Veneer group 2	2 464 3 051 3 227
	Gable, middle, 1720x260 mm, with storage	53 31xx W02480 53 xxxx x02480 53 xxxx x02480	White dir.laminate Veneer group 1 Veneer group 2	3 081 4 400 4 694


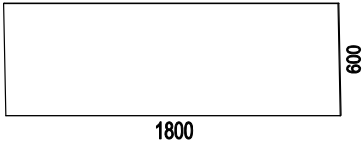
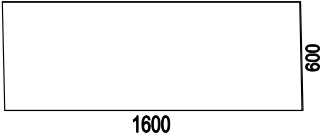
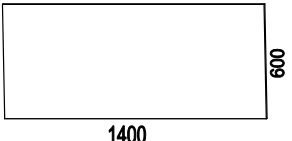
Illustration	Description	Article number	Material	EUR	
<p>Nomono SOUND ABSORBING DESK SCREENS</p> <ul style="list-style-type: none"> • For mounting in gables • Thickness approx.35 mm, of which 30 mm sound absorber • Fixed height from floor: 120 cm. • Brackets to be ordered separately • For fabric codes: please see the supplier's website 					
<p>Price group 1:</p> <p><u>Camira:</u> Cara, Carlow <u>Gabriel:</u> Event Screen, Hush</p>		<p>Price group 2:</p> <p><u>Camira:</u> Blazer Lite <u>Gabriel:</u> Soul, Soul Melange, Twist, Twist Melange <u>Kvadrat:</u> Hint <u>Nevotex:</u> Slope</p>		<p>Price group 3:</p> <p><u>Camira:</u> Blazer, Main Line Flax <u>Gabriel:</u> Bond, Rondo <u>Kvadrat:</u> Remix, Remix Screen, Floyd Screen <u>Nevotex:</u> Lido, Lido Trend, Wooly Wide</p>	
	<p>Sound absorbing desk screen, excluding brackets, length 2000 mm</p> <p>Brackets</p>	<p>34 97 04230-x</p> <p>53 37 01069</p>	<p>PG 1 PG 2 PG 3</p>	<p>524 619 700 126</p>	
	<p>Sound absorbing desk screen, excluding brackets, length 1800 mm</p> <p>Brackets</p>	<p>34 97 06632-x</p> <p>53 37 01069</p>	<p>PG 1 PG 2 PG 3</p>	<p>437 515 583 126</p>	
	<p>Sound absorbing desk screen, excluding brackets, length 1600 mm</p> <p>Brackets</p>	<p>34 97 04207-x</p> <p>53 37 01069</p>	<p>PG 1 PG 2 PG 3</p>	<p>377 431 528 126</p>	
	<p>Sound absorbing desk screen, excluding brackets, length 1400 mm</p> <p>Brackets</p>	<p>34 97 07052-x</p> <p>53 37 01069</p>	<p>PG 1 PG 2 PG 3</p>	<p>367 420 491 126</p>	

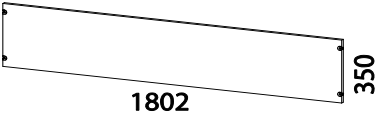

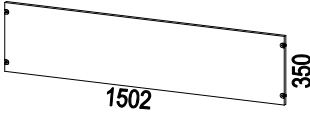


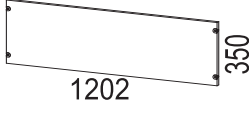
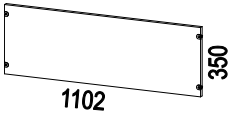
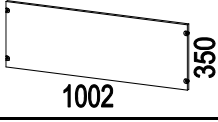
Illustration	Description	Article number	Material	EUR
Nomono FRONT PANELS • Required for single desks with gables without storage in order to obtain sufficient stability. • For single desks with storage the front panels are optional.				
	Front panel 1802x350 mm. For desk: 2000 mm with gables without storage	53 31 80204 53 xx 80204 53 xx 80204	White dir.laminate Veneer group 1 Veneer group 2	264 411 440
	Front panel 1602x350 mm. For desks: 1800 mm with gables without storage 2000 mm with gable storage one side	53 31 80184 53 xx 80184 53 xx 80184	White dir.laminate Veneer group 1 Veneer group 2	264 411 440
	Front panel 1502x350 mm. For desk: 2000 mm with gable with withdrawable storage one side	53 31 80205 53 xx 80205 53 xx 80205	White dir.laminate Veneer group 1 Veneer group 2	264 411 440
	Front panel 1402x350 mm. For desks: 1600 mm with gables without storage 1800 mm with gable w.storage one side	53 31 80164 53 xx 80164 53 xx 80164	White dir.laminate Veneer group 1 Veneer group 2	264 411 440
	Front panel 1302x350 mm. For desk: 1800 mm with gable with withdrawable storage one side	53 31 80185 53 xx 80185 53 xx 80185	White dir.laminate Veneer group 1 Veneer group 2	264 411 440
	Front panel 1202x350 mm. For desks: 1400 mm with gables without storage 1600 mm with gable storage one side	53 31 80144 53 xx 80144 53 xx 80144	White dir.laminate Veneer group 1 Veneer group 2	264 411 440
	Front panel 1102x350 mm. For desk: 1600 mm with gable with withdrawable storage one side	53 31 80165 53 xx 80165 53 xx 80165	White dir.laminate Veneer group 1 Veneer group 2	264 411 440
	Front panel 1002x350 mm. For desk: 1400 mm with gable storage one side	53 31 80124 53 xx 80124 53 xx 80124	White dir.laminate Veneer group 1 Veneer group 2	264 411 440
Nomono MIDDLE PANELS • Required for 2-groups (desks placed opposite each other) with gables without storage in order to obtain sufficient stability.				
	Middle panel 1802x200 mm. For desk 2000 mm with gables without storage	53 31 02490-4 53 xx 02490-4 53 xx 02490-4	White dir.laminate Veneer group 1 Veneer group 2	169 262 291
	Middle panel 1602x200 mm. For desk 1800 mm with gables without storage	53 31 02490-3 53 73 02490-3 53 xx 02490-3	White dir.laminate Veneer group 1 Veneer group 2	169 262 291
	Middle panel 1402x200 mm. For desk 1600 mm with gables without storage	53 31 02490-2 53 73 02490-2 53 xx 02490-2	White dir.laminate Veneer group 1 Veneer group 2	169 262 291
	Middle panel 1202x200 mm. For desk 1400 mm with gables without storage	53 31 02490-1 53 73 02490-1 53 xx 02490-1	White dir.laminate Veneer group 1 Veneer group 2	169 262 291


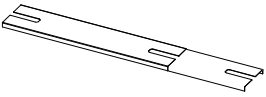






Illustration	Description	Article number	Material	EUR
<p>Nomono CABLE TRAYS • Flexible cable tray for mounting in gables</p>				
	<p>Flexible cable tray to single desks and groups side by side. Incl 2xpower 1 cable tray/desk is required.</p> <p>Flexible cable tray for groups with 2 desks opposite each other. Incl. 4xpower. 1 cable tray/2 desks is required.</p> <p><i>Not suitable to desk length 1400 mm with withdrawable gable.</i></p>	<p>53 31 03790-2 53 37 03790-2</p> <p>53 31 03790-4 53 37 03790-4</p>	<p>White Black</p> <p>White Black</p>	<p>237 237</p> <p>283 283</p>
	<p>Lid for flexible cable tray</p>	<p>53 31 03792 53 37 03792</p>	<p>White Black</p>	<p>90 90</p>

Illustration	Description	Article number	Material	EUR
Nomono ACCESSORIES				
Plastic details: 31 White S 0300-N 37 Black S 9000-N				
	Extra cost for shutter on desk top. Incl. 3-way standard socket and cable pipe in textile. The cable lid is made of the same material as the desk top, with MDF edges.	53 31 5300xx 53 xx 5300xx 53 xx 5300xx 53 xx 5300xx 53 xx 5300xx	White HPL Optional HPL Linoleum Veneer group 1 Veneer group 2	293 293 293 293 293
	Arm with assembled pen drawer for mounting in desk top or on rail. alt. tillbehörsskena	53 31xx 01149 53 37xx 01149	White arm Black arm	137 137
	Single pen drawer	53 31 01149 53 37 01149	White Black	63 63
	Arm with assembled mail drawer for mounting in desk top or on rail.	53 31xx 01148 53 37xx 01148	White arm Black arm	137 137
	Single mail drawer	53 31 01148 53 37 01148	White Black	63 63
	Arm with laptop holder, for mounting in desk top or on rail <i>* outgoing product</i>	53 31 02526 53 37 02526	White * Black *	155 155

Nomono T Design: Fredrik Mattson

NOMONO T DESK TOPS



- Choose desk top from format B or E.
- Complete prices including desk top, frame and electrical T-legs.
- Nomono T desk tops are made of 19 mm MDF with straight edge.
- Height adjustment control (touch pad) always on the right side of the desk.
- Radius 0.
- Shape rectangular
- The cable box is always placed on the left side of the desk top.
- Electrical T-legs for 2 desks, see Nomono Duo



• Desktop from Forbo Flooring:

4132 Ash	5502-G
4154 Burgundy	7010-R10B
4166 Charcoal	8502-B
4172 Mauve	7005-Y80R
4174 Conifer	8010-B90G
4175 Pebble	3502-Y
4176 Mushroom	2002-Y
4177 Vapour	2005-G10Y
4179 Smokey Blue	7010-R90B
4184 Olive	5010-G50Y

• Veneer group 1:

- Oak nature (03)
- Ash nature (06)

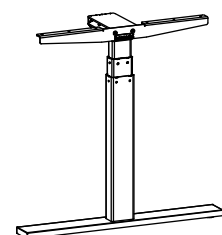
• Veneer group 2:

- White pigmented oak (30)
- Black stained ash (86)
- White pigmented ash (10)
- Dark stained ash (76)
- Burgundy stained ash (C8)
- Conifer stained ash (D3)
- Smokey Blue stained ash (D4)

• High Pressure Laminate:

	Closest NCS:
White HPL (lam0754)	S0502-Y
Light grey HPL (optional lam 0419)	S2002-Y
Light grey HPL (optional lam 1365)	S2005-R80B
Medium grey HPL (opt. Lam 1023)	S5500-N
Anthracite HPL (opt. lam 1397)	S7500-N
Black HPL (optional lam 2253)	S9000-N

- Electrical T-leg with anti-collision-solution
- Massive feet
- Brackets information is referring to the desk height (inkl the top)
- For additional product information: please see www.horreds.se



Nomono T Design: Fredrik Mattson

B

Desks within size 2000x900 mm

Complete package with desk top, frame and electrical T-legs.

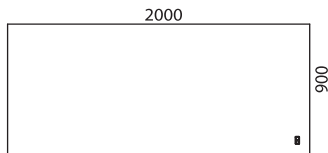
Please replace the first 2 xx in the article number with the material code for the desk top.

Next 4 xxxx should be replaced with the code for the desk (the code under the desk symbol)

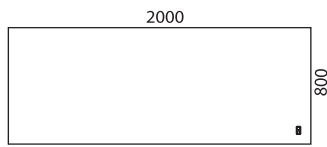
	Colour stand	Description	White HPL (31)	Optional HPL (39)	Lineoleum (88)	Veneer group 1	Veneer group 2
Desk top incl electrical T-legs (61-126 cm)	White	53B xx xxxxx 31-E	2 183	2 297	2 382	2 189	2 284
	Black	53B xx xxxxx 37-E	2 183	2 297	2 382	2 189	2 284
Desk top only		53B xx xxxxE	521	635	721	528	623

OPTIONS:

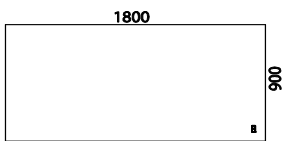
Additional cost for cable box			293	293	293	293	293
-------------------------------	--	--	-----	-----	-----	-----	-----



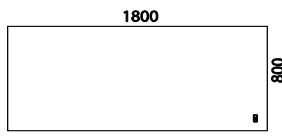
5306E



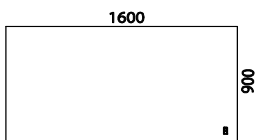
5305E



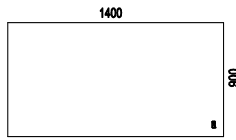
5304E



5303E



5302E



5311E

Nomono T Design: Fredrik Mattson

E Desks within size 1600x800 mm

Complete package with desk top, frame and electrical T-legs.

Please replace the first 2 xx in the article number with the material code for the desk top.
Next 4 xxxx should be replaced with the code for the desk (the code under the desk symbol)

	Colour stand	Description	White HPL (31)	Optional HPL (39)	Lineoleum (88)	Veneer group 1	Veneer group 2
Desk top incl electrical T-legs (61-126 cm)	White	53E xx xxxxx 31-E	2 145	2 180	2 311	2 164	2 258
	Black	53E xx xxxxx 37-E	2 145	2 180	2 311	2 164	2 258
Desk top only		53E xx xxxxE	484	519	650	502	597

OPTIONS:

Additional cost for cable box			293	293	293	293	293
-------------------------------	--	--	-----	-----	-----	-----	-----

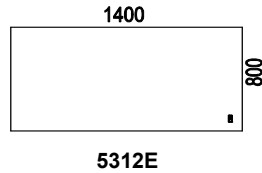
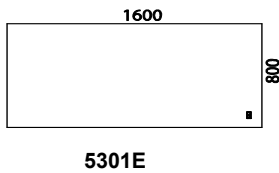


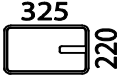
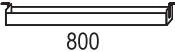





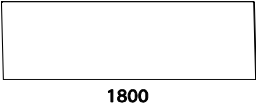
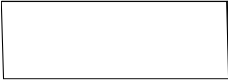

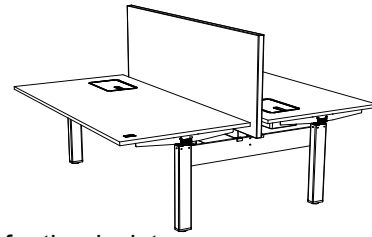
Illustration	Description	Article number	Material	EUR
Nomono T Design: Fredrik Mattson				
Nomono T ACCESSORIES		31 White	Closest NCS: S 0300-N	
		37 Black	S 9000-N	
	Extra cost for shutter on desk top. Incl. 3-way standard socket and cable pipe in textile. The cable lid is made of the same material as the desk top, with MDF edges.	53 31 5300xx 53 39 5300xx 53 88 5300xx 53 xx 5300xx 53 xx 5300xx	White HPL Optional HPL Lineleum Veneer gr 1 Veneer gr 2	293 293 293 293 293
	Cable tray. Length 800 mm. Adjustable in 3 heights	29 31 142 29 37 142	White Black	102 102
	Arm with assembled plastic pen drawer (white or black) for mounting in desk top or on rail.	53 31xx 01149 53 37xx 01149	White arm Black arm	137 137
	Single plastic pen drawer	53 31 01149 53 37 01149	White Black	63 63
	Arm with assembled plastic mail drawer (white or black) for mounting in desk top or on rail.	53 31xx 01148 53 xx 01148	White arm Black arm	137 137
	Single plastic mail drawer	53 31 01148 53 37 01148	White Black	63 63
	Arm with laptop holder, for mounting in desk top or on rail <i>* outgoing product</i>	53 31 02526 53 37 02526	White * Black *	155 155

Illustration	Description	Article number	Material	EUR
<p>Nomono T FABRIC DESK SCREENS</p> <ul style="list-style-type: none"> • For mounting in desk top • Thickness approx. 35 mm, of which 30 mm are sound absorbent • Height over desk: 450 mm • Brackets to be ordered separately. • For fabric codes: please see the supplier's website 				
<p>Price group 1: <u>Camira:</u> Cara, Carlow <u>Gabriel:</u> Event Screen, Hush</p>	<p>Price group 2: <u>Camira:</u> Blazer Lite <u>Gabriel:</u> Soul, Soul Mel., Twist, Twist Mel. <u>Kvadrat:</u> Hint <u>Nevotex:</u> Slope</p>	<p>Price group 3: <u>Camira:</u> Blazer, Main Line Flax <u>Gabriel:</u> Bond, Rondo <u>Kvadrat:</u> Remix, Remix Screen, Floyd Screen <u>Nevotex:</u> Lido, Lido Trend, Wooly Wide</p>		
 <p>1800 600</p>	<p>Sound absorbing desk screen, Length 1800 mm, excluding brackets</p> <p>Brackets</p>	<p>34 97 81800-x</p> <p>34 37 06794-4</p>	<p>PG 1 PG 2 PG 3 black</p>	<p>380 459 526 93</p>
 <p>1600 600</p>	<p>Sound absorbing desk screen, Length 1600 mm, excluding brackets</p> <p>Brackets</p>	<p>34 97 81600-x</p> <p>34 37 06794-4</p>	<p>PG 1 PG 2 PG 3 black</p>	<p>320 374 471 93</p>
 <p>1400 600</p>	<p>Sound absorbing desk screen, Length 1400 mm, excluding brackets</p> <p>Brackets</p>	<p>34 97 81400-x</p> <p>34 37 06794-4</p>	<p>PG 1 PG 2 PG 3 black</p>	<p>309 364 434 93</p>

Nomono DUO Design: Fredrik Mattson

D NOMONO DUO



Complete package with 2 desk tops, frames and electrical legs.

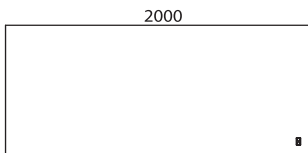
Please replace the first 2 xx in the article number with the material code for the desk top.
Next 4 xxxx should be replaced with the code for the desk (the code under the desk symbol)

	Colour	Description	White HPL (31)	Optional HPL (39)	Lineoleum (88)	Veneer group 1	Veneer group 2
B-format: 2000x900, 2000x800, 1800x900, 1800x800, 1600x900 mm: 2 desk tops including electrical legs. (60-125 cm)	White	53E xx xxxxx 31-D	4 042	4 271	4 440	4 055	4 243
	Black	53E xx xxxxx 37-D	4 042	4 271	4 440	4 055	4 243
E-format: 1600x800, 1400x800 mm: 2 desk tops including electrical legs. (60-125 cm)	White	53E xx xxxxx 31-D	3 966	4 036	4 299	4 004	4 193
	Black	53E xx xxxxx 37-D	3 966	4 036	4 299	4 004	4 193

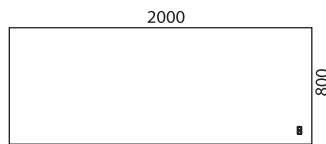
OPTIONS:

Cable lid incl plastic box, 2 pcs	53xx5300xx	586	
Flexible cable tray incl. 2 x 3-Power	52xx06990	283	
Lid for flex. Cable tray	53xx03792	90	
Desk screen	See next page		

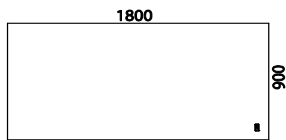
B-format



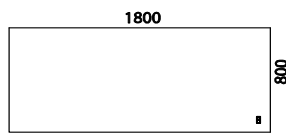
5306E



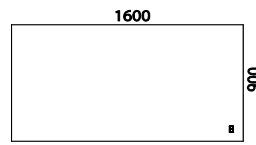
5305E



5304E

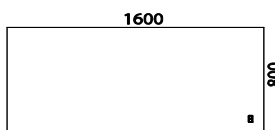


5303E

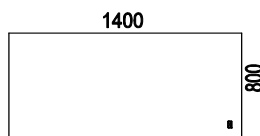


5302E


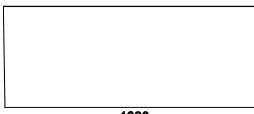
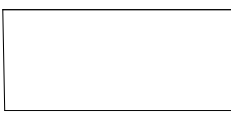
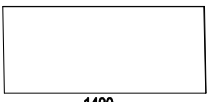
E-format



5301E



5312E

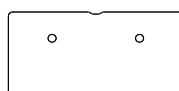
<p>Nomono T FABRIC DESK SCREENS TO NOMONO DUO</p> <ul style="list-style-type: none"> • Thickness approx. 35 mm, of which 30 mm are sound absorbent • Fixed height from floor: 120 cm • Brackets to be ordered separately. Choose white or black. • For fabric codes: please see the supplier's website 				
<p>Price group 1: <u>Camira:</u> Cara, Carlow <u>Gabriel:</u> Event Screen, Hush</p>	<p>Price group 2: <u>Camira:</u> Blazer Lite <u>Gabriel:</u> Soul, Soul Mel., Twist, Twist Mel. <u>Kvadrat:</u> Hint <u>Nevotex:</u> Slope</p>	<p>Price group 3: <u>Camira:</u> Blazer, Main Line Flax <u>Gabriel:</u> Bond, Rondo <u>Kvadrat:</u> Remix, Remix Screen, Floyd Screen <u>Nevotex:</u> Lido, Lido Trend, Wooly Wide</p>		
 <p>2000 650</p>	<p>Sound absorbing desk screen Lenght 2000 mm, excl brackets</p> <p>Brackets</p>	<p>34 97 07416-x</p> <p>52 xx 07008</p>	<p>PG 1 PG 2 PG 3 white/black</p>	<p>524 619 699 114</p>
 <p>1800 650</p>	<p>Sound absorbing desk screen Lenght 1800 mm, excl brackets</p> <p>Brackets</p>	<p>34 97 07119-x</p> <p>52 xx 07008</p>	<p>PG 1 PG 2 PG 3 white/black</p>	<p>437 515 583 114</p>
 <p>1600 650</p>	<p>Sound absorbing desk screen Lenght 1600 mm, excl brackets</p> <p>Brackets</p>	<p>34 97 07118-x</p> <p>52 xx 07008</p>	<p>PG 1 PG 2 PG 3 white/black</p>	<p>377 431 528 114</p>
 <p>1400 650</p>	<p>Sound absorbing desk screen Lenght 1400 mm, excl brackets</p> <p>Brackets</p>	<p>34 97 07117-x</p> <p>52 xx 07008</p>	<p>PG 1 PG 2 PG 3 white/black</p>	<p>367 420 491 114</p>

Siglo Design: Henrik Schulz**Siglo** DESK TOPS

- Siglo desk tops in veneer, laminate and linoleum are made of 19 mm MDF with a straight pp-edge. White edge to veneer and matching edge to laminate and linoleum. Additional cost for chamfered edge.
- Siglo desk tops in white direct lam. are made of 19 mm particle board with straight pp-edge.
- Radius 35 mm.
- Siglo has a cut-out for cables as standard. Cable holes against additional fee.

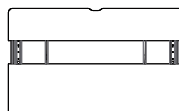
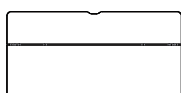


Standard



Med kabelhål (tillval)

- Electric stand, VX11, to be ordered separately. White, black and silver, range 65 cm.
- Siglo has a cut-out for cables as standard. Cable holes against additional fee.

• **Linoleum Forbo Flooring:**

4132 Ash	5502-G
4154 Burgundy	7010-R10B
4166 Charcoal	8502-B
4172 Mauve	7005-Y80R
4174 Conifer	8010-B90G
4175 Pebble	3502-Y
4176 Mushroom	2002-Y
4177 Vapour	2005-G10Y
4179 Smokey Blue	7010-R90B
4184 Olive	5010-G50Y

• **Veneer group 1:**

Oak nature (03)
Ash nature (06)

• **Veneer group 2:**

White pigmented oak (30)
White pigmented ash (10)
Black stained ash (86)
Dark stained ash (76)
Burgundy stained ash (C8)
Conifer stained ash (D3)
Smokey Blue stained ash (D4)

• **High Pressure laminate:**

Closest NCS:

White HPL (standard 0754)	S0502-Y
Light grey HPL (opt. lam 0419)	S2002-Y
Light grey HPL (opt. lam 1365)	S2005-R80B
Medium grey HPL (opt. lam 1023)	S5500-N
Anthracite HPL (opt. lam 1397)	S7500-N
Black HPL (optional lam 2253)	S9000-N

- For additional product information please see www.horreds.se

Siglo Design: Henrik Schulz

B

Desks within size 1800x900 mm.

Desk tops Siglo with cut-out for cables.

Electric stand VX11 to be ordered separately.

Replace the first 2 xx in the article number with the material code for desk top.

Next 5 xxxxx should be replaced with the code for the desk required (the code under the desk symbol)

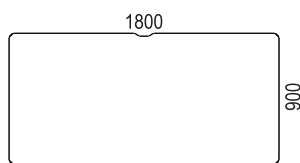
Desk tops Siglo:	Artikelnummer	White direct lam. (31D)	White HPL (31)	Optional HPL (39)	Lino-leum (88)	Veneer group 1	White oak (30) White ash (10) *
Siglo desk top	60B xx 16-xxxxx	310	453	549	701	425	501
* Stained only available with chamfered edge, additional cost:							86

Electric stand:

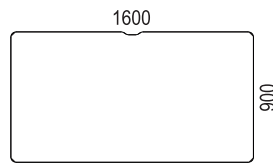
VX11, see page 44

Options:

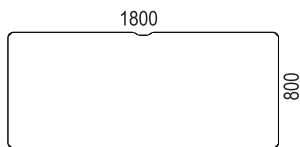
Chamfered edge Note: not in combination with direct laminate		20	86
Touchpad milled into desk top		343707444	55
Cable holes, incl. 2 lids, white/black	Plastic	60xx03118x2	150
Cable holes, incl. 2 lids	Brass	601603118x2	241
Cable holes, incl. 2 lids	Stainless	601703118x2	241



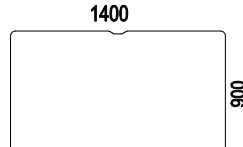
03436



03438



03435



03462

Siglo Design: Henrik Schulz

E Desks within size 1600x800 mm.

Desk tops Siglo with cut-out for cables.
Electric stand VX11 to be ordered separately.

Replace the first 2 xx in the article number with the material code for desk top.
Next 5 xxxxx should be replaced with the code for the desk required (the code under the desk symbol)

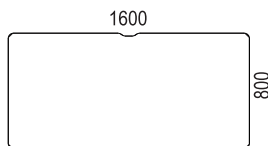
Desk tops Siglo:	Artikelnummer	White direct lam. (31D)	White HPL (31)	Optional HPL (39)	Lino-leum (88)	Veneer group 1	White oak (30) White ash (10) *
Siglo desk top	60E xx 16-xxxxx	299	397	461	650	397	469
* Stained only available with chamfered edge, additional cost:							86

Electric stand:

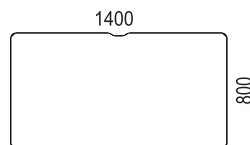
VX11, see page 44

Options:

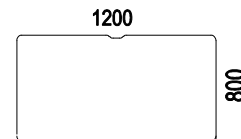
Chamfered edge Note: not in combination with direct laminate		20	86
Touchpad milled into desk top		343707444	55
Cable holes, incl. 2 lids, white/black	Plastic	60xx03118x2	150
Cable holes, incl. 2 lids	Brass	601603118x2	241
Cable holes, incl. 2 lids	Stainless	601703118x2	241



03115



03461

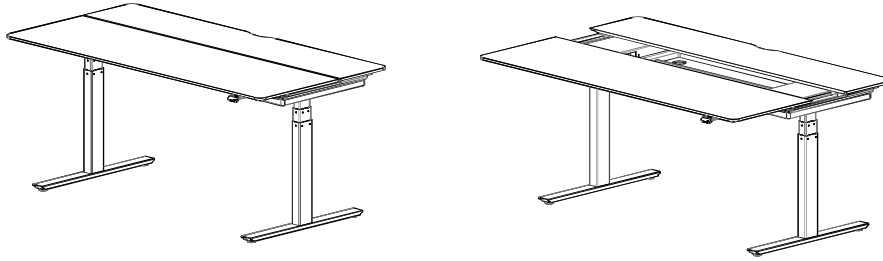


03950*

* ej möjlig med falsad kant

Siglo Design: Henrik Schulz

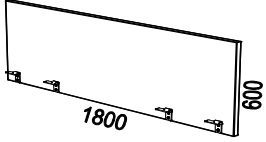
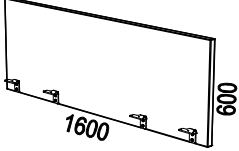
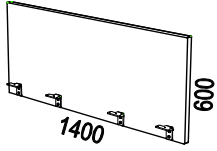
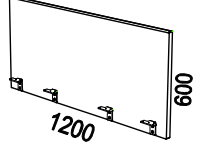
S Sliding desk



Complete package including sliding desk top with chamfered edge, frame, electrical T-legs VX8 and grey felt box.

xx in the article number should be replaced with the material code for the desk top.

		Article number	White direct lam. (31D)	White HPL (31)	Optional HPL (39)	Lino-leum (88)	Veneer group 1	Veneer group 2
1800x800:								
Sliding top 1800x800 with electrical adjustable T-legs (61-126 cm)* and grey felt box (art 6003609-2)	White	60B xx 20-03615-31S65		3 253	3 392	3 444	3 128	3 205
	Black	60B xx 20-03615-37S65		3 253	3 392	3 444	3 128	3 205
	Silver	60B xx 20-03615-38S65		3 253	3 392	3 444	3 128	3 205
1600x800:								
Sliding top 1600x800 with electrical adjustable T-legs (61-126 cm)* and grey felt box (art 6003608-2)	White	60E xx 20-03614-31S65		3 166	3 243	3 312	3 041	3 112
	Black	60E xx 20-03614-37S65		3 166	3 243	3 312	3 041	3 112
	Silver	60E xx 20-03614-38S65		3 166	3 243	3 312	3 041	3 112
1400x800:								
Sliding top 1400x800 with electrical adjustable T-legs (61-126 cm)* and grey felt box (art 6003607-2)	White	60E xx 20-03613-31S65		3 144	3 221	3 290	3 019	3 091
	Black	60E xx 20-03613-37S65		3 144	3 221	3 290	3 019	3 091
	Silver	60E xx 20-03613-38S65		3 144	3 221	3 290	3 019	3 091
Options:								
Electronic lock Mifare 13,56 Mhzfor sliding desk incl 1 user card (also includes 1 program card 371401 and 1 service card 371501 per order)		60372020		438				
Extra user card		371781		17				

Illustration	Description	Article number	EUR			
Siglo Design: Henrik Schulz						
<p>Siglo SOUND ABSORBING DESK SCREEN</p> <ul style="list-style-type: none"> • Height 600 mm (of which 500 mm over desk) • Thickness 35mm • Including black fittings • 3 different price groups • Also fits sliding desk • For additional product information; please see www.horreds.se 						
<p>Price group 1: <u>Camira:</u> Cara, Carlow <u>Gabriel:</u> Event Screen, Hush</p>		<p>Price group 2: <u>Camira:</u> Blazer Lite <u>Gabriel:</u> Soul, Soul Mel, Twist, Twist Mel. <u>Kvadrat:</u> Hint <u>Nevotex:</u> Slope</p>		<p>Price group 3: <u>Camira:</u> Blazer, Main Line Flax <u>Gabriel:</u> Bond, Rondo <u>Kvadrat:</u> Remix, Remix Screen, Floyd Scr. <u>Nevotex:</u> Lido, Lido Trend, Wooly Wide</p>		
	<p>Sound absorbing desk screen 1800x600 mm incl black fittings</p>	<p>60 97 81800-xxx</p>	<p>PG 1 570</p>	<p>PG 2 676</p>	<p>PG 3 775</p>	
	<p>Sound absorbing desk screen 1600x600 mm incl black fittings</p>	<p>60 97 81600-xxx</p>	<p>496</p>	<p>566</p>	<p>711</p>	
	<p>Sound absorbing desk screen 1400x600 mm incl black fittings</p>	<p>60 97 81400-xxx</p>	<p>478</p>	<p>552</p>	<p>658</p>	
	<p>Sound absorbing desk screen 1200x600 mm incl black fittings</p>	<p>60 97 81200-xxx</p>	<p>463</p>	<p>537</p>	<p>606</p>	

HORREDS WORK DESKS

Here is a presentation of our work desks.

For information on desk materials and stands, see next page.



VX

- VX desk tops are made of 19 mm MDF with edging in matching colour.
- Corner radius 0 mm.
- Option: chamfered edge
- Option: cable entries
- Option: sliding desk
- Option: Horreds height adjustment control milled in desk top (touchpad).



Henry Design: sandellsandberg

- Henry desk tops are made of 19 mm MDF with white plastic edge.
- Corner radius 40 mm.
- Cable holes with slot as standard unless otherwise stated in the order.
- Option: Horreds height adjustment control milled in desk top (touchpad).



Fri Design: Bror Boije

- Fri desk tops are made of 19 mm MDF with chamfered, clear coated edge.
- Corner radius 30 mm.
- Option: cable entries
- Option: Horreds height adjustment control milled in desk top (touchpad).



• Desk material:

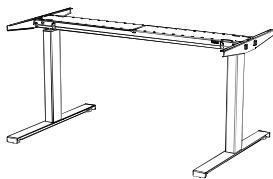
• High Pressure laminate:	Closest NCS:	Linoleum:	Closest NCS:	Veneer group 1:
White HPL (standard 0754)	S0502-Y	4132 Ash	5502-G	Birch (05)
Light grey HPL (opt. lam 0419)	S2002-Y	4154 Burgundy	7010-R10B	Oak (03)
Light grey HPL (opt. lam 1365)	S2005-R80B	4166 Charcoal	8502-B	Ash (06)
Medium grey HPL (opt. lam 1023)	S5500-N	4172 Mauve	7005-Y80R	Veneer group 2:
Anthracite HPL (opt. lam 1397)	S7500-N	4174 Conifer	8010-B90G	White pigmented oak (30)*
Black HPL (optional lam 2253)	S9000-N	4175 Pebble	3502-Y	White pigmented ash (10)*
		4176 Mushroom	2002-Y	Black stained ash (86)*
		4177 Vapour	2005-G10Y	Dark stained ash (76)*
		4179 Smokey Blue	7010-R90B	Burgundy stained ash (C8)*
		4184 Olive	5010-G50Y	Conifer stained ash (D3)*
				Smokey Blue st.ash (D4)*
				(*= <i>not Henry</i>)

• Electric stands:



VX11:

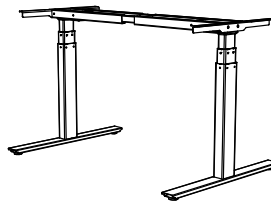
- Range 65 cm (desk height 61-126 cm)
- White (RAL9016) / Black (RAL9005) / Silver (RAL9006)
- Flexible frame 1156-1756 mm (black RAL9005)
- Lift capacity 160 kg, incl table top, in widened weight
- Only 0,1 w power consumption in standby mode
- PVC-free
- Anti-collision protection (DS1)
- Soft start/stop
- Integrated electronics
- Feet length 710 mm and 560 mm
- Fast click assembly



VX11

VX8:

- Range 65 cm (desk height 61-126 cm)
- White (RAL9016) / Black (RAL9005)
- Flexible frame (black RAL9005) *
- Lift capacity 160 kg, incl table top, in widened weight
- Only 0,1 w power consumption in standby mode
- PVC-free
- Anti-collision protection (Piezo)
- Soft start/stop
- Transformator with possibility of programming
- Feet length 700 mm and 550 mm
- Option: massive feet



X8

• Stand with fixed height:

VX10:

- Fixed height 73 cm
- White (RAL9016) / Black (RAL9005) / Silver (RAL9006)
- Black frame (Black RAL 9005) *
- Feet lengths 700 and 550 mm.

• For additional product information please see www.horreds.se

HORREDS WORK DESKS

E Desks within size 1600X800 mm.

Note: Table tops and frames are priced separately.

When ordering please supply following information:

1) Size/shape/material/edge of the desk top and 2) colour, range and article number of the stand.

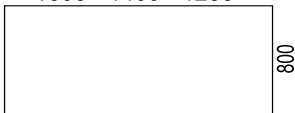
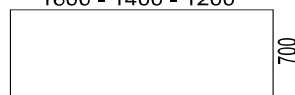
Table top (excluding stand)	art nr	White HPL (31)	Optional HPL (39)	Linoleum (88)	Veneer group 1	Veneer group 2
Series: Radius: Edge profile:						
VX (3416) 0 mm Straight / matching list	34xx16xxxxE	446	499	609	464	555
VX (3417) 0 mm Chamfered / matching list	34xx17xxxxE	558	611	721	576	667
Henry (80) 40 mm Straight/white pp-list, inc cable hole	80xxxxxxE	477	532	691	502	
Fri (3513) 30 mm Chamfered / MDF	35xx13xxxxE	490	544	703	461	556
<i>Option: Horreds touchpad</i>	343707444	55	55	55	55	55

Cable holes: Henry has cable hole with slot as standard, for VX and Fri it is optional.

Stands (excl.table top)	Art nr	White (31)	Black (37)	Silver (38)
VX11 electric stand, range 65 cm, feet 71 cm	VX11xx657-1	605	605	605
VX11 electric stand, range 65 cm, feet 56 cm	VX11xx655-1	605	605	605
VX8 electric stand, range 65 cm	VX8xx2657F2	1 193	1 193	
VX10 fixed height 73 cm	VX10xx2007F2	602	602	602
<i>Upcharge massive feet 700 mm to VX8+VX10</i>		202	202	

Below you find our standard desk tops within this format. There might be optional desks available in our table bank.

Please contact Customer Service (info@horreds.se) to check availability. If you would like to order a model which is not available in the table bank there will be an additional cost of € 110.

Rectangular (mm):		Drawing number:		
		VX	Henry	Fri
<div style="display: flex; align-items: center;"> <div style="text-align: center; margin-right: 10px;">1600 - 1400 - 1200</div>  </div>	1600x800	7025	8402	2068
	1400x800	7024	8419	2067
	1200x800	7023	8523	2066
<div style="display: flex; align-items: center;"> <div style="text-align: center; margin-right: 10px;">1600 - 1400 - 1200</div>  </div>	1600x700	7063	8542	2153
	1400x700	7109	8421	2245
	1200x700	7183	8594	2846

HORREDS WORK DESKS

B Desks within size 2000X900 mm.

Note: Table tops and frames are priced separately.

When ordering please supply following information:

1) Size/shape/material/edge of the desk top and 2) colour, range and article number of the stand.

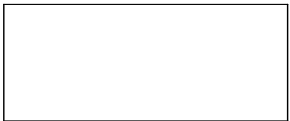
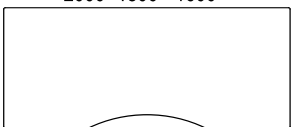

Table top (excluding stand)	art nr	White HPL (31)	Optional HPL (39)	Linoleum (88)	Veneer group 1	Veneer group 2
Series: Radius: Edge profile:						
VX (3416) 0 mm Straight / matching list	34xx16xxxxB	482	592	702	488	579
VX (3417) 0 mm Chamfered / matching list	34xx17xxxxB	594	704	814	600	690
Henry (80) 40 mm Straight/white pp-list, inc cable hole	80xxxxxB	515	629	788	528	
Fri (3513) 30 mm Chamfered / MDF	35xx13xxxxB	528	642	801	487	581
<i>Option: Horreds touchpad</i>	343707444	55	55	55	55	55

Cable holes: Henry has cable hole with slot as standard, for VX and Fri it is optional.

Stands (excl.table top)	Art nr	White (31)	Black (37)	Silver (38)
VX11 electric stand, range 65 cm NB: max desk length 1800 mm.	VX11xx657-1	605	605	605
VX8 electric stand, range 65 cm	VX8xx2657F2	1 193	1 193	
VX10 fixed height 73 cm	VX10xx2007F2	602	602	602
<i>Upcharge massive feet 700 mm to VX8+VX10</i>		202	202	

Below you find our standard desk tops within this format. There might be optional desks available in our table bank.

Please contact Customer Service (info@horreds.se) to check availability. If you would like to order a model which is not available in the table bank there will be an additional cost of € 110.

Drawing number:	Rectangular (mm):		Drawing number:		
			VX	Henry	Fri
	2000 - 1800 - 1600	2000x900	7037	8403	2341
		2000x800	7027	8404	2069
		1800x900	7036	8405	2662
		1800x800	7026	8401	2028
		1600x900	7035	8408	2729
	Magbord (mm):				
		2000x900			2447
		1800x900			3149
	Magbord (mm):				
		2000x900			3701
		1800x900			3013
	1600x900			2980	

HORREDS WORK DESKS

C Desks within size 1200X600 mm.

Note: Table tops and frames are priced separately.

When ordering please supply following information:

1) Size/shape/material/edge of the desk top and 2) colour, range and article number of the stand.

Table top (excluding stand)	art nr	White HPL (31)	Optional HPL (39)	Linoleum (88)	Veneer group 1	Veneer group 2
Series: Radius: Edge profile:						
VX (3416) 0 mm Straight / matching list	34x16xxxxC	395	425	513	392	482
VX (3417) 0 mm Chamfered / matching list	34x17xxxxC	507	537	625	504	594
Henry (80) 40 mm Straight/white pp-list, inc cable hole	80xxxxxC	426	559	594	430	
Fri (3513) 30 mm Chamfered / MDF	35x13xxxxC	439	465	607	389	484
<i>Option: Horreds touchpad</i>	343707444	55	55	55	55	55

Cable holes: Henry has cable hole with slot as standard, for VX and Fri it is optional.





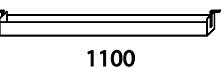
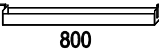

Stands (excl.table top)	Art nr	White (31)	Black (37)	Silver (38)
VX11 electric stand, range 65 cm	VX11xx655-1	605	605	605
VX8 electric stand, range 65 cm	VX8xx2655F2	1 193	1 193	
VX10 stand, fixed height 73 cm	VX10xx2005F2	602	602	602

Below you find our standard desk tops within this format. There might be optional desks available in our table bank.

Please contact Customer Service (info@horreds.se) to check availability. If you would like to order a model which is not available in the table bank there will be an additional cost of € 110.


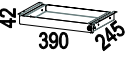
	Rectangular (mm):	Drawing number:		
		VX	Henry	Fri
	1200x600	7013	8513	2162
1000x600	7012	8567	2139	

Illustration	Description	Article number	Material	EUR					
CABLE ENTRIES & CABLE TRAYS FOR DESKS									
<ul style="list-style-type: none"> • For desks in series Fri and VX. • If other entry than our standard; please contact customer service for price. 									
				Entry codes					
	Cable entry 80 mm, incl lid in plastic, stainless steel look	2913800	Colour:	Y1	Y2	Y3	Y4	Y5	Y8
			chrome	35	35	35	45	45	45
	Lid only	2913800L		10					
	Cable entry 80 mm, including lid in plastic	3938850	grey	32	32	32	38	38	38
		3931850	white	32	32	32	38	38	38
		3937850	black	32	32	32	38	38	38
	Lid only	573880	grey	6					
		573180	white	6					
573780		black	6						
	Powerdot cable entry 80 mm with 1xpower and 4 Magic Holes	935-PD10	black	Y1	Y2	Y3			
		935-PD10W	white	66	66	66			
	Powerdot cable entry 80 mm 1xpower and 2 xUSB-A charger. Adjustable 3 levels	935-PD14	black	148	148	148			
		935-PD14W	white	148	148	148			
	Powerdot cable entry 80 mm. 1 power, 1 USB-A charger, 1 USB-C, 2 magic holes. Adjustable 2 levels.	935-PD16	black	169	169	169			
		935-PD16W	white	169	169	169			
	USB-C charger 20 W, for 935-PD16.	935-PUSBC20	Black	62	62	62			
	Powerdot cable entry 60 mm 1 x power + 1 x USB-A charger	935-PM61	Black	F1	F2	F3			
		935-PM61W	White	103	103	103			
	Powerdot cable entry 60 mm 1 x power + 1 x USB-C PD charger	935-PM62	Black	144	144	144			
		935-PM62W	White	144	144	144			
	Axessline cordless charger ø 60 mm. Qi-standard for smartphones	935-QI60B	Black	176	176	176			
		935-QI60W	White	176	176	176			

Illustration	Description	Article number	Material	EUR		
				Entry codes		
				D1	D2	D3
	Powerdot cable entry 51 mm. 1 power.	935-PM50 935-PM50W	black	63	63	63
			white	63	63	63
	Powerdot cable entry 51 mm. 2 x USB-A charger	935-PM51 935-PM51W	black	98	103	103
			white	103	103	103
	Powerdot cable entry 51 mm. 2 x USB-C PD charger	935-PM52 935-PM52W	black	144	144	144
			white	144	144	144
				0	0	0
	Powerdot cable entry 30 mm 2 x USB-A charger	935-PM30 935-PM30W	black	J1 89	J2 89	J3 89
			white	89	89	89
	Powerdot cable entry 30 mm 1 x USB-A and 1 USB-C charger	935-PM32 935-PM32W	black	140	140	140
			white	140	140	140
	Cable entry including lid 233x128 in Same material as desk top Note: no matching of veneer	57xx6253K		R1 center 131	R2 right 131	R3 left 131
	Cable entry, customized (without lid)	HAL1		115		
 1100	Cable tray. Length 1100 mm. Adjustable 3 heights.. Minimum desk length: 1400 mm.	2937140 2931140 2938140	black	102		
			white	102		
			silver	102		
 800	Cable tray. Length 800 mm. Adjustable 3 heights.	2937142 2931142 2938142	black	102		
			white	102		
			silver	102		
	Power socket, 3-ways, with bracket.	343707434	black	97		
	Power socket 3-ways, 3 m cable	936-E3V30B	black	27		
	Power socket 6-ways, 3 m cable	936-E6V30B	black	32		
	Cable pipe in textile. Length 1500 mm.	29371500 29311500	black	119		
			white	119		
	Cable cover 1300 mm fabric Gabriel Runner 60999	341300-600	Black	87		

ACCESSORIES DESKS

• For additional product information: please see www.horreds.se

 44 873 260	Metallic pen drawer 390x245x42 mm,	4048	Black	229
 44 390 245	Metallic pen drawer 390x245x42 mm, with lock.	4015-L	Black	191

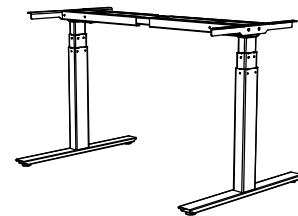
VX8 & VX11**VX8 & VX11 STANDS**

VX8 is the premium option of our stands with anti-collision function as standard, and with transformer with programming capability as option.

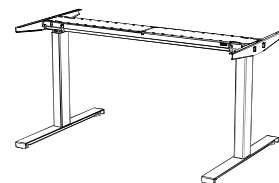
VX11 is a stand with easy mounting. The four parts of the concept are carefully designed to either be clicked together or fastened with a few screws. The frame is the heart of the system since the motor, electronics and cabling are already pre-assembled in the frame.

VX8 ELECTRICAL STAND

- Has only 0,1 w power consumption in standby mode and is completely PVC-free.
- Can be preprogrammed, e.g. at different elevation intervals, has Pieze (anti-collision protection) soft start/stop. Via programs on your computer or via an app, you can control your table.
- Range 65 cm (table height 61-126 cm)
- Lift capacity 160 kg, including table top, in widened weight.
- Complete stand with legs, feet, black flexible frame and hand control under the table.
- Optional: touchpad (hand control milled into desk top)
- Optional: massive feet
- Table tops are ordered separately. Choose from our series VX, Henry and Fri.
- Colours: White (RAL9016) / Black (RAL9005)

**VX11 ELECTRICAL STAND**

- Has only 0,1 w power consumption in standby mode and is completely PVC-free.
- With anti-collision protection (DS1) and soft start/stop.
- Range 65 cm (table height 61-126 cm)
- Lift capacity 160 kg, including table top, in widened weight.
- Complete stand with legs, feet, black flexible frame and hand control under the table.
- Optional: touchpad (hand control milled into desk top)
- Table tops are ordered separately. Choose from our series VX, Henry and Fri.
- Colours: White (RAL9016) / Black (RAL9005) / Silver (RAL 9006)

**VX T-BEN**

- Fixed height 73 cm.
- Complete stand with legs, feet, black frame.
- Colours: White (RAL9016) / Black (RAL9005) / Silver (RAL 9006)
- Table tops are ordered separately. Choose from our series VX, Henry and Fri.

- For additional product information please see www.horreds.se

Description	Art.nr	EUR
<p>VX STANDS WITH T-LEGS</p> <p>VX11 with desk depth 800-900 mm is delivered with T-foot 710 mm VX11 with desk depth 600-700 mm is delivered with T-foot 560 mm VX8 with desk depth 700-900 mm is delivered with T-foot 700 mm VX8 with desk depth 600 mm is delivered with T-foot 550 mm</p>		

VX11		White (31)	Black (37)	Silver (38)
<p>T-stand with flexible frame 1156-1756 mm, feet 710 mm Fits desk tops in length 1200-1800 mm and depth 800-900 mm. VX11 electric stand, range 65 cm</p>	VX11xx65x-1	605	605	605
Disassembly tool VX11	SA1023W1241		19	

VX8		White (31)	Black (37)	Silver (38)
<p>T-stand with flexible frame 1070-1600 mm, feet 700 alt. 550 mm Fits desk tops in length 1400-1800 mm and depth 600-900 mm. VX8 electric stand, range 65 cm</p>	VX8xx265xF2	1 193	1 193	
VX fixed stand, height 73 cm	VX10xx200xF2	602	602	602
<p>T-stand with flexible frame 1530-2000 mm, feet 700 alt 550 mm. Fits desk tops in length 2000-2200 mm and depth 600-900 mm. VX8 electric stand, range 65 cm</p>	VX8xx265xF3	1 193	1 193	
VX fixed stand, height 73 cm	VX10xx200xF3	602	602	602
<p>T-stand with flexible frame 1000-1500 mm, feet 700 alt 550 mm. Fits desk tops in length 1200 mm and depth 600-900 mm. VX8 electric stand, range 65 cm</p>	VX8xx265xF1	1 193	1 193	
VX fixed stand, height 73 cm	VX10xx200xF1	602	602	602
Option: upcharge for massive feet 700 mm	52xx02640	202	202	



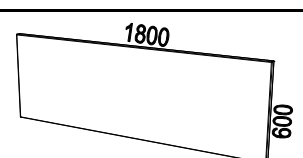
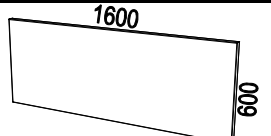
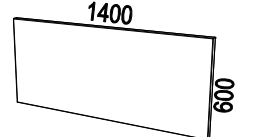
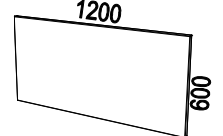
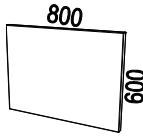
Illustration	Description	Article number	EUR		
VX					
	<p>VX sound absorbing desk screen</p> <ul style="list-style-type: none"> • Height 600 mm (of which 500 mm over desk). • Two different corner edges: radius 0 and radius 50. • Thickness 35 mm, of which 30 mm sound absorber • Specification sound absorbent: <ul style="list-style-type: none"> - 30 mm polyester wadding (1000g/m2) - 100% polyester, up to 80% regenerated fibres - Certified according to Ökotex, class 1. • Max weight capacity 25 kg. • Fittings to be ordered separately. • Also suitable for desks Henry and Fri. • For fabric codes: please see the supplier's website • For additional product information, please see www.horreds.se 				
<p>Price group 1: Camira: Cara, Carlow Gabriel: Event Screen, Hush</p>		<p>Price group 2: Camira: Blazer Lite Gabriel: Soul, Soul Mel, Twist, Twist Mel. Kvadrat: Hint Nevotex: Slope</p>		<p>Price group 3: Camira: Blazer, Main Line Flax Gabriel: Bond, Rondo Kvadrat: Remix, Remix Screen, Floyd Scr. Nevotex: Lido, Lido Trend, Wooly Wide</p>	
			PG 1	PG 2	PG 3
	<p>Sound absorbing desk screen, radius 0, length 1800 mm, excl fittings</p> <p>Brackets, 4 pieces, black</p>	<p>34 97 81800-x</p> <p>34 37 06794-4</p>	380	459	526
	<p>Sound absorbing desk screen, radius 0, length 1600 mm, excl fittings</p> <p>Brackets, 4 pieces, black</p>	<p>34 97 81600-x</p> <p>34 37 06794-4</p>	320	374	471
	<p>Sound absorbing desk screen, radius 0, length 1400 mm, excl fittings</p> <p>Brackets, 4 pieces, black</p>	<p>34 97 81400-x</p> <p>34 37 06794-4</p>	309	364	434
	<p>Sound absorbing desk screen, radius 0, length 1200 mm, excl fittings</p> <p>Brackets, 4 pieces, black</p>	<p>34 97 81200-x</p> <p>34 37 06794-3</p>	299	353	400
	<p>Sound absorbing side screen, radius 0, length 800 mm, excl fittings</p> <p>Brackets, 2 pieces, black</p>	<p>34 97 08354-x</p> <p>34 37 06780</p>	200	237	268

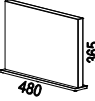
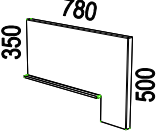

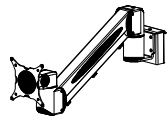

Illustration	Description	Article number	EUR		
			PG 1	PG 2	PG 3
	Sound absorbing desk screen, 480x365x35 mm. Incl foot in laquered steel. Choose colour of foot: white or black.	34 xx 03374-x	292	310	338
	Sound absorbing desk screen, 780x365x35 mm. Incl foot in laquered steel. Choose colour of foot: white or black.	34 xx 06360-x	362	398	434
Accessories to VX desk screens					
			Material	EUR	
	Rail for accessories.				
	Freewall 1750 mm	670 175	Silver	175	
	Freewall 1550 mm	670 175-1	White	175	
	Freewall 1350 mm	670 155	Silver	160	
	Freewall 1350 mm	670 155-1	White	160	
	Monitorarm D-Zine Toolbar 3 (1,5-8,5 kg) To be attached in Freewall. VESA 75 and 100.	670 135	Silver	141	
		670 135-1	White	141	
Accessories to VX desk screen on foot					
	Pen tray for freestanding side screen	34 31 03357	White	68	
		34 37 03357	Black	68	


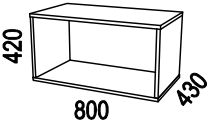
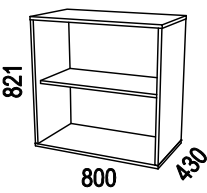
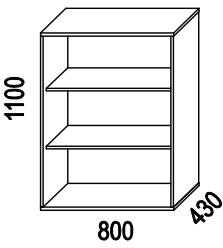
Illustration	Description	Article number	Material	EUR
<p style="text-align: center;">STORAGE BASIC UNITS</p>  <ul style="list-style-type: none"> • Basic unit in direct laminated or veneered particle board • White direct laminate = closest NCS S0300-N • Stationary shelves • For additional product information; please see www.horreds.se <p><u>Veneer group 1:</u> Birch (05), Oak (03), Ash (06).</p> <p><u>Veneer group 2:</u> White pigmented Oak (30), White pigmented Ash (10), Black stained Ash (86), Dark stained Ash (76).</p> <p>Note! Price is for basic unit only</p> <ul style="list-style-type: none"> • Base to be ordered separately. • Sliding doors to be ordered separately. 				
WIDTH 800 MM:				
	<p>Basic unit 800x420x430 mm. 1xA4-height prepared for sliding doors.</p> <p>As above but not prepared for sliding doors</p>	<p>57 31 71310 57 xx 71310 57 xx 71310</p> <p>57 31 71300 57 xx 71300 57 xx 71300</p>	<p>White direct lam. Veneer group 1 Veneer group 2</p> <p>White direct lam. Veneer group 1 Veneer group 2</p>	<p>427 662 795</p> <p>427 662 795</p>
	<p>Basic unit 800x821x430 mm. 2xA4-height prepared for sliding doors.</p> <p>As above but not prepared for sliding doors</p>	<p>57 31 72310 57 xx 72310 57 xx 72310</p> <p>57 31 72300 57 xx 72300 57 xx 72300</p>	<p>White direct lam. Veneer group 1 Veneer group 2</p> <p>White direct lam. Veneer group 1 Veneer group 2</p>	<p>467 863 1 036</p> <p>467 863 1 036</p>
	<p>Basic unit 800x1100x430 mm. 3xA4-height prepared for sliding doors.</p> <p>As above but not prepared for sliding doors</p>	<p>57 31 73310 57 xx 73310 57 xx 73310</p> <p>57 31 73300 57 xx 73300 57 xx 73300</p>	<p>White direct lam. Veneer group 1 Veneer group 2</p> <p>White direct lam. Veneer group 1 Veneer group 2</p>	<p>596 1 181 1 416</p> <p>596 1 181 1 416</p>

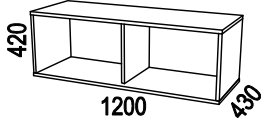
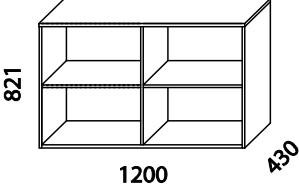
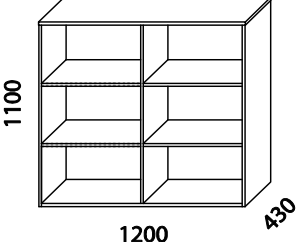
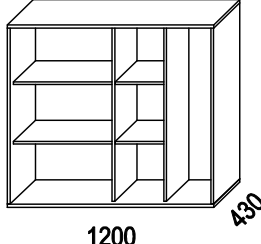
Illustration	Description	Article number	Material	EUR
WIDTH 1200 MM:				
	Basic unit 1200x420x430 mm. 1xA4-height prepared for sliding doors.	57 31 71510	White direct lam.	484
		57 xx 71510	Veneer group 1	877
		57 xx 71510	Veneer group 2	1 053
	As above but not prepared for sliding doors	57 31 71500	White direct lam.	484
		57 xx 71500	Veneer group 1	877
		57 xx 71500	Veneer group 2	1 053
	Basic unit 1200x821x430 mm. 2xA4-height prepared for sliding doors.	57 31 72510	White direct lam.	563
		57 xx 72510	Veneer group 1	1 159
		57 xx 72510	Veneer group 2	1 390
	As above but not prepared for sliding doors	57 31 72500	White direct lam.	563
		57 xx 72500	Veneer group 1	1 159
		57 xx 72500	Veneer group 2	1 390
	Basic unit 1200x1100x430 mm. 3xA4-height prepared for sliding doors.	57 31 73510	White direct lam.	643
		57 xx 73510	Veneer group 1	1 223
		57 xx 73510	Veneer group 2	1 468
	As above but not prepared for sliding doors	57 31 73500	White direct lam.	643
		57 xx 73500	Veneer group 1	1 223
		57 xx 73500	Veneer group 2	1 468
	Basic unit 1200x1100x430 mm with wardrobe compartment. 3xA4-height, prepared for sliding doors.	57 31 73512	White direct lam.	866
		57 xx 73512	Veneer group 1	1 531
		57 xx 73512	Veneer group 2	1 836

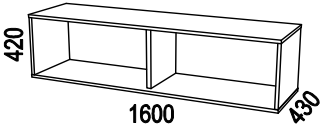
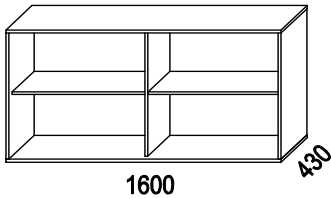
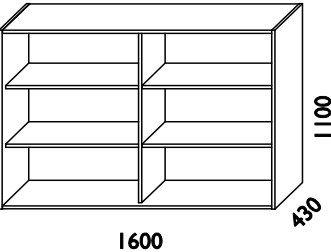
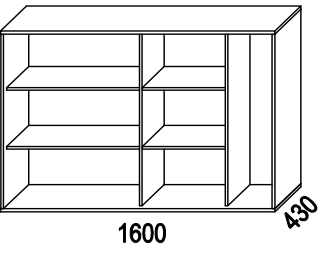
Illustration	Description	Article number	Material	EUR
WIDTH 1600 MM:				
	Basic unit 1600x420x430 mm. 1xA4-height, prepared for sliding doors.	57 31 71710	White direct lam.	616
		57 xx 71710	Veneer group 1	1 035
		57 xx 71710	Veneer group 2	1 242
	As above but not prepared for sliding doors	57 31 71700	White direct lam.	616
		57 xx 71700	Veneer group 1	1 035
		57 xx 71700	Veneer group 2	1 242
	Basic unit 1600x821x430 mm. 2xA4-height, prepared for sliding doors.	57 31 72710	White direct lam.	686
		57 xx 72710	Veneer group 1	1 395
		57 xx 72710	Veneer group 2	1 674
	As above but not prepared for sliding doors	57 31 72700	White direct lam.	686
		57 xx 72700	Veneer group 1	1 395
		57 xx 72700	Veneer group 2	1 674
	Basic unit 1600x1100x430 mm. 3xA4-height, prepared for sliding doors.	57 31 73710	White direct lam.	858
		57 xx 73710	Veneer group 1	1 511
		57 xx 73710	Veneer group 2	1 813
	As above but not prepared for sliding doors	57 31 73700	White direct lam.	858
		57 xx 73700	Veneer group 1	1 511
		57 xx 73700	Veneer group 2	1 813
	Basic unit 1600x1100x430 mm with wardrobe compartment. 3xA4-height, prepared for sliding doors.	57 31 73712	Vit direktlaminat	1 016
		57 xx 73712	Faner grupp 1	1 866
		57 xx 73712	Faner grupp 2	2 239


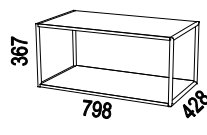
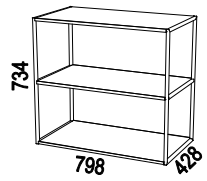
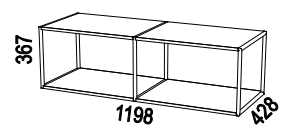
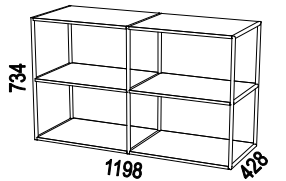
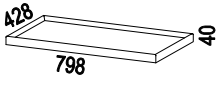
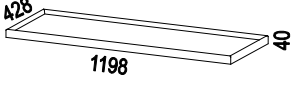
Illustration	Description	Article number	Material	EUR
Biblio Design: Anderssen & Voll				
 BIBLIO EXTENSION UNITS <ul style="list-style-type: none"> • Metallic extension unit I: white (RAL 9016 str) and black (RAL 9005 str) • Shelves: <ul style="list-style-type: none"> -White lacquer NCS S0300-N -Veneer group 1: Oak (03), Ash (06) - Veneer group 2: Black ash (86), Dark ash (76), White oak (30), White ash (10) • For additional product information see www.horreds.se 				
	Extension unit 798x367x428 mm in white or black metal with shelves in white lacquer or veneer	64 xx31 -0801	White shelves	533
		64 xxxx -0801	Veneer gr 1 shelves	669
		64 xxxx -0801	Veneer gr 2 shelves	714
	Extension unit 798x734x428 mm in white or black metal with shelves in white lacquer or veneer	64 xx31 -0802	White shelves	651
		64 xxxx -0802	Veneer gr 1 shelves	866
		64 xxxx -0802	Veneer gr 2 shelves	954
	Extension unit 1198x367x428 mm in white or black metal with shelves in white lacquer or veneer	64 xx31 -1201	White shelves	764
		64 xxxx -1201	Veneer gr 1 shelves	1 028
		64 xxxx -1201	Veneer gr 2 shelves	1 130
	Extension unit 1198x734x428 mm in white or black metal with shelves in white lacquer or veneer	64 xx31 -1202	White shelves	1 093
		64 xxxx -1202	Veneer gr 1 shelves	1 459
		64 xxxx -1202	Veneer gr 2 shelves	1 633
BIBLIO TRAYS <ul style="list-style-type: none"> • Tray in veneer with massive edges. -Veneer group 1: Oak (03), Ash (06) - Veneer group 2: Black ash (86), Dark ash (76), White oak (30), White ash (10) • For additional product information see www.horreds.se 				
	Tray 798x428x40 mm	64 xx 07525-	Veneer group 1	474
			Venner group 2	503
	Tray 1198x428x40 mm	64 xx 07525-	Veneer group 1	500
			Venner group 2	528


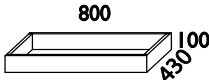
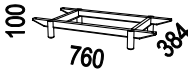
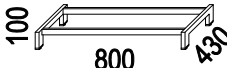


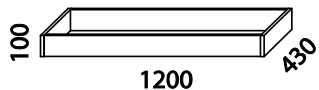
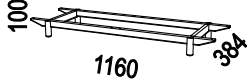
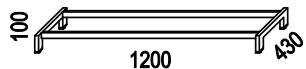

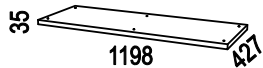
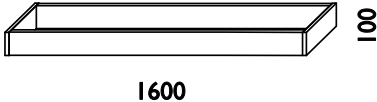
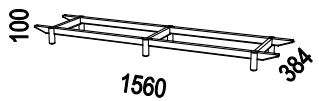
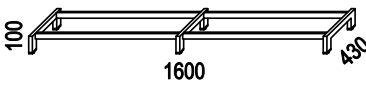

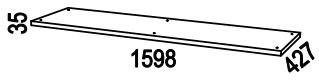
Illustration	Description	Article number	Material	EUR
<p>BASES</p>  <ul style="list-style-type: none"> • For basic units with depth 430 mm. • For additional product information; please see www.horreds.se <p><u>Veneer group 1:</u> Birch (05) Oak (03) Ash (06)</p> <p><u>Veneer group 2:</u> White pigmented Oak (30) White pigmented Ash (10) Black stained Ash (86) Dark stained Ash (76)</p>				
WIDTH 800 MM:				
	Base 800x100x430 mm	57 31 70310	White dir.lam.	119
		57 xx 70310	Veneer group 1	137
		57 xx 70310	Veneer group 2	164
	Leg base, solid wood, height 100 mm.	57 03 70340	Oak	315
		57 06 70340	Ash	315
		57 xx 70340	Veneer group 2	333
	Leg base 800x100x430 mm, steel	57 31 70330	White	213
		57 37 70330	Black	213
	Castors. Height 100 mm. For 800 mm wide storage (4 castors of which 2 lockable)	39 08 28	Grey/zink	66
	Base plate with small adjustable feet, 798x35x427 mm	57 31 70381	White dir.lam.	63
		57 xx 70381	Veneer group 1	96
		57 xx 70381	Veneer group 2	96
	Clamping knobs (4 pieces)	57 00 04-19		23

Illustration	Description	Article number	Material	EUR
WIDTH 1200 MM:				
	Base 1200x100x430 mm	57 31 70510 57 xx 70510 57 xx 70510	White dir.lam. Veneer group 1 Veneer group 2	130 168 201
	Leg base, solid wood, height 100 mm.	57 03 70540 57 06 70540 57 xx 70540	Oak Ash Veneer group 2	377 377 396
	Leg base 1200x100x430 mm, steel	57 31 70530 57 37 70530	White Blacke	226 226
	Castors. Height 100 mm. to 1600 mm wide storage (5 castors of which 2 lockable)	39 08 28-1	Grey/zink	84
	Base plate with small adjustable feet, 1198x35x427 mm	57 31 70581 57 xx 70581 57 xx 70581	White dir.lam. Veneer group 1 Veneer group 2	92 109 109
	Clamping knobs (6 pieces)	57 00 06-19		28
WIDTH 1600 MM:				
	Base 1600x100x430 mm	57 31 70710 57 xx 70710 57 xx 70710	White dir.lam. Veneer group 1 Veneer group 2	136 211 254
	Leg base, solid wood, height 100 mm.	57 03 70740 57 06 70740 57 xx 70740	Oak Ash Veneer group 2	483 483 501
	Leg base 1600x100x430 mm, steel	57 31 70730 57 37 70730	White Black	333 333
	Castors. Height 100 mm. to 1600 mm wide storage (6 castors of which 3 lockable)	39 08 28-2	Grey/zink	103
	Base plate with small adjustable feet, 1598x35x427 mm	57 31 70781 57 xx 70781 57 xx 70781	White dir.lam. Veneer group 1 Veneer group 2	99 121 121
	Clamping knobs (6 pieces)	57 00 06-19		28

Description	Article number	Material	EUR
-------------	----------------	----------	-----

Biblio Design: Anderssen & Voll**Biblio** SLIDING DOORS

- Sliding doors in lacquered or veneered MDF
- Handles in veneered steel
- Fronts in optional NCS: delivery time 6 weeks.
- Including lock with 2 keys
- For additional product information please see www.horreds.se

Note! Price is for sliding doors only.

- Basic unit and base to be ordered separately.

Material:**Veneer group 1:**

Oak (03)

Ash (06)

Veneer group 2:

White pigmented Oak (30)

White pigmented Ash (10)

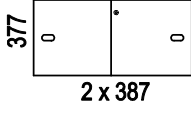
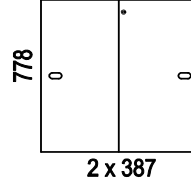
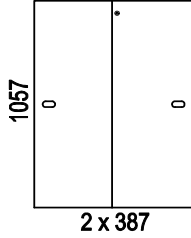
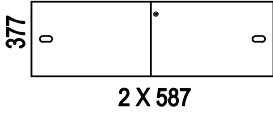
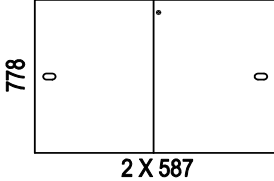
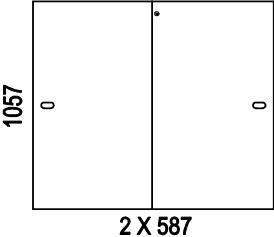
Black stained Ash (86)

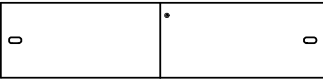
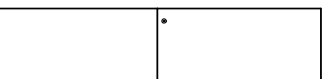
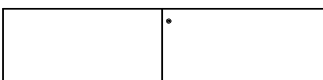
Dark stained Ash (76)

White laquer:

NCS S0300-N (31)

Handles:**03** Oak**06** Ash**30** White pigmented oak**10** White pigmented ash**86** Black stained ash**76** Dark stained ash**31** White (RAL 9016)

Description	Article number	Material	EUR		
FOR STORAGE WIDTH 800 MM:					
 <p>377 0 0 2 x 387</p>	Biblio sliding doors 1xA4-height. Fit on basic unit 800x420x430 mm (art 71310)	64 31xx 713481A White direct laminate 64 xxxx 713481A Veneer group 1 64 xxxx 713481A Veneer group 2 64 99xx 713481A Optional NCS	538 634 717 773		
	 <p>778 0 0 2 x 387</p>	Biblio sliding doors 2xA4-height. Fit on basic unit 1200x821x430 mm (art 72510)	64 31xx 723481A White direct laminate 64 xxxx 723481A Veneer group 1 64 xxxx 723481A Veneer group 2 64 99xx 723481A Optional NCS	557 654 736 793	
		 <p>1057 0 0 2 x 387</p>	Biblio sliding doors 3xA4-height. Fit on basic unit 800x1100x430 mm (art 73310)	64 31xx 733481A White direct laminate 64 xxxx 733481A Veneer group 1 64 xxxx 733481A Veneer group 2 64 99xx 733481A Optional NCS	576 672 755 812
			FOR STORAGE WIDTH 1200 MM:		
 <p>377 0 0 2 X 587</p>			Biblio sliding doors 1xA4-height. Fit on basic unit 1200x420x430 mm (art 71510)	64 31xx 715481A White direct laminate 64 xxxx 715481A Veneer group 1 64 xxxx 715481A Veneer group 2 64 99xx 715481A Optional NCS	544 640 723 780
	 <p>778 0 0 2 X 587</p>		Biblio sliding doors 2xA4-height. fit on basic unit 1200x821x430 mm (art 72510)	64 31xx 725481A White direct laminate 64 xxxx 725481A Veneer group 1 64 xxxx 725481A Veneer group 2 64 99xx 725481A Optional NCS	583 679 761 818
		 <p>1057 0 0 2 X 587</p>	Biblio sliding doors 3xA4-height. Fit on basic unit 1200x1100x430 mm (art 73510 och 73512)	64 31xx 735481A White direct laminate 64 xxxx 735481A Veneer group 1 64 xxxx 735481A Veneer group 2 64 99xx 735481A Optional NCS	608 704 787 844

Description	Article number	Material	EUR
FOR STORAGE WIDTH 1600 MM:			
 <p>377 2 X 791</p>	<p>Biblio sliding doors 1xA4-height. Fit on basic unit 1600x420x430 mm (art 71710)</p>	<p>64 31xx 717481A 64 xxxx 717481A 64 xxxx 717481A 64 99xx 717481A</p>	<p>White direct laminate 576 Veneer group 1 672 Veneer group 2 755 Optional NCS 812</p>
 <p>778 2 X 791</p>	<p>Biblio sliding doors 2xA4-height. Fit on basic unit 1600x821x430 mm (art 72710)</p>	<p>64 31xx 727481A 64 xxxx 727481A 64 xxxx 727481A 64 99xx 727481A</p>	<p>White direct laminate 621 Veneer group 1 791 Veneer group 2 874 Optional NCS 857</p>
 <p>1057 2 X 791</p>	<p>Biblio sliding doors 3xA4-height. Fit on basic unit 1600x1100x430 mm (art 73710 och 73712)</p>	<p>64 31xx 737481A 64 xxxx 737481A 64 xxxx 737481A 64 99xx 737481A</p>	<p>White direct laminate 669 Veneer group 1 826 Veneer group 2 909 Optional NCS 905</p>

Description	Article number	Material	EUR
-------------	----------------	----------	-----

Nomono Design: Fredrik Mattson

Nomono SLIDING DOORS



- Sliding doors in lacquered or veneered MDF
- Handles in lacquered steel sheet
- Fronts in optional NCS: delivery time 6 weeks.
- Including lock with 2 keys
- For additional product information please see www.horreds.se

Note! Price is for sliding doors only.

- Basic unit and base to be ordered separately.

Material:

Veneer group 1:

- Birch (05)
- Oak (03)
- Ash (06)

Veneer group 2:

- White pigmented Oak (30)
- White pigmented Ash (10)
- Black stained Ash (86)
- Dark stained Ash (76)

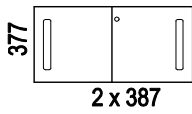
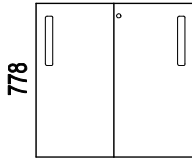
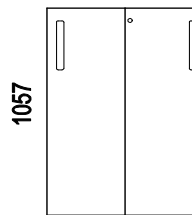
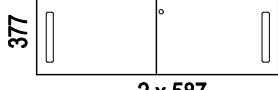
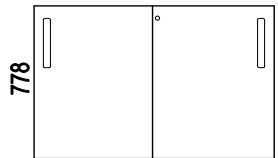
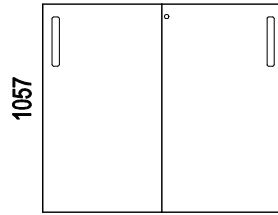
White laquer:

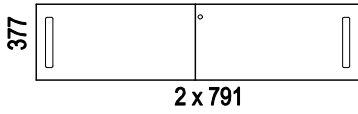
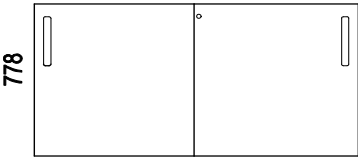
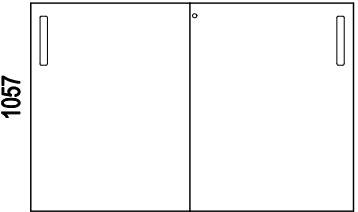
- NCS S0300-N (31)

Colour handles / Closest NCS

- 31** White S0300-N
- 37** Black S9000-N
- 32** Yellow S1070-Y
- 36** Green S2570-G30Y
- 33** Red S1580-Y80R
- 35** Turq.Blue S540-B30G
- 42** Orange S1080-Y50R
- xx** *Elmosoft Light Brown 54035
* additional cost € 70



Description	Article number	Material	EUR
FOR STORAGE WIDTH 800 MM:			
 <p>377 2 x 387</p>	Nomono sliding doors 1xA4-height. Fit on basic unit 800x420x430 mm (art 71310)	53 31xx 713381A White laquer	508
		53 xxxx 713381A Veneer group 1	603
		53 xxxx 713381A Veneer group 2	684
		53 99xx 713381A Optional NCS	740
 <p>778 2 x 387</p>	Nomono sliding doors 2xA4-height. Fit on basic unit 800x821x430 mm (art 72510)	53 31xx 723381A White laquer	528
		53 xxxx 723381A Veneer group 1	622
		53 xxxx 723381A Veneer group 2	703
		53 99xx 723381A Optional NCS	759
 <p>1057 2 x 387</p>	Nomono sliding doors 3xA4-height. Fit on basic unit 800x1100x430 mm (art 73310)	53 31xx 733381A White laquer	546
		53 xxxx 733381A Veneer group 1	641
		53 xxxx 733381A Veneer group 2	721
		53 99xx 733381A Optional NCS	778
FOR STORAGE WIDTH 1200 MM:			
 <p>377 2 x 587</p>	Nomono sliding doors 1xA4-height. Fit on basic unit 1200x420x430 mm (art 71510)	53 31xx 715381A White laquer	515
		53 xxxx 715381A Veneer group 1	609
		53 xxxx 715381A Veneer group 2	690
		53 99xx 715381A Optional NCS	746
 <p>778 2 x 587</p>	Nomono sliding doors 2xA4-height. fit on basic unit 1200x821x430 mm (art 72510)	53 31xx 725381A White laquer	553
		53 xxxx 725381A Veneer group 1	647
		53 xxxx 725381A Veneer group 2	728
		53 99xx 725381A Optional NCS	784
 <p>1057 2 x 587</p>	Nomono sliding doors 3xA4-height. Fit on basic unit 1200x1100x430 mm (art 73510 och 73512)	53 31xx 735381A White laquer	578
		53 xxxx 735381A Veneer group 1	672
		53 xxxx 735381A Veneer group 2	753
		53 99xx 735381A Optional NCS	809

Description	Article number	Material	EUR
FOR STORAGE WIDTH 1600 MM:			
 <p>377 2 x 791</p>	<p>Nomono sliding doors 1xA4-height. Fit on basic unit 1600x420x430 mm (art 71710)</p>	<p>53 31xx 717381A 53 xxxx 717381A 53 xxxx 717381A 53 99xx 717381A</p>	<p>White laquer 546 Veneer group 1 641 Veneer group 2 721 Optional NCS 778</p>
 <p>778 2 x 791</p>	<p>Nomono sliding doors 2xA4-height. Fit on basic unit 1600x821x430 mm (art 72710)</p>	<p>53 31xx 727381A 53 xxxx 727381A 53 xxxx 727381A 53 99xx 727381A</p>	<p>White laquer 591 Veneer group 1 757 Veneer group 2 838 Optional NCS 822</p>
 <p>1057 2 x 791</p>	<p>Nomono sliding doors 3xA4-height. Fit on basic unit 1600x1100x430 mm (art 73710 och 73712)</p>	<p>53 31xx 737381A 53 xxxx 737381A 53 xxxx 737381A 53 99xx 737381A</p>	<p>White laquer 638 Veneer group 1 791 Veneer group 2 872 Optional NCS 869</p>

Description	Article number	Material	EUR
-------------	----------------	----------	-----

VX



VX SLIDING DOORS

- Sliding doors in white direct laminated particle board or veneered MDF
- Steel handle
- Fronts in optional NCS (lacquered MDF): delivery time 6 weeks
- Including lock with 2 keys
- For additional product information please see www.horreds.se

Note! Price is for sliding doors only.

- Basic unit and base be ordered separately.

Material:

Veneer group 1:

Birch (05)

Oak (03)

Ash (06)

Veneer group 2:

White pigmented Oak (30)

White pigmented Ash (10)

Black stained Ash (86)

Dark stained Ash (76)

White direct laminate:

NCS S0300-N (31)

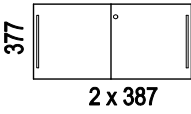
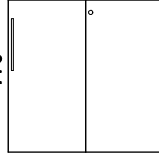
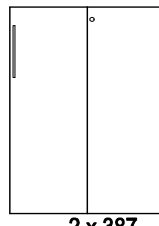
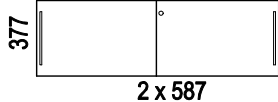
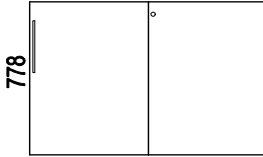
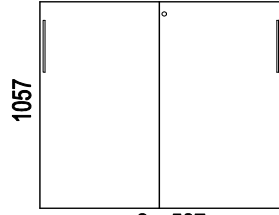
Colour handles

31 White

37 Black

17 Stainless steel look



Description	Article number	Material	EUR	
FOR STORAGE WIDTH 800 MM:				
 <p>377 2 x 387</p>	VX sliding doors 1xA4-height. Fit on basic unit 800x420x430 mm (art 71310)	34 31xx 713481A	White direct laminate	274
		34 xxxx 713481A	Veneer group 1	482
		34 xxxx 713481A	Veneer group 2	563
		34 99xx 713481A	Optional NCS	505
 <p>778 2 x 387</p>	VX sliding doors 2xA4-height. Fit on basic unit 800x821x430 mm (art 72510)	34 31xx 723481A	White direct laminate	289
		34 xxxx 723481A	Veneer group 1	500
		34 xxxx 723481A	Veneer group 2	581
		34 99xx 723481A	Optional NCS	521
 <p>1057 2 x 387</p>	VX sliding doors 3xA4-height. Fit on basic unit 800x1100x430 mm (art 73310)	34 31xx 733481A	White direct laminate	302
		34 xxxx 733481A	Veneer group 1	519
		34 xxxx 733481A	Veneer group 2	599
		34 99xx 733481A	Optional NCS	533
FOR STORAGE WIDTH 1200 MM:				
 <p>377 2 x 587</p>	VX sliding doors 1xA4-height. Fit on basic unit 1200x420x430 mm (art 71510)	34 31xx 715481A	White direct laminate	280
		34 xxxx 715481A	Veneer group 1	488
		34 xxxx 715481A	Veneer group 2	569
		34 99xx 715481A	Optional NCS	512
 <p>778 2 x 587</p>	VX sliding doors 2xA4-height. fit on basic unit 1200x821x430 mm (art 72510)	34 31xx 725481A	White direct laminate	305
		34 xxxx 725481A	Veneer group 1	524
		34 xxxx 725481A	Veneer group 2	605
		34 99xx 725481A	Optional NCS	535
 <p>1057 2 x 587</p>	VX sliding doors 3xA4-height. Fit on basic unit 1200x1100x430 mm (art 73510 och 73512)	34 31xx 735481A	White direct laminate	323
		34 xxxx 735481A	Veneer group 1	549
		34 xxxx 735481A	Veneer group 2	630
		34 99xx 735481A	Optional NCS	554

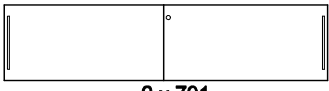
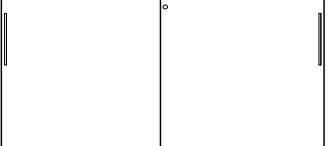
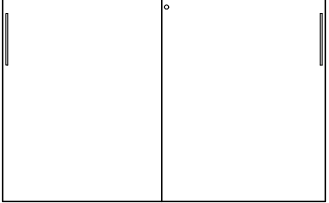
Description	Article number	Material	EUR
FOR STORAGE WIDTH 1600 MM: STORAGE			
 <p>377 2 x 791</p>	<p>VX sliding doors 1xA4-height. Fit on basic unit 1600x420x430 mm (art 71710)</p>	<p>34 31xx 717481A 34 717481A 34 717481A 34 717481A</p>	<p>White direct laminate 295 Veneer group 1 519 Veneer group 2 599 Optional NCS 527</p>
 <p>778 2 x 791</p>	<p>VX sliding doors 2xA4-height. Fit on basic unit 1600x821x430 mm (art 72710)</p>	<p>34 31xx 727481A 34 xxxx 727481A 34 xxxx 727481A 34 99xx 727481A</p>	<p>White direct laminate 323 Veneer group 1 630 Veneer group 2 711 Optional NCS 554</p>
 <p>1057 2 x 791</p>	<p>VX sliding doors 3xA4-height. Fit on basic unit 1600x1100x430 mm (art 73710 och 73712)</p>	<p>34 31xx 737481A 34 xxxx 737481A 34 xxxx 737481A 34 99xx 737481A</p>	<p>White direct laminate 359 Veneer group 1 664 Veneer group 2 744 Optional NCS 590</p>



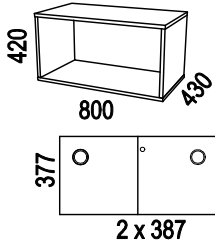
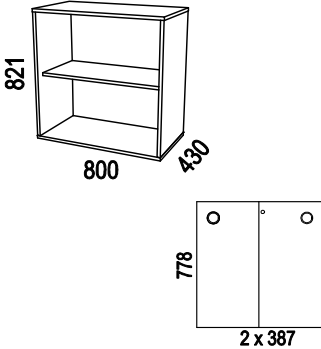
Illustration	Description	Article number	Material	EUR
Siglo Design: Henrik Schulz				
	<p>Siglo I STORAGE</p> <ul style="list-style-type: none"> • Basic unit in direct laminated alt. veneered particle board • Doors in direct laminate alt. veneered MDF • Back in melamine • Works also as a room divider • Stationary shelves • Clamping knobs as standard. Wooden base as option • For additional product information; please see www.horreds.se 	 MÖBELFAKTA		
<p><u>Material:</u></p> <p>Veneer group 1: Birch (05) Oak (03) Ash (06)</p> <p>Veneer group 2: Black stained Ash (86) Dark stained Ash (76) White pigmented Oak (30) White pigmented Ash (10)</p> <p>White direct laminate: Closest NCS: S0300-N</p>	<p><u>Handles standard:</u></p> <p>31 White plastic 37 Black plastic</p> <p><u>Handles optional:</u></p> <p>16 Brass 17 Stainless</p>			
<p>Options:</p> <ul style="list-style-type: none"> • Handles in brass or stainless steel: additional fee € 269. • Doors in optional NCS: additional fee € 249. Delivery time 6 weeks. 				
WIDTH 800 MM:			Unit / doors	
	Unit 800x420x430 mm (art 71310) including sliding doors (art 713081A) and clamping knobs (art 600004-19).	60 3131xx S1A1 60 31xxxx S1A1 60 31xxxx S1A1 60 xx31xx S1A1 60 xx31xx S1A1 60 xxxxxx S1A1 60 xxxxxx S1A1	White/white White/veneer gr 1 White/veneer gr 2 Veneer gr 1 / White Veneer gr 2 / White Veneer/veneer gr 1 Veneer/veneer gr 2	785 1 018 1 109 1 046 1 161 1 297 1 509
	Unit 800x821x430 mm (art 72310) including sliding doors (art 723081A) and clamping knobs (art 600004-19).	60 3131xx S1A2 60 31xxxx S1A2 60 31xxxx S1A2 60 xx31xx S1A2 60 xx31xx S1A2 60 xxxxxx S1A2 60 xxxxxx S1A2	White/white White/veneer gr 1 White/veneer gr 2 Veneer gr 1 / White Veneer gr 2 / White Veneer/veneer gr 1 Veneer/veneer gr 2	913 1 149 1 241 1 275 1 432 1 530 1 784

Illustration	Description	Article number	Material	EUR
<p>1100 800 430 1057 2 x 387</p>	Unit 800x1100x430 mm (art 73310) including sliding doors (art 733081A) and clamping knobs (art 600004-19).	60 3131xx S1A3	White/white	1 009
		60 31xxxx S1A3	White/veneer gr 1	1 253
		60 31xxxx S1A3	White/veneer gr 2	1 344
		60 xx31xx S1A3	Veneer gr 1 / White	1 623
		60 xx31xx S1A3	Veneer gr 2 / White	1 847
		60 xxxxxx S1A3	Veneer/veneer gr 1	1 885
		60 xxxxxx S1A3	Veneer/veneer gr 2	2 206
<p>100 800 430</p>	Add. fee for base 800x100x430 mm instead of clamping knobs	60 31 70310	White direct lam.	117
		60 xx 70310	Veneer group 1	129
		60 xx 70310	Veneer group 2	154
WIDTH 1200 MM:				
<p>420 1200 430 377 2 x 587</p>	Unit 1200x420x430 mm (art 71510) including sliding doors (art 715081A) and clamping knobs (art 600006-19).	60 3131xx S1B1	White/white	891
		60 31xxxx S1B1	White/veneer gr 1	1 124
		60 31xxxx S1B1	White/veneer gr 2	1 215
		60 xx31xx S1B1	Veneer gr 1 / White	1 280
		60 xx31xx S1B1	Veneer gr 2 / White	1 440
		60 xxxxxx S1B1	Veneer/veneer gr 1	1 531
		60 xxxxxx S1B1	Veneer/veneer gr 2	1 788
<p>821 1200 430 778 2 x 587</p>	Unit 1200x821x430 mm (art 72510) including sliding doors (art 725081A) and clamping knobs (art 600006-19).	60 3131xx S1B2	White/white	1 090
		60 31xxxx S1B2	White/veneer gr 1	1 337
		60 31xxxx S1B2	White/veneer gr 2	1 428
		60 xx31xx S1B2	Veneer gr 1 / White	1 604
		60 xx31xx S1B2	Veneer gr 2 / White	1 824
		60 xxxxxx S1B2	Veneer/veneer gr 1	1 870
		60 xxxxxx S1B2	Veneer/veneer gr 2	2 186
<p>1100 1200 430 1057 2 x 587</p>	Unit 1200x1100x430 mm (art 73510) including sliding doors (art 735081A) and clamping knobs (art 600006-19).	60 3131xx S1B3	White/white	1 111
		60 31xxxx S1B3	White/veneer gr 1	1 371
		60 31xxxx S1B3	White/veneer gr 2	1 462
		60 xx31xx S1B3	Veneer gr 1 / White	1 687
		60 xx31xx S1B3	Veneer gr 2 / White	1 919
		60 xxxxxx S1B3	Veneer/veneer gr 1	1 967
		60 xxxxxx S1B3	Veneer/veneer gr 2	2 296

Illustration	Description	Article number	Material	EUR
	Unit 1200x1100x430 mm with wardrobe (art 73512) including sliding doors (art 735081A) and clamping knobs (art 600006-19).	60 3131xx S1BG	White/white	1 510
		60 31xxxx S1BG	White/veneer gr 1	1 770
		60 31xxxx S1BG	White/veneer gr 2	1 861
		60 xx31xx S1BG	Veneer gr 1 / White	2 009
		60 xx31xx S1BG	Veneer gr 2 / White	2 306
		60 xxxxxx S1BG	Veneer/veneer gr 1	2 290
		60 xxxxxx S1BG	Veneer/veneer gr 2	2 684
	Add. fee for base 1200x100x430 mm instead of clamping knobs	60 31 70510	White direct lam.	127
		60 xx 70510	Veneer group 1	157
		60 xx 70510	Veneer group 2	189
WIDTH 1600 MM:				
	Unit 1600x420x430 mm (art 71710) including sliding doors (art 717081A) and clamping knobs (art 600006-19).	60 3131xx S1C1	White/white	1 014
		60 31xxxx S1C1	White/veneer gr 1	1 264
		60 31xxxx S1C1	White/veneer gr 2	1 355
		60 xx31xx S1C1	Veneer gr 1 / White	1 463
		60 xx31xx S1C1	Veneer gr 2 / White	1 656
		60 xxxxxx S1C1	Veneer/veneer gr 1	1 732
		60 xxxxxx S1C1	Veneer/veneer gr 2	2 023
	Unit 1600x821x430 mm (art 72710) including sliding doors (art 727081A) and clamping knobs (art 600006-19).	60 3131xx S1C2	White/white	1 246
		60 31xxxx S1C2	White/veneer gr 1	1 502
		60 31xxxx S1C2	White/veneer gr 2	1 593
		60 xx31xx S1C2	Veneer gr 1 / White	1 871
		60 xx31xx S1C2	Veneer gr 2 / White	2 067
		60 xxxxxx S1C2	Veneer/veneer gr 1	2 147
		60 xxxxxx S1C2	Veneer/veneer gr 2	2 441

Illustration	Description	Article number	Material	EUR
<p>Unit 1600x1100x430 mm (art 73710) including sliding doors (art 737081A) and clamping knobs (art 600006-19).</p>	<p>Unit 1600x1100x430 mm (art 73710) including sliding doors (art 737081A) and clamping knobs (art 600006-19).</p>	60 3131xx S1C3	White/white	1 373
		60 31xxxx S1C3	White/veneer gr 1	1 715
		60 31xxxx S1C3	White/veneer gr 2	1 806
		60 xx31xx S1C3	Veneer gr 1 / White	2 040
		60 xx31xx S1C3	Veneer gr 2 / White	2 332
		60 xxxxxx S1C3	Veneer/veneer gr 1	2 407
		60 xxxxxx S1C3	Veneer/veneer gr 2	2 797
<p>Unit 1600x1100x430 mm with wardrobe (art 73712) including sliding doors (art 737081A) and clamping knobs (art 600006).</p>	<p>Unit 1600x1100x430 mm with wardrobe (art 73712) including sliding doors (art 737081A) and clamping knobs (art 600006).</p>	60 3131xx S1CG	White/white	1 615
		60 31xxxx S1CG	White/veneer gr 1	1 956
		60 31xxxx S1CG	White/veneer gr 2	2 048
		60 xx31xx S1CG	Veneer gr 1 / White	2 315
		60 xx31xx S1CG	Veneer gr 2 / White	2 780
		60 xxxxxx S1CG	Veneer/veneer gr 1	2 780
		60 xxxxxx S1CG	Veneer/veneer gr 2	3 245
<p>Add. fee for base 1600x100x430 mm instead of clamping knobs</p>	<p>Add. fee for base 1600x100x430 mm instead of clamping knobs</p>	60 31 70710	White direct lam.	134
		60 xx 70710	Veneer group 1	201
		60 xx 70710	Veneer group 2	243



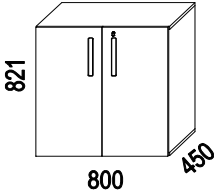
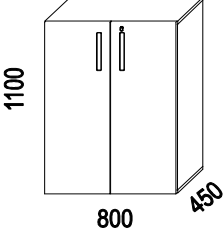
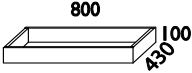
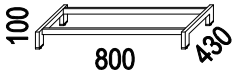
Illustration	Description	Article number	Material	EUR
<p>Nomono Design: Fredrik Mattson</p>				
	<p>Nomono WITH HINGED DOORS</p> <ul style="list-style-type: none"> • Basic unit in direct laminated or veneered particleboard. • Hinged doors in lacquered or veneered MDF. Opening 110° • Including lock with 2 keys • Back in melamine • Stationary shelves • Fronts in optiona NCS: delivery time 6 weeks • Base not included, order separately • For additional product information please see www.horred.se <p>Material:</p> <p>Veneer group 1: Birch (05) Oak (03) Ash (06)</p> <p>Veneer group 2: White pigmented Oak (30) White pigmented Ash (10) Black stained Ash (86) Black stained Ash (76)</p> <p>White direct laminate and laquer: NCS S0300-N (31)</p>		 <p>Colour handles / Closest NCS</p> <p>31 White S0300-N 37 Black S9000-N 32 Yellow S1070-Y 36 Green S2570-G30Y 33 Red S1580-Y80R 35 Turq.Blue S540-B30G 42 Orange S1080-Y50R xx * Elmosoft light brown 54035 * additional fee € 70.</p>	
	<p>Storage 800x821x450 mm. 2 A4-height with hinged doors.</p> <p><i>Upcharge for doors in optional NCS</i></p>	<p>53 31xx 72340 53 xxxx 72340 53 xxxx 72340</p>	<p>White Veneer group 1 Veneer group 1</p>	<p>1 039 1 352 1 591 141</p>
	<p>Storage 800x1100x450 mm. 3 A4-height with hinged doors.</p> <p><i>Upcharge for doors in optional NCS</i></p>	<p>53 31xx 73340 53 xxxx 73340 53 xxxx 73340</p>	<p>White Veneer group 1 Veneer group 1</p>	<p>1 157 1 513 1 744 141</p>
	<p>Base 800x100x430 mm</p>	<p>57 31 70310 57 xxxx 70310 57 xxxx 70310</p>	<p>White Veneer group 1 Veneer group 1</p>	<p>119 137 164</p>
	<p>Leg base 800x100x430 mm, steel.</p>	<p>57 31 70330 57 37 70330</p>	<p>White Black</p>	<p>213 213</p>



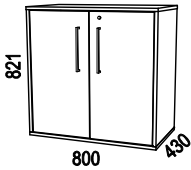
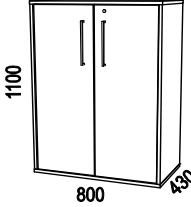
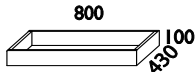
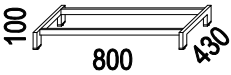




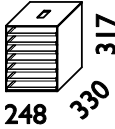



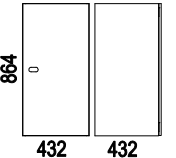
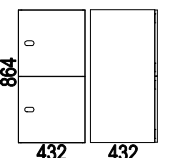
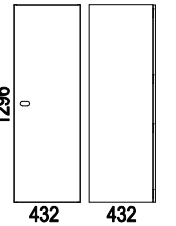
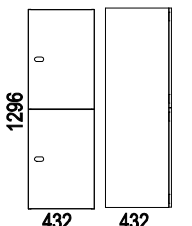
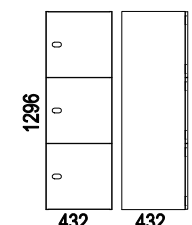
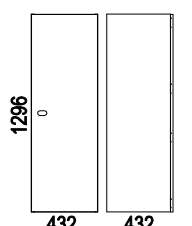
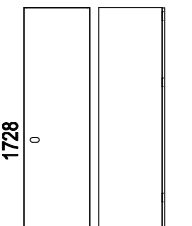
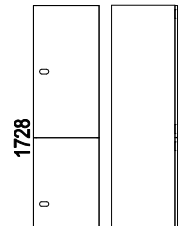
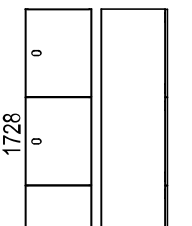
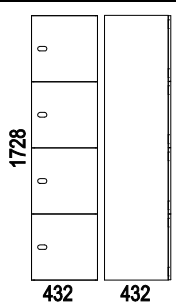
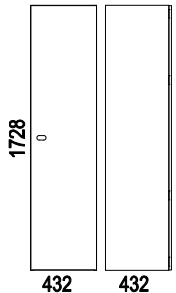
Illustration	Description	Article number	Material	EUR
VX				
VX WITH HINGED DOORS				
	<ul style="list-style-type: none"> • Basic unit in direct laminated or veneered particleboard. • Hinged doors in direct laminated particle board or veneered MDF. • Including lock with 2 keys. • Back in melamine • Stationary shelves • Base not included, order separately • For more product information; please see www.horreds.se 			
	<p>Material:</p> <p>Veneer group 1: birch (05), oak (03), ash (06)</p> <p>Veneer group 2: black ash (86), dark ash (76), white oak (30), white ash (10)</p> <p>White direct laminatet: closest NCS S0300-N (31)</p>	<p>Colour handles</p> <p>31 White</p> <p>37 Black</p> <p>17 Stainless steel look</p>		
	<p>Storage 800x821x430 mm.</p> <p>2 A4-height with hinged doors.</p> <p><i>Upcharge for doors in optional NCS</i></p>	<p>34 31xx 72330</p> <p>34 xxxx 72330</p> <p>34 xxxx 72330</p>	<p>White direct laminate</p> <p>Veneer group 1</p> <p>Veneer group 2</p>	<p>705</p> <p>1 236</p> <p>1 405</p> <p>231</p>
	<p>Storage 800x1100x430 mm.</p> <p>3 A4-height with hinged doors.</p> <p><i>Upcharge for doors in optional NCS</i></p>	<p>34 31xx 73330</p> <p>34 xxxx 73330</p> <p>34 xxxx 73330</p>	<p>White direct laminate</p> <p>Veneer group 1</p> <p>Veneer group 2</p>	<p>754</p> <p>1 327</p> <p>1 558</p> <p>231</p>
	<p>Base 800x100x430 mm</p>	<p>57 31 70310</p> <p>57 xx 70310</p> <p>57 xx 70310</p>	<p>White direct laminate</p> <p>Veneer group 1</p> <p>Veneer group 2</p>	<p>119</p> <p>137</p> <p>164</p>
	<p>Leg base 800x100x430 mm, steel.</p>	<p>57 31 70330</p> <p>57 37 70330</p>	<p>White</p> <p>Black</p>	<p>213</p> <p>213</p>
	<p>Castors. Height 100 mm.</p> <p>For 800 mm wide storage (4 castors of which 2 lockable).</p>	<p>39 08 28</p>	<p>Grey/zink</p>	<p>69</p>
	<p>Base plate with small adjustable feet</p> <p>798x35x427 mm</p>	<p>57 31 70381</p> <p>57 xx 70381</p> <p>57 xx 70381</p>	<p>White direct laminate</p> <p>Veneer group 1</p> <p>Veneer group 2</p>	<p>63</p> <p>96</p> <p>96</p>
	<p>Clamping knobs (4 pieces)</p>	<p>57 00 04</p>		<p>23</p>

Illustration	Description	Article number	Material	EUR
<p>ACCESSORIES TO STORAGE WITH DEPTH 43 CM</p> <ul style="list-style-type: none"> • Fronts in optional NCS: delivery time 6 weeks • For more product information, see www.horreds.se 				
	<p>Insert in direct laminate with fronts in lacquer. 3 drawers. The top drawer is lockable and incl a plastic pen drawer.</p> <p><i>NB: does not fit VX width 80 cm with sliding doors.</i></p>	<p>57 31 076</p> <p>57 3199 076</p>	<p>White/white fronts</p> <p>White/opt.NCS fronts</p>	<p>354</p> <p>462</p>
	<p>Hanging file drawer, assembled on expansion racks.</p> <p>Fits in all units with slidings doors and in Nomono with hinged doors.</p>	<p>57 31 03160</p>	<p>White</p>	<p>177</p>
	<p>C4-letter stack. Including 7 letter trays.</p>	<p>50 047 134</p>	<p>Black</p>	<p>70</p>

BIBLIO	Design: Anderssen & Voll	
<p>Biblio Personal Storage</p> <ul style="list-style-type: none"> • Basic unit in white direct laminated chipboard • Depth 432 mm is standard, 500 mm optional • Hinged doors (soft close) in veneer, white lacquer and optional NCS • Handle grip with underlying plate in veneer • Electronical locks: Mifare 13,56 MHz, battery incl. • Battery replacement is recom. at 2-year intervals. • User card Mifare not included, order separately • Network-basd locks against quotation • Labeling of cabinets against quotation • Adjustable shelves are ordered separately • Bases are ordered separately • Side covers and tops in veneer are optional • Should be anchored to the wall due to tipping risk • For more product information, see www.horreds.se 		 
<p><u>Basic units:</u> White direct laminate, closest NCS S0300-N (31). <u>Doors white lacquer:</u> closest NCS S0300-N (31). <u>Doors coloured lacquer:</u> Optional NCS (99). <u>Doors veneer group 1:</u> Oak (03), Ash (06). <u>Doors veneer group 2:</u> White oak (30), White Ash (10), Black Ash (86) Dark Ash (76), Stained ash Burgundy (C8), Stained ash Conifer (D3), Stained ash Smokey Blue (D4).</p>		

		<u>Door model</u>	<u>Article number</u>	<u>White</u>	<u>NCS</u>	<u>Veneer 1</u>	<u>Veneer 2</u>
	Storage white dir.lam. 432x432x432 mm incl 1 door <i>Upcharge for depth 500 mm</i>	Without lock	64 xx xx 111H/V	344	386	375	397
		Electronic lock	64 xx xx 111AH/V	589	631	620	641
		Code lock	64 xx xx 111BH/V	417	459	449	470
		Cylinder lock	64 xx xx 111CH/V	391	433	423	444
				<i>211xH/V</i>	<i>51</i>	<i>51</i>	<i>51</i>
	Storage white dir.lam. 432x864x432 mm incl 1 door Shelves not included, order separately <i>Upcharge for depth 500 mm</i>	Without lock	64 xx xx 121H/V	386	449	433	462
		Electronic lock	64 xx xx 121AH/V	631	694	679	708
		Code lock	64 xx xx 121BH/V	459	523	507	536
		Cylinder lock	64 xx xx 121CH/V	433	497	481	510
				<i>221xH/V</i>	<i>61</i>	<i>61</i>	<i>61</i>
	Storage white dir.lam. 432x864x432 mm incl 2 doors and 1 stationary shelf. <i>Upcharge for depth 500 mm</i>	Without lock	64 xx xx 122H/V	533	617	586	628
		Electronic lock	64 xx xx 122AH/V	1 023	1 108	1 076	1 118
		Code lock	64 xx xx 122BH/V	680	765	733	775
		Cylinder lock	64 xx xx 122CH/V	628	712	680	722
				<i>222xH/V</i>	<i>61</i>	<i>61</i>	<i>61</i>
	Storage white dir.lam. 432x1296x432 mm incl 1 door Shelves not included, order separately <i>Upcharge for depth 500 mm</i>	Without lock	64 xx xx 131H/V	502	586	591	628
		Electronic lock	64 xx xx 131AH/V	747	831	836	873
		Code lock	64 xx xx 131BH/V	575	660	665	701
		Cylinder lock	64 xx xx 131CH/V	549	633	638	676
				<i>231xH/V</i>	<i>73</i>	<i>73</i>	<i>73</i>

		<u>Door model</u>	<u>Article number</u>	<u>White</u>	<u>NCS</u>	<u>Veneer 1</u>	<u>Veneer 2</u>
	Storage white dir.lam. 432x1296x432 mm incl 2 doors Extra shelves to be ordered separately <i>Upcharge for depth 500 mm</i>	Without lock	64 xx xx 132H/V	591	717	691	749
		Electronic lock	64 xx xx 132AH/V	1 081	1 208	1 181	1 239
		Code lock	64 xx xx 132BH/V	738	865	838	896
		Cylinder lock	64 xx xx 132CH/V	686	812	786	844
				<i>232xH/V</i>	73	73	73
	Storage white dir.lam. 432x1296x432 mm incl 3 doors and 2 stationary shelves. <i>Upcharge for depth 500 mm</i>	Without lock	64 xx xx 133H/V	722	849	796	859
		Electronic lock	64 xx xx 133AH/V	1 458	1 584	1 532	1 595
		Code lock	64 xx xx 133BH/V	944	1 103	1 017	1 080
		Cylinder lock	64 xx xx 133CH/V	865	991	938	1 001
				<i>233xH/V</i>	73	73	73
	Wardrobe white dir.lam. 432x1296x432 mm incl 1 door and anchor hook. Incl 2 removable shelves. <i>Upcharge for depth 500 mm</i>	Without lock	64 xx xx 131V/HG	623	733	707	744
		Electronic lock	64 xx xx 131AH/VG	868	978	952	989
		Code lock	64 xx xx 131BH/VG	696	807	780	817
		Cylinder lock	64 xx xx 131CH/VG	670	781	754	791
				<i>231xH/VG</i>	73	73	73
	Storage white dir.lam. 432x1728x432 mm incl 1 door and 1 stationary shelf, Extra shelves to be separately <i>Upcharge for depth 500 mm</i>	Without lock	64 xx xx 141H/V	617	728	696	738
		Electronic lock	64 xx xx 141AH/V	863	973	941	983
		Code lock	64 xx xx 141BH/V	691	801	770	812
		Cylinder lock	64 xx xx 141CH/V	665	775	744	786
				<i>241xH/V</i>	86	86	86
	Storage white dir.lam. 432x1728x432 mm incl 2 doors Shelves not included, order separately <i>Upcharge for depth 500 mm</i>	Without lock	64 xx xx 142H/V	675	801	754	812
		Electronic lock	64 xx xx 142AH/V	1 165	1 292	1 244	1 302
		Code lock	64 xx xx 142BH/V	823	949	901	959
		Cylinder lock	64 xx xx 142CH/V	770	896	849	907
				<i>242xH/V</i>	86	86	86
	Storage white dir.lam. 432x1728x432 mm incl 3 doors and 2 stationary shelves. <i>Upcharge for depth 500 mm</i>	Without lock	64 xx xx 143H/V	877	1 045	972	1 056
		Electronic lock	64 xx xx 143AH/V	1 709	1 878	1 804	1 888
		Code lock	64 xx xx 143BH/V	1 142	1 310	1 236	1 320
		Cylinder lock	64 xx xx 143CH/V	1 060	1 229	1 155	1 239
				<i>243xH/V</i>	86	86	86



		<u>Door model</u>	<u>Article number</u>	<u>White</u>	<u>NCS</u>	<u>Veneer 1</u>	<u>Veneer 2</u>
	Storage white dir.lam. 432x1728x432 mm incl 4 doors and 3 stationary shelves. <i>Upcharge for depth 500 mm</i>	Without lock	64 xx xx 144H/V	922	1 091	1 017	1 101
		Electronic lock	64 xx xx 144AH/V	1 903	2 071	1 997	2 082
		Code lock	64 xx xx 144BH/V	1 217	1 385	1 312	1 396
		Cylinder lock	64 xx xx 144CH/V	1 112	1 280	1 206	1 290
			<i>244xH/V</i>	86	86	86	86
	Wardrobe white dir.lam. 432x1728x432 mm incl 1 dor and anchor hook. Incl 2 removable shelves. <i>Upcharge for depth 500 mm</i>	Without lock	64 xx xx 141H/VG	717	828	796	838
		Electronic lock	64 xx xx 141AH/VG	962	1 073	1 041	1 083
		Code lock	64 xx xx 141BH/VG	791	901	870	912
		Cylinder lock	64 xx xx 141CH/VG	765	875	844	886
			<i>241xH/VG</i>	81	81	81	81

Bases, shelves and accessories: see page 81-83
Side and top covers: see page 84

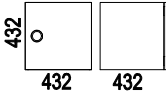
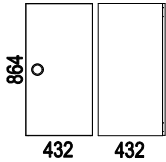
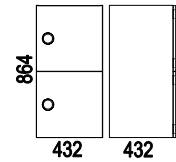
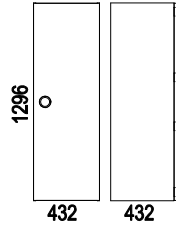
SIGLO Design: Henrik Schulz

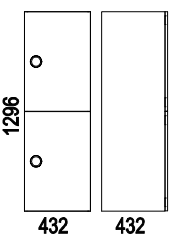
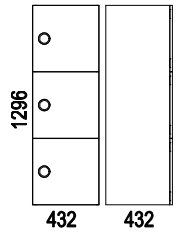
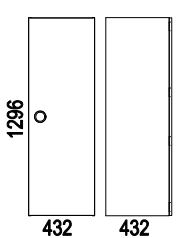
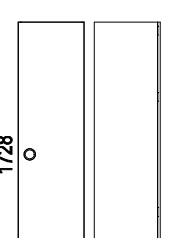
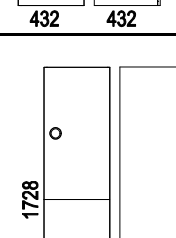
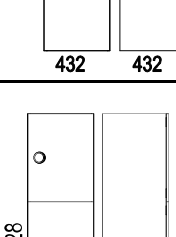
Siglo Personal Storage

- Basic unit in white direct laminated chipboard
- Depth 432 mm is standard, 500 mm optional.
- Hinged doors (soft close) in veneer, white lacquer and optional NCS
- Round recess for handle, with ring and plate in white (31) or black (37) plastic as standard
- Optional: handle in brass (16) & stainless steel (17)
- Electronical locks: Mifare 13,56 MHz, battery incl.
- Battery replacement is recom. at 2-year intervals.
- User card Mifare not included, order separately
- Network-based locks against quotation
- Labeling of cabinets against quotation
- Adjustable shelves are ordered separately
- Bases are ordered separately
- Side covers and tops in veneer are optional
- Should be anchored to the wall due to tipping risk
- For more product information, see www.horreds.se



Basic units: White direct laminate, closest NCS S0300-N (31).
Doors white direct laminate: closest NCS S0300-N (31).
Doors coloured lacquer: Optional NCS (99).
Doors veneer group 1: Oak (03), Ash (06).
Doors veneer group 2: White oak (30), White Ash (10), Black Ash (86) Dark Ash (76), Stained ash Burgundy (C8), Stained ash Conifer (D3), Stained ash Smokey Blue (D4).


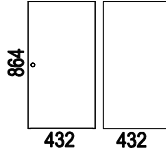
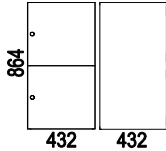
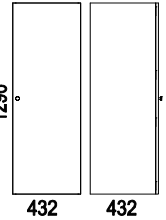
		Door model	Article number	White	NCS	Veneer 1	Veneer 2
	Storage white dir.lam. 432x432x432 mm incl 1 door	Without lock	60 xx xx 111H/V	316	386	362	386
		Electronic lock	60 xx xx 111AH/V	601	671	648	671
		Code lock	60 xx xx 111BH/V	398	467	444	467
		Cylinder lock	60 xx xx 111CH/V	369	438	415	438
	<i>Upcharge for handles in brass or stainless</i> <i>Upcharge for depth 500 mm</i>			211xH/V	135 51	135 51	135 51
	Storage white dir.lam. 432x864x432 mm incl 1 door Shelves not included, order separately	Without lock	60 xx xx 121H/V	339	433	421	453
		Electronic lock	60 xx xx 121AH/V	625	718	706	738
		Code lock	60 xx xx 121BH/V	421	514	502	534
		Cylinder lock	60 xx xx 121CH/V	392	485	473	505
	<i>Upcharge for handles in brass or stainless</i> <i>Upcharge for depth 500 mm</i>			221xH/V	135 61	135 61	135 61
	Storage white dir.lam. 432x864x432 mm incl 2 doors and 1 stationary shelf.	Without lock	60 xx xx 122H/V	456	595	549	595
		Electronic lock	60 xx xx 122AH/V	1 026	1 166	1 120	1 166
		Code lock	60 xx xx 122BH/V	618	758	712	758
		Cylinder lock	60 xx xx 122CH/V	560	700	654	700
	<i>Upcharge for handles in brass or stainless ste</i> <i>Upcharge for depth 500 mm</i>			222xH/V	270 61	270 61	270 61
	Storage white dir.lam. 432x1296x432 mm incl 1 door Shelves not included, order separately	Without lock	60 xx xx 131H/V	456	572	560	601
		Electronic lock	60 xx xx 131AH/V	741	857	846	887
		Code lock	60 xx xx 131BH/V	537	654	642	682
		Cylinder lock	60 xx xx 131CH/V	508	624	613	654
	<i>Upcharge for handles in brass or stainless ste</i> <i>Upcharge for depth 500 mm</i>			231xH/V	135 73	135 73	135 73

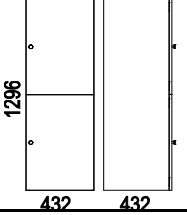
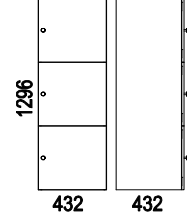
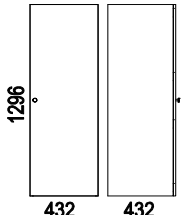
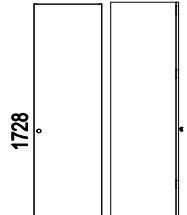
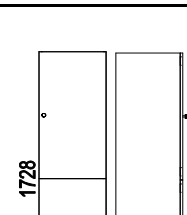
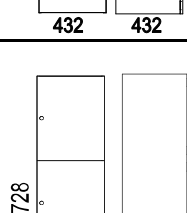
		<u>Door model</u>	<u>Article number</u>	<u>White</u>	<u>NCS</u>	<u>Veneer 1</u>	<u>Veneer 2</u>	
	Storage white dir.lam. 432x1296x432 mm incl 2 doors. Extra shelves to be ordered separately.	Without lock Electronic lock Code lock Cylinder lock	60 xx xx 132H/V 60 xx xx 132AH/V 60 xx xx 132BH/V 60 xx xx 132CH/V	496 1 067 659 601	682 1 253 845 787	654 1 224 816 758	717 1 288 880 822	
	<i>Upcharge for handles in brass or stainless steel</i>			270	270	270	270	
	<i>Upcharge for depth 500 mm</i>		232xH/V	73	73	73	73	
	Storage white dir.lam. 432x1296x432 mm incl 3 doors and 2 stationary shelves.	Without lock Electronic lock Code lock Cylinder lock	60 xx xx 133H/V 60 xx xx 133AH/V 60 xx xx 133BH/V 60 xx xx 133CH/V	607 1 463 851 764	816 1 672 1 060 973	735 1 591 979 892	804 1 661 1 049 961	
	<i>Upcharge for handles in brass or stainless steel</i>			405	405	405	405	
	<i>Tillägg för djup 500 mm</i>		233xH/V	73	73	73	73	
	Wardrobe white dir.lam. 432x1296x432 mm incl 1 door and anchor hook. Incl 2 removable shelves.	Ej låsbart Elektr.lås Kodlås Cylinderlås	60 xx xx 131H/VG 60 xx xx 131AH/VG 60 xx xx 131BH/VG 60 xx xx 131CH/VG	589 874 670 641	705 990 786 757	682 968 764 735	723 1 009 804 775	
	<i>Upcharge for handles in brass or stainless steel</i>			135	135	135	135	
	<i>Upcharge for depth 500 mm</i>		231xH/VG	73	73	73	73	
	Storage white dir.lam. 432x1728x432 mm incl 1 door and 1 stationary shelf. Extra shelves to be ordered sep.	Without lock Electronic lock Code lock Cylinder lock	60 xx xx 141H/V 60 xx xx 141AH/V 60 xx xx 141BH/V 60 xx xx 141CH/V	549 834 630 601	694 979 775 746	676 962 758 729	723 1 009 804 775	
	<i>Upcharge for handles in brass or stainless steel</i>			135	135	135	135	
	<i>Upcharge for depth 500 mm</i>		241xH/V	86	86	86	86	
	Storage white dir.lam. 432x1728x432 mm incl 2 doors Shelves not included, order separately	Without lock Electronic lock Code lock Cylinder lock	60 xx xx 142H/V 60 xx xx 142AH/V 60 xx xx 142BH/V 60 xx xx 142CH/V	566 1 137 729 671	752 1 323 915 857	717 1 288 880 822	781 1 352 944 886	
	<i>Upcharge for handles in brass or stainless steel</i>			270	270	270	270	
	<i>Upcharge for depth 500 mm</i>		242xH/V	86	86	86	86	
	Storage white dir.lam. 432x1728x432 mm incl 3 doors and 2 stationary shelves.	Without lock Electronic lock Code lock Cylinder lock	60 xx xx 143H/V 60 xx xx 143AH/V 60 xx xx 143BH/V 60 xx xx 143CH/V	724 1 710 1 020 927	1 003 1 989 1 299 1 206	893 1 878 1 188 1 096	985 1 971 1 282 1 189	
	<i>Upcharge for handles in brass or stainless steel</i>			406	406	406	406	
	<i>Upcharge for depth 500 mm</i>		243xH/V	86	86	86	86	

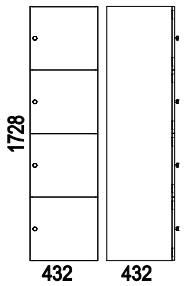
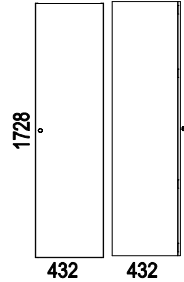
		<u>Door model</u>	<u>Article number</u>	<u>White</u>	<u>NCS</u>	<u>Veneer 1</u>	<u>Veneer 2</u>
	Storage white dir.lam.	Without lock	60 xx xx 144H/V	769	1 049	938	1 031
	432x1728x432 mm	Electronic lock	60 xx xx 144AH/V	1 911	2 190	2 079	2 173
	incl 4 doors and 3	Code lock	60 xx xx 144BH/V	1 095	1 374	1 264	1 357
	stationary shelves.	Cylinder lock	60 xx xx 144CH/V	979	1 258	1 148	1 240
	<i>Upcharge for handles in brass or stainless steel</i>			540	540	540	540
	<i>Upcharge for depth 500 mm</i>		244xH/V	86	86	86	86
	Wardrobe white dir.lam.	Without lock	60 xx xx 141H/VG	665	810	793	839
	432x1728x432 mm	Electronic lock	60 xx xx 141AH/VG	950	1 096	1 078	1 125
	incl 1 dor and anchor	Code lock	60 xx xx 141BH/VG	746	892	874	921
	hook. Incl 2 removable	Cylinder lock	60 xx xx 141CH/VG	717	863	845	892
	shelves.						
	<i>Upcharge for handles in brass or stainless steel</i>			135	135	135	135
	<i>Upcharge for depth 500 mm</i>		241xH/VG	86	86	86	86

Bases, shelves and accessories: see page 81-83
Side and top covers: see page 84

TETRIS	Design: Front Design	
<p>Tetris Personal Storage</p> <ul style="list-style-type: none"> • Basic unit in white direct laminated chipboard • Depth 432 mm is standard, 500 mm optional. • Hinged doors (soft close) in veneer, white lacquer and optional NCS • Handle knob in stainless steel (ø 25 mm) is standard. • Option: knob in slotted brass or copper (diameter 34 mm) • Electronical locks: Mifare 13,56 MHz, battery incl. • Battery replacement is recom. at 2-year intervals. • User card Mifare not included, order separately • Network-based locks against quotation • Labeling of cabinets against quotation • Adjustable shelves are ordered separately • Bases are ordered separately • Side covers and tops in veneer are optional • Should be anchored to the wall due to tipping risk • For more product information, see www.horreds.se 		
		
<p><u>Basic units:</u> White direct laminate, closest NCS S0300-N (31). <u>Doors white lacquer:</u> closest NCS S0300-N (31). <u>Doors coloured lacquer:</u> Optional NCS (99). <u>Doors veneer group 1:</u> Oak (03), Ash (06). <u>Doors veneer group 2:</u> White oak (30), White Ash (10), Black Ash (86) Dark Ash (76), Stained ash Burgundy (C8), Stained ash Conifer (D3), Stained ash Smokey Blue (D4).</p>		

		<u>Door model</u>	<u>Article number</u>	<u>White</u>	<u>NCS</u>	<u>Veneer 1</u>	<u>Veneer 2</u>
	Storage white dir.lam. 432x432x432 mm incl 1 door	Without lock Electronic lock Code lock Cylinder lock	75 xx 111H/V 75 xx 111AH/V 75 xx 111BH/V 75 xx 111CH/V	296 541 370 344	339 584 412 386	318 563 391 365	339 584 412 386
	<i>Upcharge for knob in brass or copper</i> <i>Upcharge for depth 500 mm</i>		211xH/V	67 51	67 51	67 51	67 51
	Storage white dir.lam. 432x862x432 mm incl 1 door Shelves not included, order separately	Without lock Electronic lock Code lock Cylinder lock	75 xx 121H/V 75 xx 121AH/V 75 xx 121BH/V 75 xx 121CH/V	323 568 397 370	386 631 459 433	370 615 444 417	399 644 473 447
	<i>Upcharge for knob in brass or copper</i> <i>Upcharge for depth 500 mm</i>		221xH/V	67 61	67 61	67 61	67 61
	Storage white dir.lam. 432x864x432 mm incl 2 doors and 1 stationary shelf.	Without lock Electronic lock Code lock Cylinder lock	75 xx 122H/V 75 xx 122AH/V 75 xx 122BH/V 75 xx 122CH/V	444 934 591 539	528 1 018 675 623	491 981 638 586	533 1 023 680 628
	<i>Upcharge for knob in brass or copper</i> <i>Upcharge for depth 500 mm</i>		222xH/V	133 61	133 61	133 61	133 61
	Storage white dir.lam. 432x1296x432 mm incl 1 door Shelves not included, order separately	Without lock Electronic lock Code lock Cylinder lock	75 xx 131H/V 75 xx 131AH/V 75 xx 131BH/V 75 xx 131CH/V	439 683 512 486	523 768 596 570	502 747 575 549	539 784 612 586
	<i>Upcharge for knob in brass or copper</i> <i>Upcharge for depth 500 mm</i>		231xH/V	67 73	67 73	67 73	67 73

		<u>Door model</u>	<u>Article number</u>	<u>White</u>	<u>NCS</u>	<u>Veneer 1</u>	<u>Veneer 2</u>
	Storage white dir.lam. 432x1296x432 mm incl 2 doors. Extra shelves to be ordered separately. <i>Upcharge for knob in brass or copper</i> <i>Upcharge for depth 500 mm</i>	Without lock	75 xx 132H/V	480	607	586	644
		Electronic lock	75 xx 132AH/V	971	1 097	1 076	1 134
		Code lock	75 xx 132BH/V	628	754	733	791
		Cylinder lock	75 xx 132CH/V	575	701	680	738
				232xH/V	73	73	73
	Storage white dir.lam. 432x1296x432 mm incl 3 doors and 2 stationary shelves. <i>Upcharge for knob in brass or copper</i> <i>Upcharge for depth 500 mm</i>	Without lock	75 xx 133H/V	591	717	660	722
		Electronic lock	75 xx 133AH/V	1 326	1 452	1 395	1 458
		Code lock	75 xx 133BH/V	812	938	880	944
		Cylinder lock	75 xx 133CH/V	733	859	801	865
				233xH/V	73	73	73
	Wardrobe white dir.lam. 432x1296x432 mm incl 1 door and anchor hook. Incl 2 removable shelves. <i>Upcharge for knob in brass or copper</i> <i>Upcharge for depth 500 mm</i>	Without lock	75 xx 131H/VG	560	670	623	660
		Electronic lock	75 xx 131AH/VG	805	915	868	905
		Code lock	75 xx 131BH/VG	633	744	696	733
		Cylinder lock	75 xx 131CH/VG	607	717	670	707
				231xH/VG	67	67	67
				73	73	73	73
	Storage white dir.lam. 432x1728x432 mm incl 1 door and 1 stationary shelf. Extra shelves to be oreded separately. <i>Upcharge for knob in brass or copper</i> <i>Upcharge for depth 500 mm</i>	Without lock	75 xx 141H/V	533	644	607	649
		Electronic lock	75 xx 141AH/V	778	889	852	894
		Code lock	75 xx 141BH/V	607	717	680	722
		Cylinder lock	75 xx 141CH/V	580	691	654	696
				241xH/V	67	67	67
				86	86	86	86
	Storage white dir.lam. 432x1728x432 mm incl 2 doors Shleves not included, order separately <i>Upcharge for knob in brass or copper</i> <i>Upcharge for depth 500 mm</i>	Without lock	75 xx 142H/V	549	675	644	701
		Electronic lock	75 xx 142AH/V	1 039	1 165	1 134	1 192
		Code lock	75 xx 142BH/V	696	823	791	849
		Cylinder lock	75 xx 142CH/V	644	770	738	796
				242xH/V	133	133	133
				86	86	86	86
	Storage white dir.lam. 432x1728x432 mm incl 3 doors and 2 stationary shelves. <i>Upcharge for knob in brass or copper</i> <i>Upcharge for depth 500 mm</i>	Without lock	75 xx 143H/V	704	872	793	877
		Electronic lock	75 xx 143AH/V	1 536	1 704	1 625	1 709
		Code lock	75 xx 143BH/V	968	1 137	1 058	1 142
		Cylinder lock	75 xx 143CH/V	886	1 055	976	1 060
				243xH/V	199	199	199
				86	86	86	86

		<u>Door model</u>	<u>Article number</u>	<u>White</u>	<u>NCS</u>	<u>Veneer 1</u>	<u>Veneer 2</u>
	Storage white dir.lam. 432x1728x432 mm incl 4 doors and 3 stationary shelves. <i>Upcharge for knob in brass or copper</i> <i>Upcharge for depth 500 mm</i>	Without lock	75 xx 144H/V	749	917	838	922
		Electronic lock	75 xx 144AH/V	1 729	1 898	1 819	1 903
		Code lock	75 xx 144BH/V	1 043	1 212	1 133	1 217
		Cylinder lock	75 xx 144CH/V	938	1 107	1 027	1 112
			<i>244xH/V</i>	266	266	266	266
			<i>86</i>	<i>86</i>	<i>86</i>	<i>86</i>	
	Wardrobe white dir.lam. 432x1728x432 mm incl 1 dor and anchor hook. Incl 2 removable shelves. <i>Upcharge for knob in brass or copper</i> <i>Upcharge for depth 500 mm</i>	Without lock	75 xx 141H/VG	638	749	712	754
		Electronic lock	75 xx 141AH/VG	884	994	957	999
		Code lock	75 xx 141BH/VG	712	823	786	828
		Cylinder lock	75 xx 141CH/VG	686	796	760	801
			<i>241xH/VG</i>	67	67	67	67
			<i>86</i>	<i>86</i>	<i>86</i>	<i>86</i>	

Bases, shelves and accessories: see page 81-83
Side and top covers: see page 84

VX

VX Personal Storage

- Basic unit in white direct laminated chipboard
- Depth 432 mm is standard, 500 mm optional
- Hinged doors in white direct laminate, veneer and optional NCS
- Electronical locks: Mifare 13,56 MHz, battery incl.
- Battery replacement is recom. at 2-year intervals.
- User card Mifare not included, order separately
- Network-basd locks against quotation
- Labeling of cabinets against quotation
- Adjustable shelves are ordered separately
- Bases are ordered separately
- Side covers and tops in veneer are optional
- Should be anchored to the wall due to tipping risk
- For more product information, see www.horreds.se



Basic units: White direct laminate, closest NCS S0300-N (31).

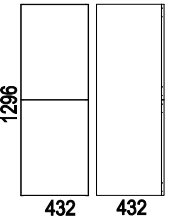
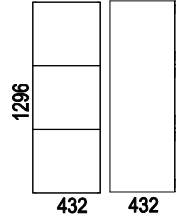
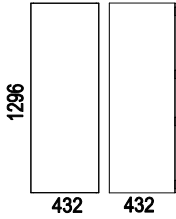
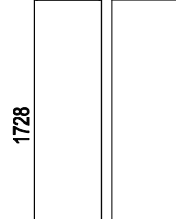
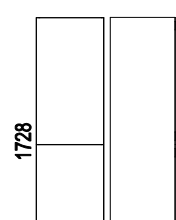
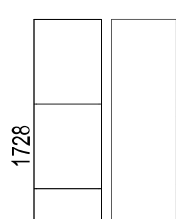
Doors white direct laminate: closest NCS S0300-N (31).

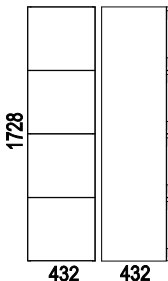
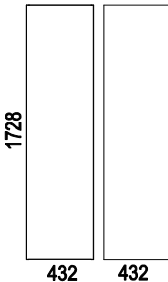
Doors coloured lacquer: Optional NCS (99).

Doors veneer group 1: Oak (03), Ash (06).

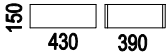
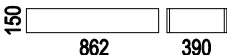
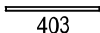


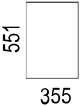
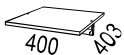
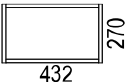
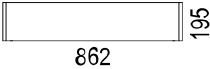
Doors veneer group 2: White oak (30), White Ash (10), Black Ash (86) Dark Ash (76), Stained ash Burqundy (C8), Stained ash Conifer (D3), Stained ash Smokey Blue (D4).

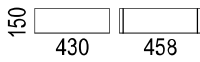
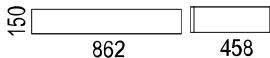
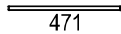
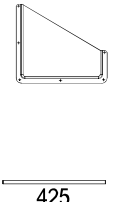

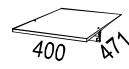
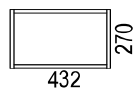
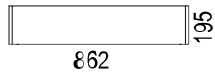
		<u>Door model</u>	<u>Article number</u>	<u>White</u>	<u>NCS</u>	<u>Veneer 1</u>	<u>Veneer 2</u>
	Storage white dir.lam. 432x432x432 mm incl 1 door <i>Upcharge for depth 500 mm</i>	Push-open, no lock	34 xx 111H/V	251	311	301	321
		Electronic lock	34 xx 111AH/V	474	534	524	543
		Code lock	34 xx 111BH/V	316	376	365	386
		Cylinder lock	34 xx 111CH/V	291	351	341	361
			<i>211xH/V</i>	<i>51</i>	<i>51</i>	<i>51</i>	<i>51</i>
	Storage white dir.lam. 432x432x864 mm incl 1 door Shelves not included, order separately <i>Upcharge for depth 500 mm</i>	Push-open, no lock	34 xx 121H/V	271	351	351	378
		Electronic lock	34 xx 121AH/V	493	573	573	601
		Code lock	34 xx 121BH/V	336	415	415	443
		Cylinder lock	34 xx 121CH/V	311	391	391	418
			<i>221xH/V</i>	<i>61</i>	<i>61</i>	<i>61</i>	<i>61</i>
	Storage white dir.lam. 432x864x432 mm incl 2 doors and 1 stationary shelf. <i>Upcharge for depth 500 mm</i>	Push-open, no lock	34 xx 122H/V	370	490	461	500
		Electronic lock	34 xx 122AH/V	816	936	906	946
		Code lock	34 xx 122BH/V	500	620	590	630
		Cylinder lock	34 xx 122CH/V	450	570	540	580
			<i>222xH/V</i>	<i>61</i>	<i>61</i>	<i>61</i>	<i>61</i>
	Storage white dir.lam. 432x1296x432 mm incl 1 door Shelves not included, order separately <i>Upcharge for depth 500 mm</i>	Push-open, no lock	34 xx 131H/V	370	470	465	500
		Electronic lock	34 xx 131AH/V	593	693	688	723
		Code lock	34 xx 131BH/V	435	535	530	565
		Cylinder lock	34 xx 131CH/V	410	510	505	540
			<i>231xH/V</i>	<i>73</i>	<i>73</i>	<i>73</i>	<i>73</i>


		<u>Door model</u>	<u>Article number</u>	<u>White</u>	<u>NCS</u>	<u>Veneer 1</u>	<u>Veneer 2</u>
	Storage white dir.lam. 432x1296x432 mm incl 2 doors. Extra shelves to be ordered separately. <i>Upcharge for depth 500 mm</i>	Push-open, no lock Electronic lock Code lock Cylinder lock	34 xx 132H/V 34 xx 132AH/V 34 xx 132BH/V 34 xx 132CH/V 232xH/V	406 851 535 485 73	565 1 010 695 644 73	550 995 679 630 73	605 1 050 734 685 73
	Storage white dir.lam. 432x1296x432 mm incl 3 doors and 2 stationary shelves. <i>Upcharge for depth 500 mm</i>	Push-open, no lock Electronic lock Code lock Cylinder lock	34 xx 133H/V 34 xx 133AH/V 34 xx 133BH/V 34 xx 133CH/V 233xH/V	495 1 164 690 615 73	675 1 343 869 794 73	620 1 288 814 739 73	679 1 348 874 799 73
	Wardrobe white dir.lam. 432x1296x432 mm incl 1 door and anchor hook. Incl 2 removable shelves. <i>Upcharge for depth 500 mm</i>	Push-open, no lock Electronic lock Code lock Cylinder lock	34 xx 131H/VG 34 xx 131AH/VG 34 xx 131BH/VG 34 xx 131CH/VG 231xH/VG	475 698 540 515 73	575 798 640 615 73	575 798 640 615 73	610 833 675 650 73
	Storage white dir.lam. 432x1728x432 mm incl 1 door and 1 stationary shelf. Extra shelves to be ordered separately. <i>Upcharge for depth 500 mm</i>	Push-open, no lock Electronic lock Code lock Cylinder lock	34 xx 141H/V 34 xx 141AH/V 34 xx 141BH/V 34 xx 141CH/V 241xH/V	450 673 515 490 86	575 798 640 615 86	565 788 630 605 86	605 827 669 644 86
	Storage white dir.lam. 432x1728x432 mm incl 2 doors Shelves not included, order separately <i>Upcharge for depth 500 mm</i>	Push-open, no lock Electronic lock Code lock Cylinder lock	34 xx 142H/V 34 xx 142AH/V 34 xx 142BH/V 34 xx 142CH/V 242xH/V	465 911 595 545 86	625 1 070 754 704 86	610 1 055 739 690 86	665 1 110 794 745 86
	Storage white dir.lam. 432x1728x432 mm incl 3 doors and 2 stationary shelves. <i>Upcharge for depth 500 mm</i>	Push-open, no lock Electronic lock Code lock Cylinder lock	34 xx 143H/V 34 xx 143AH/V 34 xx 143BH/V 34 xx 143CH/V 243xH/V	579 1 319 809 732 86	818 1 558 1 048 972 86	739 1 479 968 892 86	818 1 558 1 048 972 86

		<u>Door model</u>	<u>Artikelnummer</u>	<u>White</u>	<u>NCS</u>	<u>Veneer 1</u>	<u>Veneer 2</u>
	Storage white dir.lam. 432x1728x432 mm incl 4 doors and 3 stationary shelves. <i>Upcharge for depth 500 mm</i>	Push-open, no lock	34 xx 144H/V	625	864	784	864
		Electronic lock	34 xx 144AH/V	1 516	1 755	1 675	1 755
		Code lock	34 xx 144BH/V	884	1 123	1 043	1 123
		Cylinder lock	34 xx 144CH/V	784	1 024	944	1 024
			<i>244xH/V</i>	86	86	86	86
	Wardrobe white dir.lam. 432x1728x432 mm incl 1 dor and anchor hook. Incl 2 removable shelves. <i>Upcharge for depth 500 mm</i>	Push-open, no lock	34 xx 141H/VG	550	675	664	704
		Electronic lock	34 xx 141AH/VG	773	897	887	927
		Code lock	34 xx 141BH/VG	615	739	729	769
		Cylinder lock	34 xx 141CH/VG	590	715	704	744
			<i>241xH/VG</i>	86	86	86	86

Bases, shelves and accessories: see page 81-83
Side and top covers: see page 84

TILLBEHÖR				
Accessories to Biblio/Siglo/Tetris/VX Personal Storage				
<ul style="list-style-type: none"> • White direct laminate = closest NCS S0300-N • For more product information, see www.horreds.se 				
Accessories to units in depth 432 mm				
	Base 430 mm, H: 150 mm Incl clamping knobs. For units with standard depth 432 mm	White dir.laminate	34 31 010	111
	Base 862 mm, H: 150 mm Incl clamping knobs. For units with standard depth 432 mm	White dir.laminate	34 31 020	116
	Removable shelf 400x403 mm	White dir.laminate	34 31 07767	39
	Keyboard holder in felt. Inner meas.: W230/D35/H210/80 mm. Attach on inside door. NB: not in combination with the smallest door 432x432 mm.	Anthracite	34 98 08327	55
	Removable shelf 400x 357 mm. Used in combination with keyboard holder.	White dir.laminate	34 31 08347	39
	Vertical divider H551xL355 mm. Only fits units in height 1728 mm with 3 doors (art 143)	White dir.laminate	34 31 08287	56
	Shelf with wardrobe rod	White dir.laminate	34 31 08278	70
	Shoe shelf incl black, rifled rubber mat, 432x270x415 mm.	White dir.laminate	34 31 001	197
	Add-on module in wood 862x436x195 mm, incl 2 st plant container á 170x790x140 mm in recycled plastic	White lacquer NCS Veener 1 Veener 2	34 31 08460-1 34 99 08460-1 34 xx 08460-1 34 xx 08460-1	378 458 555 608
	Seat cushion: contact us for quotation.			

Accessories to units in depth 500 mm				
	Base 430 mm, H: 150 mm Incl clamping knobs. For units with depth 500 mm	White dir.laminate	34 31 012	120
	Base 862 mm, H: 150 mm Incl clamping knobs. For units with depth 500 mm	White dir.laminate	34 31 022	125
	Removable shelf 400x403 mm. Fits units with depth 500 mm.		34 31 08413	47
	Keyboard holder in felt. Inner meas.: W230/D35/H210/80 mm. Attach on inside door. NB: not in combination with the smallest door 432x432 mm. Removable shelf 400x 357 mm. Used in combination with keyboard holder. Fits units with depth 500 mm.	Anthracite White dir.laminate	34 98 08327 34 31 08448	55 47
	Vertical divider H551xL423 mm. Only fits units in height 1728 mm with 3 doors (art 143) Fits units with depth 500 mm.	White dir.laminate	34 31 08447	65
	Shelf with wardrobe rod Fits units with depth 500 mm.	White dir.laminate	34 31 08446	79
	Shoe shelf incl black, rifled rubber mat, 432x270x483 mm. Fits units with depth 500 mm.	White dir.laminate	34 31 002	197
	Add-on module 862x504x195 mm, incl 2 st plant containers á 170x790x140 mm in recycled plastic Fits units with depth 500 mm.	White lacquer NCS Veneer 1 Veneer 2	34 31 08460-2 34 99 08460-2 34 xx 08460-2 34 xx 08460-2	378 458 555 608
	Seat cushion: contact us for quotation.			

Other				
	Portable storage box incl pen tray L343/B223/H240 mm.		34 37 06018	53
	Rubbermat, rifled		34 37 07814	35
	User card for electronic lock		371 781	17
	Battery for electronic lock Flexlock. Replacment is recommended to be done at a 2 years interval. In order to have your Flexlock work optimally it is required to use this Flexlock battery.		376 691	10

PERSONLIG FÖRVARING**Personal Storage Options**

- Tops
- Sides
- Base fronts

- Prices refer to veneer and white lacquer.
- For more product information, see www.horreds.se

Material:

- White lacquer, closest NCS S0300-N (31).
- Veneer: Oak (03), Ash (06), Black ash (86), White oak (30), Dark ash (76), White ash (10), stained ash Burgundy (C8), Stained ash Conifer D3), Stained ash Smokey Blue (D4).
- Option: Optional NCS (99), additional cost € 69 / piece.

COVER PANEL TOPS:

Covers	Length	Shallow unit (depth 440mm)	Deep unit (depth 508mm)	Shallow units back to back (depth 880mm)	Deep units back to back (depth 1013mm)
1 unit	432mm	204	204	408	408
1 unit + side covers	473mm	204	204	408	408
2 units	864mm	238	238	476	476
2 units + side covers	905mm	238	238	476	476
3 units	1296mm	299	299	598	598
3 units + side covers	1337mm	299	299	598	598
4 units	1728mm	346	346	691	691
4 units + side covers	1769mm	346	346	691	691
5 units	2160mm	389	389	778	778
5 units + side covers	2201mm	389	389	778	778

COVER PANEL SIDES:

Covers	Height	Shallow unit (depth 437mm)	Deep unit (depth 505mm)	Shallow units back to back (depth 877mm)	Deep units back to back (depth 1010mm)
1 unit	432mm	204	204	408	408
1 unit + base	581mm	204	204	408	408
2 units	864mm	238	238	476	476
2 unit + base	1013mm	238	238	476	476
3 units	1296mm	299	299	598	598
3 unit + base	1445mm	299	299	598	598
4 units	1728mm	346	346	691	691
4 unit + base	1877mm	346	346	691	691

COVER PANEL PLINTHS:

Covers	Length	Height 149 mm
1 unit	432mm	68
2 units	864mm	80
3 units	1296mm	100
4 units	1728mm	115
5 units	2160mm	130



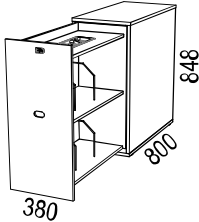
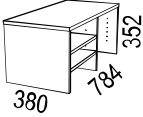
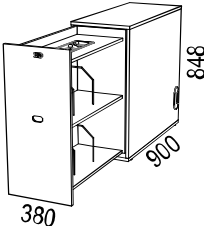
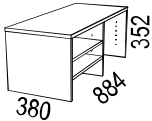
Illustration	Description	Article number	Material	EUR
<p>Biblio Design: Anderssen & Voll</p>				
	<p>Biblio Side Storage</p> <ul style="list-style-type: none"> • Side storage in direct laminated or veneered particle board. • Doors in lacquered or veneered MDF with handles in veneered steel. • The inside is always white. • Stationary shelves. • With clamping knobs. • Max weight capacity: 50 kg. • Lockable. • Chose left or right; images below show units for placement on left side of desk • Can be easily rebuilt from left to right and vice versa. • Note: Dimensions and design changed from 2022. • For additional product information: please see www.horreds.se <p>Material: <u>Veneer group 1:</u> Oak (03), Ash (06) <u>Veneer group 2:</u> Blackst.ash (86), Darkst. ash (76), White pigm.oak(30), White pigm.ash (10) <u>White direct laminate:</u> closest NCS S0300-N</p>	 <p>Colour handles: 03 Oak 06 Ash 75 Black ash 76 Dark ash 30 White Oak 10 White ash 31 White (RAL 9016)</p>		
 	<p>Biblio side storage height 2xA4. <u>Depth 800 mm.</u> Incl.pen tray and brackets.</p> <p><i>Upcharge for front in optional NCS</i> <i>Upcharge for veneered front to white unit</i></p> <p>Open top storage height 1xA4.</p> <p><i>Article numer for side storage prepared for top storage</i></p>	<p>64 3131xx 11BV/H 64 xxxxxx 11BV/H 64 xxxxxx 11BV/H</p> <p>57 31 06400 57 xx 06400 57 xx 06400</p> <p>64 xx 11DV/H</p>	<p>White Veneer group 1 Veneer group 2</p>	<p>1 125 1 707 1 918 231 231</p> <p>318 622 715</p>
 	<p>Biblio side storage height 2xA4. <u>Depth 900 mm.</u> Incl.pen tray and brackets.</p> <p><i>Upcharge for front in optional NCS</i> <i>Upcharge for veneered front to white unit</i></p> <p>Open top storage height 1xA4.</p> <p><i>Article numer for side storage prepared for top storage</i></p>	<p>64 3131xx 12BV/H 64 xxxxxx 12BV/H 64 xxxxxx 12BV/H</p> <p>57 31 06410 57 xx 06410 57 xx 06410</p> <p>64 xx 12DV/H</p>	<p>White Veneer group 1 Veneer group 2</p>	<p>1 194 1 724 1 937 231 231</p> <p>331 644 740</p>

Illustration	Description	Article number	Material	EUR
	Biblio side storage height 3xA4. <u>Depth 800 mm.</u> Incl.pen tray and brackets. <i>Upcharge for front in optional NCS</i> <i>Upcharge for veneered front to white unit</i>	64 3131xx 21BV/H	White	1 266
		64 xxxxxx 21BV/H	Veneer group 1	1 793
		64 xxxxxx 21BV/H	Veneer group 2	2 014
				231
	Biblio side storage height 3xA4. <u>Depth 900 mm.</u> Incl.pen tray and brackets. <i>Upcharge for front in optional NCS</i> <i>Upcharge for veneered front to white unit</i>	64 3131xx 22BV/H	White	1 335
		64 xxxxxx 22BV/H	Veneer group 1	1 811
		64 xxxxxx 22BV/H	Veneer group 2	2 034
				231
BIBLIO SPLIT <ul style="list-style-type: none"> • For 2 users. To be placed between two desks.. • The inside is always white. • Stationary shelves. • Max weight capacity 50 kg. • Not lockable. • Inserts and Hanging file drawer do not fit in Split. 				
	Biblio Split height 3xA4. <u>Depth 800 mm.</u> <i>Upcharge for front in optional NCS</i> <i>Upcharge for veneered front to white unit</i>	64 3131xx 21A	White	1 532
		64 xxxxxx 21A	Veneer group 1	2 058
		64 xxxxxx 21A	Veneer group 2	2 280
				231
	Biblio Split height 3xA4. <u>Depth 900 mm.</u> <i>Upcharge for front in optional NCS</i> <i>Upcharge for veneered front to white unit</i>	64 3131xx 22A	White	1 600
		64 xxxxxx 22A	Veneer group 1	2 076
		64 xxxxxx 22A	Veneer group 2	2 300
				231



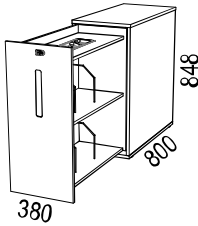
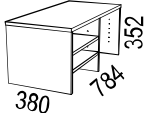
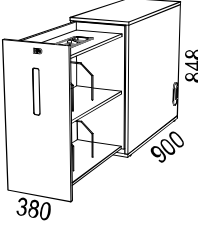
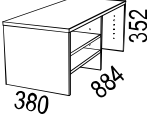
Illustration	Description	Article number	Material	EUR
Nomono Design: Fredrik Mattson				
	<p>Nomono Side Storage</p> <ul style="list-style-type: none"> • Side storage in direct laminated or veneered particle board. • Doors in lacquered or veneered MDF with handles in lacquered steel sheet. • The inside is always white. • Stationary shelves. • With clamping knobs. • Max weight capacity: 50 kg. • Lockable. • Chose left or right; images below show units for placement on left side of desk • Can be easily rebuilt from left to right and vice versa. • Note: Dimensions and design changed from 2022. • For additional product information: please see www.horreds.se <p>Material:</p> <p><u>Veneer group 1:</u> Oak (03), Ash (06)</p> <p><u>Veneer gr. 2:</u> Black ash (86), Dark Ash (76), White oak (30), White ash (10)</p> <p><u>White direct laminate:</u> Closest NCS 0300-N</p> <p>Handle in light brownElmosoft 54035, upcharge € 70.</p>	 <p>Colour handles:</p> <p>31 White</p> <p>37 Black</p> <p>32 Yellow</p> <p>36 Green</p> <p>33 Red</p> <p>35 Blue</p> <p>42 Orange</p>	<p>Closest ncs:</p> <p>S 0300-N</p> <p>S 9000-N</p> <p>S 1070-Y</p> <p>S 2570-G30Y</p> <p>S 1580-Y80R</p> <p>S 0540-B30G</p> <p>S 1080-Y50R</p>	
 	<p>Nomono side storage height 2xA4. <u>Depth 800 mm.</u> Incl.pen tray and brackets.</p> <p><i>Upcharge for front in optional NCS</i> <i>Upcharge for veneered front to white unit</i></p> <p>Open top storage height 1xA4.</p> <p><i>Article numer for side storage prepared for top storage</i></p>	<p>52 3131xx 11BV/H</p> <p>52 xxxxxx 11BV/H</p> <p>52 xxxxxx 11BV/H</p> <p>57 31 06400</p> <p>57 xx 06400</p> <p>57 xx 06400</p> <p>52 xx 11DV/H</p>	<p>White</p> <p>Veneer group 1</p> <p>Veneer group 2</p> <p>White</p> <p>Veneer group 1</p> <p>Veneer group 2</p>	<p>1 103</p> <p>1 685</p> <p>1 896</p> <p>231</p> <p>231</p> <p>318</p> <p>622</p> <p>715</p>
 	<p>Nomono side storage height 2xA4. <u>Depth 900 mm.</u> Incl.pen tray and brackets.</p> <p><i>Upcharge for front in optional NCS</i> <i>Upcharge for veneered front to white unit</i></p> <p>Open top storage height 1xA4.</p> <p><i>Article numer for side storage prepared for top storage</i></p>	<p>52 3131xx 12BV/H</p> <p>52 xxxxxx 12BV/H</p> <p>52 xxxxxx 12BV/H</p> <p>57 31 06410</p> <p>57 xx 06410</p> <p>57 xx 06410</p> <p>52 xx 12DV/H</p>	<p>White</p> <p>Veneer group 1</p> <p>Veneer group 2</p> <p>White</p> <p>Veneer group 1</p> <p>Veneer group 2</p>	<p>1 172</p> <p>1 702</p> <p>1 915</p> <p>231</p> <p>231</p> <p>331</p> <p>644</p> <p>740</p>

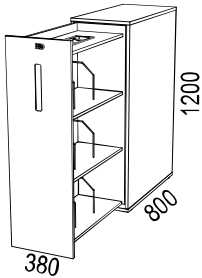
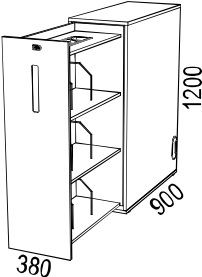
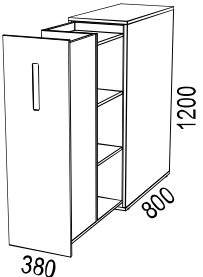
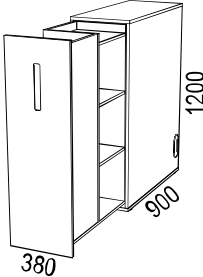
Illustration	Description	Article number	Material	EUR
	Nomono side storage height 3xA4. <u>Depth 800 mm.</u> Incl.pen tray and brackets.	52 3131xx 21BV/H	White	1 244
		52 xxxxxx 21BV/H	Veneer group 1	1 771
		52 xxxxxx 21BV/H	Veneer group 2	1 992
	<i>Upcharge for front in optional NCS</i> <i>Upcharge for veneered front to white unit</i>			231 231
	Nomono side storage height 3xA4. <u>Depth 900 mm.</u> Incl.pen tray and brackets.	52 3131xx 22BV/H	White	1 312
		52 xxxxxx 22BV/H	Veneer group 1	1 788
		52 xxxxxx 22BV/H	Veneer group 2	2 012
	<i>Upcharge for front in optional NCS</i> <i>Upcharge for veneered front to white unit</i>			231 231
<h3>NOMONO SPLIT</h3> <ul style="list-style-type: none"> • For 2 users. To be placed between two desks.. • The inside is always white. • Stationary shelves. • Max weight capacity 50 kg. • Not lockable. • Inserts and Hanging file drawer do not fit in Split. 				
	Nomono Split height 3xA4. <u>Depth 800 mm.</u>	52 3131xx 21A	White	1 509
		52 xxxxxx 21A	Veneer group 1	2 036
		52 xxxxxx 21A	Veneer group 2	2 258
	<i>Upcharge for front in optional NCS</i> <i>Upcharge for veneered front to white unit</i>			231 231
	Nomono Split height 3xA4. <u>Depth 900 mm.</u>	52 3131xx 22A	White	1 578
		52 xxxxxx 22A	Veneer group 1	2 054
		52 xxxxxx 22A	Veneer group 2	2 278
	<i>Upcharge for front in optional NCS</i> <i>Upcharge for veneered front to white unit</i>			231 231



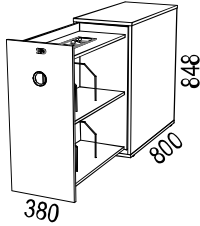
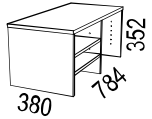
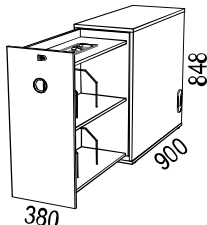
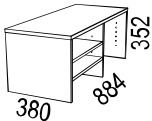
Illustration	Description	Article number	Material	EUR																																													
<p>Siglo Design: Henrik Schulz</p>																																																	
	<p>Siglo Side Storage</p> <ul style="list-style-type: none"> • Side storage in direct laminated or veneered particle board. • Round recess for handle, with ring and plate in white or black plastic as standard. • The inside is always white. • Stationary shelves. • With clamping knobs. • Max weight capacity: 50 kg. • Lockable. • Chose left or right; images below show units for placement on left side of desk • Can be easily rebuilt from left to right and vice versa. • For additional product information; please see www.horreds.se <p>Material: <u>Veneer group 1:</u> Oak (03), Ash (06) <u>Veneer group 2:</u> Blackst.ash (86), Darkst. ash (76), White pigm.oak(30), White pigm.ash (10) <u>White direct laminate:</u> closest NCS S0300-N</p> <p>* Handles in brass or stainless steel: additional fee € 102.</p>		<p>Handles standard: 31 White plastic 37 Black plastic</p> <p>Handles optional*: 16 Brass 17 Stainless</p>																																														
 	<p>Siglo side storage height 2xA4. <u>Depth 800 mm.</u> Incl.pen tray and brackets.</p> <p><i>Upcharge for front in optional NCS</i> <i>Upcharge for veneered front to white unit</i></p> <p>Open top storage height 1xA4.</p> <p><i>Article numer for side storage prepared for top storage</i></p>	<table border="0"> <tr> <td>60</td> <td>3131xx</td> <td>11BV/H</td> <td>White dir.lam.</td> <td>1 056</td> </tr> <tr> <td>60</td> <td>xxxxxx</td> <td>11BV/H</td> <td>Veneer group 1</td> <td>1 612</td> </tr> <tr> <td>60</td> <td>xxxxxx</td> <td>11BV/H</td> <td>Veneer group 2</td> <td>1 813</td> </tr> <tr> <td></td> <td></td> <td></td> <td></td> <td>259</td> </tr> <tr> <td></td> <td></td> <td></td> <td></td> <td>259</td> </tr> <tr> <td>60</td> <td>31</td> <td>06400</td> <td>White dir.lam.</td> <td>356</td> </tr> <tr> <td>60</td> <td>xx</td> <td>06400</td> <td>Veneer group 1</td> <td>696</td> </tr> <tr> <td>60</td> <td>xx</td> <td>06400</td> <td>Veneer group 2</td> <td>801</td> </tr> <tr> <td>60</td> <td>xx</td> <td>11DV/H</td> <td></td> <td></td> </tr> </table>	60	3131xx	11BV/H	White dir.lam.	1 056	60	xxxxxx	11BV/H	Veneer group 1	1 612	60	xxxxxx	11BV/H	Veneer group 2	1 813					259					259	60	31	06400	White dir.lam.	356	60	xx	06400	Veneer group 1	696	60	xx	06400	Veneer group 2	801	60	xx	11DV/H				
60	3131xx	11BV/H	White dir.lam.	1 056																																													
60	xxxxxx	11BV/H	Veneer group 1	1 612																																													
60	xxxxxx	11BV/H	Veneer group 2	1 813																																													
				259																																													
				259																																													
60	31	06400	White dir.lam.	356																																													
60	xx	06400	Veneer group 1	696																																													
60	xx	06400	Veneer group 2	801																																													
60	xx	11DV/H																																															
 	<p>Siglo side storage height 2xA4. <u>Depth 900 mm.</u> Incl.pen tray and brackets.</p> <p><i>Upcharge for front in optional NCS</i> <i>Upcharge for veneered front to white unit</i></p> <p>Open top storage height 1xA4.</p> <p><i>Article numer for side storage prepared for top storage</i></p>	<table border="0"> <tr> <td>60</td> <td>3131xx</td> <td>12BV/H</td> <td>White dir.lam.</td> <td>1 129</td> </tr> <tr> <td>60</td> <td>xxxxxx</td> <td>12BV/H</td> <td>Veneer group 1</td> <td>1 631</td> </tr> <tr> <td>60</td> <td>xxxxxx</td> <td>12BV/H</td> <td>Veneer group 2</td> <td>1 835</td> </tr> <tr> <td></td> <td></td> <td></td> <td></td> <td>259</td> </tr> <tr> <td></td> <td></td> <td></td> <td></td> <td>259</td> </tr> <tr> <td>60</td> <td>31</td> <td>06410</td> <td>White dir.lam.</td> <td>371</td> </tr> <tr> <td>60</td> <td>xx</td> <td>06410</td> <td>Veneer group 1</td> <td>721</td> </tr> <tr> <td>60</td> <td>xx</td> <td>06410</td> <td>Veneer group 2</td> <td>829</td> </tr> <tr> <td>60</td> <td>xx</td> <td>12DV/H</td> <td></td> <td></td> </tr> </table>	60	3131xx	12BV/H	White dir.lam.	1 129	60	xxxxxx	12BV/H	Veneer group 1	1 631	60	xxxxxx	12BV/H	Veneer group 2	1 835					259					259	60	31	06410	White dir.lam.	371	60	xx	06410	Veneer group 1	721	60	xx	06410	Veneer group 2	829	60	xx	12DV/H				
60	3131xx	12BV/H	White dir.lam.	1 129																																													
60	xxxxxx	12BV/H	Veneer group 1	1 631																																													
60	xxxxxx	12BV/H	Veneer group 2	1 835																																													
				259																																													
				259																																													
60	31	06410	White dir.lam.	371																																													
60	xx	06410	Veneer group 1	721																																													
60	xx	06410	Veneer group 2	829																																													
60	xx	12DV/H																																															

Illustration	Description	Article number	Material	EUR
	Siglo side storage height 3xA4. <u>Depth 800 mm.</u> Incl.pen tray and brackets. <i>Upcharge for front in optional NCS</i> <i>Upcharge for veneered front to white unit</i>	60 3131xx 21BV/H	White dir.lam.	1 207
		60 xxxxxx 21BV/H	Veneer group 1	1 796
		60 xxxxxx 21BV/H	Veneer group 2	2 020
				259
				259
	Siglo side storage height 3xA4. <u>Depth 900 mm.</u> Incl.pen tray and brackets. <i>Upcharge for front in optional NCS</i> <i>Upcharge for veneered front to white unit</i>	60 3131xx 22BV/H	White dir.lam.	1 280
		60 xxxxxx 22BV/H	Veneer group 1	1 815
		60 xxxxxx 22BV/H	Veneer group 2	2 042
				259
				259
<h3>SIGLO SPLIT</h3> <ul style="list-style-type: none"> • For 2 users. To be placed between two desks.. • The inside is always white. • Stationary shelves. • Max weight capacity 50 kg. • Not lockable. • Inserts and Hanging file drawer do not fit in Split. 				
	Siglo Split height 3xA4. <u>Depth 800 mm.</u> <i>Upcharge for front in optional NCS</i> <i>Upcharge for veneered front to white unit</i>	60 3131xx 21A	White dir.lam.	1 489
		60 xxxxxx 21A	Veneer group 1	2 079
		60 xxxxxx 21A	Veneer group 2	2 303
				259
				259
	Siglo Split height 3xA4. <u>Depth 900 mm.</u> <i>Upcharge for front in optional NCS</i> <i>Upcharge for veneered front to white unit</i>	60 3131xx 22A	White dir.lam.	1 563
		60 xxxxxx 22A	Veneer group 1	2 098
		60 xxxxxx 22A	Veneer group 2	2 324
				259
				259

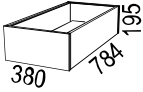
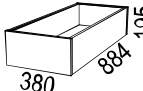
Illustration	Description	Article number	Material	EUR
ACCESSORIES TO SIGLO SIDE STORAGE				
	Add-on module in wood 380x784x195 mm incl. 1 plant container á 170x590x140 mm in recycled plastic	60 31 06365-1 60 xx 06365-1 60 xx 06365-1	White Veneer group 1 Veneer group 2	347 608 650
	Add-on module in wood 380x884x195 mm incl. 1 plant container á 170x790x140 mm in recycled plastic	60 31 06365-2 60 xx 06365-2 60 xx 06365-2	White Veneer group 1 Veneer group 2	347 608 650



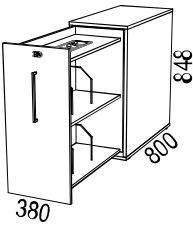
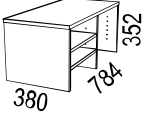
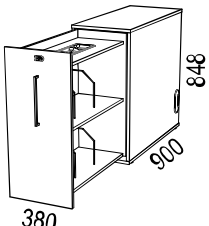
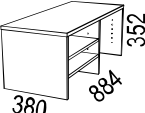
Illustration	Description	Article number	Material	EUR
VX				
<div style="display: flex; justify-content: space-between;"> <div style="width: 25%;">  </div> <div style="width: 50%;"> <h3 style="margin: 0;">VX Side Storage</h3> <ul style="list-style-type: none"> Side storage in direct laminated or veneered particle board. The inside is always white. Stationary shelves. With clamping knobs. Max weight capacity: 50 kg. Lockable. Chose left or right; images below show units for placement on left side of desk Can be easily rebuilt from left to right and vice versa. For additional product information; please see www.horreds.se </div> <div style="width: 20%; text-align: right;">  </div> </div> <div style="margin-top: 20px;"> <p>Material:</p> <p><u>Veneer group 1:</u> Birch (05), Oak (03), Ash (06)</p> <p><u>Veneer group 2:</u> Blackst.ash (86), Darkst. ash (76), White pigm.oak(30), White pigm.ash (10)</p> <p><u>White direct laminate:</u> closest NCS S0300-N</p> </div> <div style="margin-top: 20px;"> <p>Colour handles:</p> <p>31 White</p> <p>37 Black</p> <p>17 Stanless steel look</p> </div>				
 	<p>VX side storage height 2xA4. <u>Depth 800 mm.</u> Incl.pen tray and brackets.</p> <p><i>Upcharge for front in optional NCS</i> <i>Upcharge for veneered front to white unit</i></p> <p>Open top storage height 1xA4.</p> <p><i>Article numer for side storage prepared for top storage</i></p>	<p>34 3131xx 11BV/H</p> <p>34 xxxxxx 11BV/H</p> <p>34 xxxxxx 11BV/H</p> <p>57 31 06400</p> <p>57 xx 06400</p> <p>57 xx 06400</p> <p>34 xx 11DV/H</p>	<p>White dir.lam.</p> <p>Veneer group 1</p> <p>Veneer group 2</p> <p>White dir.lam.</p> <p>Veneer group 1</p> <p>Veneer group 2</p>	<p>942</p> <p>1 438</p> <p>1 618</p> <p>231</p> <p>231</p> <p>318</p> <p>622</p> <p>715</p>
 	<p>VX side storage height 2xA4. <u>Depth 900 mm.</u> Incl.pen tray and brackets.</p> <p><i>Upcharge for front in optional NCS</i> <i>Upcharge for veneered front to white unit</i></p> <p>Open top storage height 1xA4.</p> <p><i>Article numer for side storage prepared for top storage</i></p>	<p>34 3131xx 12BV/H</p> <p>34 xxxxxx 12BV/H</p> <p>34 xxxxxx 12BV/H</p> <p>57 31 06410</p> <p>57 xx 06410</p> <p>57 xx 06410</p> <p>34 xx 12DV/H</p>	<p>White dir.lam.</p> <p>Veneer group 1</p> <p>Veneer group 2</p> <p>White dir.lam.</p> <p>Veneer group 1</p> <p>Veneer group 2</p>	<p>1 007</p> <p>1 455</p> <p>1 637</p> <p>231</p> <p>231</p> <p>331</p> <p>644</p> <p>740</p>

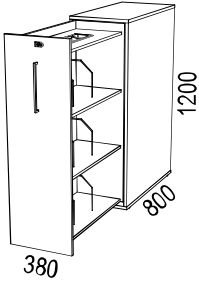
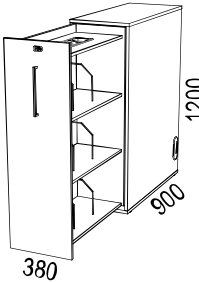
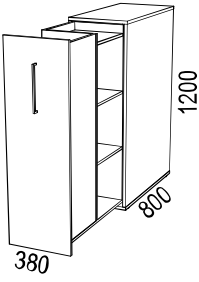
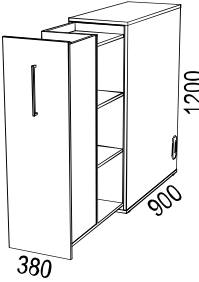
Illustration	Description	Article number	Material	EUR
	<p>VX side storage height 3xA4. <u>Depth 800 mm.</u> Incl.pen tray and brackets.</p> <p><i>Upcharge for front in optional NCS</i> <i>Upcharge for veneered front to white unit</i></p>	<p>34 3131xx 21BV/H 34 xxxxxx 21BV/H 34 xxxxxx 21BV/H</p>	<p>White dir.lam. Veneer group 1 Veneer group 2</p>	<p>1 077 1 602 1 803 231 231</p>
	<p>VX side storage height 3xA4. <u>Depth 900 mm.</u> Incl.pen tray and brackets.</p> <p><i>Upcharge for front in optional NCS</i> <i>Upcharge for veneered front to white unit</i></p>	<p>34 3131xx 22BV/H 34 xxxxxx 22BV/H 34 xxxxxx 22BV/H</p>	<p>White dir.lam. Veneer group 1 Veneer group 2</p>	<p>1 142 1 619 1 821 231 231</p>
<p style="text-align: center;">VX SPLIT</p> <ul style="list-style-type: none"> • For 2 users. To be placed between two desks.. • The inside is always white. • Stationary shelves. • Max weight capacity 50 kg. • Not lockable. • Inserts and Hanging file drawer do not fit in Split. 				
	<p>VX Split height 3xA4. <u>Depth 800 mm.</u></p> <p><i>Upcharge for front in optional NCS</i> <i>Upcharge for veneered front to white unit</i></p>	<p>34 3131xx 21A 34 xxxxxx 21A 34 xxxxxx 21A</p>	<p>White dir.lam. Veneer group 1 Veneer group 2</p>	<p>1 329 1 855 2 055 231 231</p>
	<p>VX Split height 3xA4. <u>Depth 900 mm.</u></p> <p><i>Tillägg för lackad front i valfri NCS</i> <i>Tillägg för fanerad front (stomme i dir.lam)</i></p>	<p>34 3131xx 22A 34 xxxxxx 22A 34 xxxxxx 22A</p>	<p>White dir.lam. Veneer group 1 Veneer group 2</p>	<p>1 394 1 871 2 074 231 231</p>

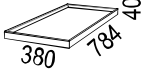
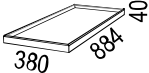
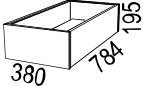
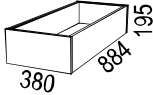
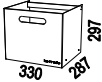





Illustration	Description	Article number	Material	EUR
ACCESSORIES TO SIDE STORAGE				
	Tray 380x784x40 mm	64 xx 08750-080	Veneer group 1	474
		64 xx 08750-080	Veneer group 2	503
	Tray 380x884x40 mm	64 xx 08750-090	Veneer group 1	474
		64 xx 08750-090	Veneer group 2	503
	Add-on module in wood 380x784x195 mm incl. 1 plant container á 170x590x140 mm in recycled plastic	57 31 06365-1	White dir.lam.	311
		57 xx 06365-1	Veneer gr 1	546
		57 xx 06365-1	Veneer gr 1	583
	Add-on module in wood 380x884x195 mm incl. 1 plant container á 170x790x140 mm in recycled plastic	57 31 06365-2	White dir.lam.	311
		57 xx 06365-2	Veneer gr 1	546
		57 xx 06365-2	Veneer gr 1	583
	Hanging file drawer, assembled on expansion track <i>Does not fit in Split.</i>	57 31 03160	White	177
	Shallow insert in direct laminate with fronts in lacquer. 2 drawers. The top drawer incl a plastic pen drawer. <i>Does not fit in Split.</i>	57 31 082	White/White	292
		57 3199 082	White/Opt.NCS fronts	401

Illustration	Description	Article number	Material	EUR
VX				
		VX DRAWER PEDESTAL  <ul style="list-style-type: none"> • In direct laminated or veneered particle board • Back in melamine • For additional product information please see www.horreds.se <p>Material: <u>Veneer group 1:</u> Birch (05), Oak (03), Ash (06) <u>Veneer group 2:</u> Black Ash (86), Dark Ash (76), White Oak (30), White Ash (09/10) <u>White direct laminat:</u> closest NCS S0300-N (31) <u>Grey dir.lam.:</u> closest NCS: light grey S2000-N (61) / Anthracite NCS 7502-Y (B4)</p> <p>Colour handles: 31 White 37 Black 17 Stainless steel look</p>		
	Pedestal, height 632 mm, with 1 pen drawer and 3 storage drawers. Incl.lock. 4 castors of which 2 have brakes.	34 31xx 023A 34 xxxx 023A 34 xxxx 023A 34 xxxx 023A	White direct lam. Grey direct lam. Veneer group 1 Veneer group 2	729 802 1 014 1 116
	Pedestal, height 632 mm, with 1 pen drawer 1 storage drawer and 1 hanging file drawer. Incl.lock. 4 castors of which 2 have brakes.	34 31xx 024A 34 05xx 024A 34 05xx 024A 34 03xx 024A	White direct lam. Grey direct lam. Veneer group 1 Veneer group 2	799 878 1 094 1 203
	Drawer divider. Installs lengthwise. Divides the drawer depthwise. B. 330 mm H. 70 mm	502 12 -134		4
	Broschure tray. B.330 mm D. 215 mm 5 trays fit into one drawer	500 20 -134		6

MEETING TABLES INFO

Here is a presentation of our various stands for meeting tables.

Information regarding table tops, see next page.

- Fixed T-leg stand in height 73 and 90 cm. White RAL9016 and black RAL 9005.
- Electric T-leg stand in height 70-120 cm for format MA, others formats 73-110 cm. White RAL9016 and black RAL 9005.
- Tables in format MA (max. width 90 cm) is delivered with T-legs in dimension 80x50 mm with standard T-foot 70 cm. Solid foot as an option. Cable entries \varnothing 80 mm and Powerdots max \varnothing 60 mm are suitable for these tables.
- Tables in format MF, MG and MH (max. width 120 cm) are delivered with T-legs in dimension 80x50 mm with solid T-foot 70 cm.
- Tables in formats MG+ and MH+ (width 130-160 cm) are delivered with T-legs in dimension 70x70 mm with solid T-foot 90 cm.
- Bord i format MG+ och MH+ (bredd 130-160 cm) levereras med T-ben i dimension 70x70 mm med massiv T-fot 90 cm.

**VX Project**

- Slanted legs in metal or solid wood.
- White RAL9016, Black RAL9005, Oak / Ash (nature/white pigmented/ dark stained)
- Height 73 and 90 cm.
- Minimum width in standard version is 120 cm due to legroom and cable hole restrictions. If you are interested in a table in width 100 or 90 cm; contact us for a suggestion/quote.

**A-Frame**

Design: Anderssen & Voll

- A-stand in solid oak or ash (nature/white pigmented/black stained) with steel legs in white RAL9016 alt. Black RAL9005.
- Fits table sizes 1800-2400 x 900-1200 mm.
- Fixed table height 73 and 90 cm.
- Electric table height 70-120 cm for format MA, 73-110 cm for format MG.



Bordsmaterial:**Högtryckslaminat:**

Högtryckslaminat:	Närmaste NCS:
White HPL 0754 (31)	S0502-Y
Light grey HPL 0419 (2A)	S2002-Y
Light grey HPL1365 (2B)	S2005-R80B
Medium grey HPL 1023 (2C)	S5500-N
Anthracite HPL 1397 (2D)	S7500-N
Black HPL 2253 (2E)	S9000-N

Linoleum:

Linoleum:	Closest NCS:
4132 Ash	5502-G
4154 Burgundy	7010-R10B
4166 Charcoal	8502-B
4172 Mauve	7005-Y80R
4174 Conifer	8010-B90G
4175 Pebble	3502-Y
4176 Mushroom	2002-Y
4177 Vapour	2005-G10Y
4179 Smokey Blue	7010-R90B
4184 Olive	5010-G50Y

Veneer group 1:

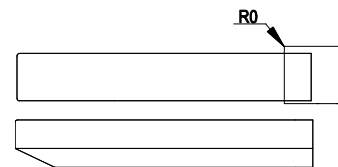
Birch* (05)
Oak (03)
Ash (06)

Veneer group 2:

White pigm. oak (30)**
Black stained ash (86)**
White pigmented ash (10)**
Dark stained ash (76)**
Burgundy stained ash (C8)**
Conifer stained ash (D3)**
Smokey Blue stain.ash (D4)**

*=*not A-frame***=*not Henry***Table tops:****VX**

- VX desk tops are made of 19 mm MDF with edging in matching colour.
- Option: chamfered edge
- Corner radius 0 mm.

**Henry**

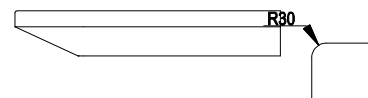
Design: sandellsandberg

- Henry desk tops are made of 19 mm MDF with white plastic edge.
- Corner radius 80 mm.

**Fri**

Design: Bror Boije

- Fri desk tops are made of 19 mm MDF with chamfered, clear coated edge.
- Corner radius 30 mm.

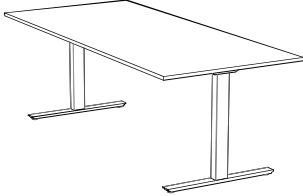
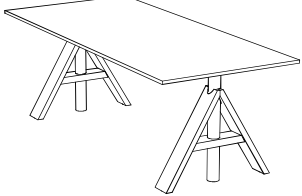
**A-Frame**

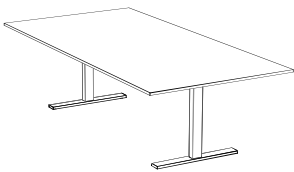
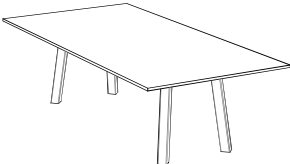
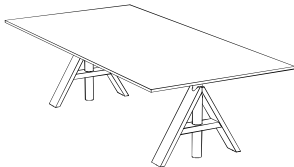
Design: Anderssen & Voll

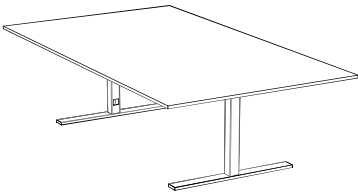

- A-Frame desk tops are made of 19 mm MDF with edging in matching colour.
- Corner radius 0 mm.



- For more product information see www.horreds.se

MEETING TABLES						
<h1>MA</h1> Meeting tables within size 2000x900 mm.						
VX T-legs are delivered with 700 mm standard foot, massive foot as option. A-Frame is delivered with a leg stand in solid wood and legs in steel. This format is not possible with a centered cable cover. When ordering, state the desired table size, profile, material and colour and height of the stand.						
Table top (excluding legs)	White HPL (31)	Optional HPL (39)	Linoleum (88)	Veneer group 1	Veneer group 2	
Series: Radius: Edge profile: VX (3416) 0 mm Straight / matching list VX (3417) 0 mm Chamfered / matching list Fri (3513) 30 mm Chamfered / MDF Henry (80) 80 mm Straight / white pp-list A-Frame (64) 0mm Straight / matching list Possible cable entrie max ø 80 and Powerdot max ø 60 mm.	482	592	702	488	579	
	594	704	814	600	690	
	528	642	801	487	581	
	515	629	789	528		
	516	633	752	523	619	
Stand (excluding table top):						
	White (31)	Black (37)	Chrome (13)	Oak (03) Ash (06)	Stain / White pigm.	
VX T-legs fixed table height 73cm	602	602				
VX T-legs fixed table height 90cm	629	629				
VX T-legs electrical 61-126 cm	1 193	1 193				
Upcharge for massive feet	202	202				
A-Frame fixed table heighth 73cm				985	985	
A-Frame fixed table heighth 90cm				1020	1020	
A-Frame electrial 70-120cm				1917	1917	
Below you find our standard table tops within this format. There might be optional desks available in our table bank. Please contact Customer Service (info@horreds.se) to check availability. If you would like to order a model which is not available in the table bank there will be an additional cost of € 207.						
<h3>VX T-legs</h3>  <p>Sizes: Length 1800-2000 mm Width 900 mm</p>			<h3>A-Frame</h3>  <p>Sizes: Length 1800-2000 mm Width 900 mm</p>			

MEETING TABLES							
<h1>MF</h1> Meeting tables within size 2400x1200 mm.							
VX T-legs are delivered with solid steel foot 700 mm. VX Project Stand is delivered with slanted legs in wood or metal. A-Frame is delivered with a leg stand in solid wood and legs in steel. When ordering, state the desired table size, profile, material and colour and height of the stand.							
Table top (excluding legs)	White dir. laminate (31D)	White HPL (31)	Optional HPL (39)	Linoleum (88)	Veneer group 1	Veneer group 2	
Series: Radius: Edge profile: VX (3416) 0 mm Straight / matching list VX (3417) 0 mm Chamfered / matching list Fri (3513) 30 mm Chamfered / MDF Henry (80) 80 mm Straight / white pp-list A-Frame (64) 0mm Straight / matching list	661	696	751	1 115	803	911	
	697	732	787	1 151	849	957	
	734	771	828	1 212	893	1 008	
	696	733	790	1 174	845		
	696	733	790	1 174	845	959	
Stand (excluding table top):			White (31)	Black (37)	Chrome (13)	Oak (03) / Ash (06)	Stain / White pigm.
VX Conference, 2xT-legs with solid 70cm foot, table height 73cm			886	886	2 634		
VX Conference, 2xT-legs with solid 70cm foot, table height 90cm			913	913	2 929		
VX Conference 2xT-legs electrical 73-110cm			1 519	1 519			
VX Project, 4xlegs, steel frame, table height 73cm			1 366	1 366		1 366	1 445
VX Project, 4xlegs, steel frame, table height 90cm			1 513	1 513		1 513	1 592
A-Frame conference, white / black legs, table height 73cm						1 194	1 194
A-Frame conference, white / black legs, table height 90cm						1 228	1 228
A-frame conference electrical 73-110cm						2 089	2 089
Below you find our standard table tops within this format. There might be optional desks available in our table bank. Please contact Customer Service (info@horreds.se) to check availability. If you would like to order a model which is not available in the table bank there will be an additional cost of € 207.							
VX Conference  Sizes: Length 2000-2400 mm Width 900-1200 mm		VX Project  Sizes: Length 2000-2400 mm Width 1200 mm		A-Frame  Sizes: Length 2000-2400 mm Width 900-1200 mm			

MEETING TABLES							
<h1>MF+</h1> Meeting tables within size 2400x1400 mm.							
VX Conference is delivered with solid steel foot 900 mm. Wiring through the leg possible. VX Project Stand is delivered with slanted legs in wood or metal. When ordering, state the desired table size, profile, material and colour and height of the stand.							
Table top (excluding legs)	White dir. laminate (31D)	White HPL (31)	Optional HPL (39)	Linoleum (88)	Veneer group 1	Veneer group 2	
Series: Radius: Edge profile: VX (3416) 0 mm Straight / matching list VX (3417) 0 mm Chamfered / matching list Fri (3513) 30 mm Chamfered / MDF Henry (80) 80 mm Straight / white pp-list	721	1 153		1 409	1 640	1 858	
	757	1 189		1 445	1 687	1 904	
	797	1 252		1 521	1 775	2 004	
	760	1 214		1 483			
Stand (excluding table top):			White (31)	Black (37)	Chrome (13)	Oak (03) Ash (06)	Stain / White pigm.
VX Conference, 2xT-legs with solid 90cm foot, table height 73cm			1 757	1 757	2 634		
VX Conference, 2xT-legs with solid 90cm foot, table height 90cm			1 859	1 859	2 929		
VX Conference 2xT-legs electrical 70-106cm			3 551	3 551			
VX Project, 4xlegs, steel frame, table height 73cm			1 366	1 366		1 366	1 445
VX Project, 4xlegs, steel frame, table height 90cm			1 513	1 513		1 513	1 592
Below you find our standard table tops within this format. There might be optional desks available in our table bank. Please contact Customer Service (info@horreds.se) to check availability. If you would like to order a model which is not available in the table bank there will be an additional cost of € 207.							
VX Conference 		VX Project 					
Sizes: Length 2000-2400 mm Width 1300-1400 mm		Sizes: Length 2000-2400 mm Width 1300-1400 mm					

MEETING TABLES

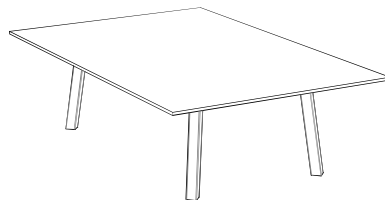
MF++ Meeting tables within size 2400x1600 mm.

VX Project Stand is delivered with slanted legs in wood or metal.
When ordering, state the desired table size, profile, material and colour and height of the stand.

Table top (excluding legs)	White dir. laminate (31D)	White HPL (31)	Optional HPL (39)	Linoleum (88)	Veneer group 1	Veneer group 2
Series: VX (3416) Radius: 0 mm Edge profile: Straight / matching list	982	1 522		1 915	1 828	2 045
Stand (excluding table top):						
	White (31)	Black (37)	Chrome (13)	Oak (03) Ash (06)	Stain / White pigm.	
VX Project, 4xlegs, steel frame, table height 73cm	1 366	1 366		1 366	1 445	
VX Project, 4xlegs, steel frame, table height 90cm	1 513	1 513		1 513	1 592	

Below you find our standard table tops within this format. There might be optional desks available in our table bank.
Please contact Customer Service (info@horreds.se) to check availability. If you would like to order a model which is not available in the table bank there will be an additional cost of € 207.

VX Projekt



Sizes:

Length 2000-2400 mm

Width 1500-1600 mm

MEETING TABLES

MG

2-piece Meeting tables within size 4800x1200

VX T-legs are delivered with solid steel foot 700 mm.

VX Project Stand is delivered with slanted legs in wood or metal.

When ordering, state the desired table size, profile, material and colour and height of the stand.

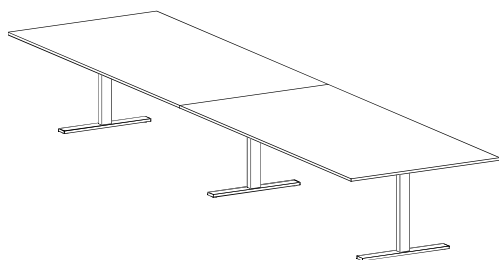
Table top (excluding legs)	White dir. laminate (31D)	White HPL (31)	Optional HPL (39)	Linoleum (88)	Veneer group 1	Veneer group 2
Series: Radius: Edge profile:						
VX (3416) 0 mm Straight / matching list	1 431	1 501	1 556	2 339	1 713	1 931
VX (3417) 0 mm Chamfered / matching list	1 503	1 574	1 628	2 411	1 806	2 024
Fri (3513) 30 mm Chamfered / MDF	1 582	1 656	1 713	2 538	1 901	2 131
Henry (80) 80 mm Straight / white pp-list	1 506	1 580	1 638	2 462	1 804	

Stand (excluding table top):	White (31)	Black (37)	Chrome (13)	Oak (03) Ash (06)	Stain / White pigm.
VX Conference , 3xT-legs with solid 70cm foot, table height 73cm	1 512	1 512	3 921		
VX Conference , 3xT-legs with solid 70cm foot, table height 90cm	1 553	1 553	4 364		
VX Project , 4xlegs, aluminium frame, table height 73cm	2 450	2 450		2 450	2 528
VX Project , 4xlegs, aluminium frame, table height 90cm	2 597	2 597		2 597	2 675
VX Projekt , 6xkegs steel frame, table height 73cm	2 297	2 297		2 297	2 414
VX Projekt , 6xkegs steel frame, table height 90cm	2 515	2 515		2 515	2 633

Below you find our standard table tops within this format. There might be optional desks available in our table bank.

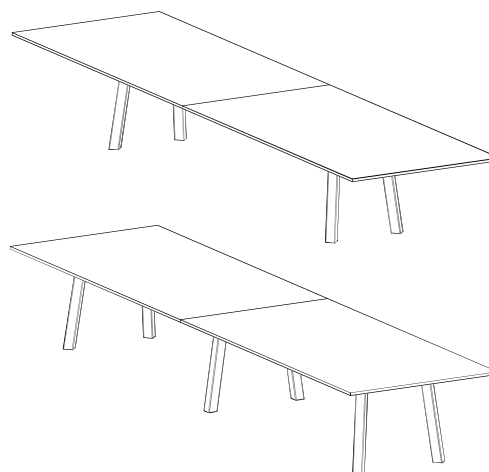
Please contact Customer Service (info@horreds.se) to check availability. If you would like to order a model which is not available in the table bank there will be an additional cost of € 207.

VX Conference

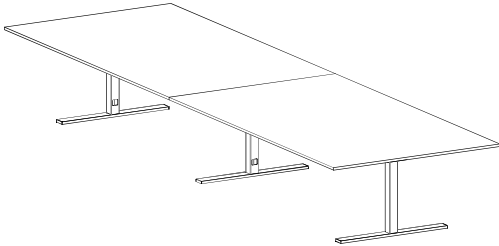
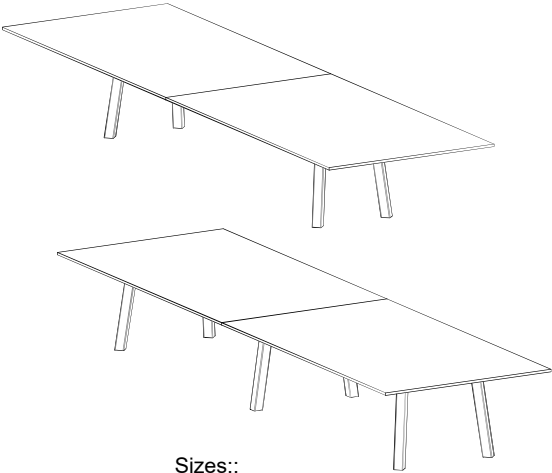


Storlekar:
Length max 4800 mm
Width 1500-1600 mm

VX Project



Storlekar:
Length max 4800 mm
Width 1500-1600 mm

MEETING TABLES						
<h1>MG+</h1> <p>2-piece Meeting tables within size 4800x1400</p> <p>VX T-legs are delivered with solid steel foot 700 mm. VX Project Stand is delivered with slanted legs in wood or metal. When ordering, state the desired table size, profile, material and colour and height of the stand.</p>						
Table top (excluding legs)	White dir. laminate (31D)	White HPL (31)	Optional HPL (39)	Linoleum (88)	Veneer group 1	Veneer group 2
Series: Radius: Edge profile: VX (3416) 0 mm Straight / matching list VX (3417) 0 mm Chamfered / matching list Fri (3513) 30 mm Chamfered / MDF Henry (80) 80 mm Straight / white pp-list	1 552	2 415		2 927	3 389	3 824
	1 623	2 488		2 999	3 482	3 917
	1 709	2 618		3 157	3 665	4 123
	1 633	2 543		3 081		
Stand (excluding table top):		White (31)	Black (37)	Chrome (13)	Oak (03) Ash (06)	Stain / White pigm.
VX Conference, 3xT-legs with solid 70cm foot, table height 73cm		2 883	2 883	4 198		
VX Conference, 3xT-legs with solid 70cm foot, table height 90cm		3 035	3 035	4 641		
VX Project, 4xlegs, aluminium frame, table height 73cm		2 450	2 450		2 450	2 528
VX Project, 4xlegs, aluminium frame, table height 90cm		2 597	2 597		2 597	2 675
VX Projekt, 6xkegs steel frame, table height 73cm		2 297	2 297		2 297	2 414
VX Projekt, 6xkegs steel frame, table height 90cm		2 515	2 515		2 515	2 633
Below you find our standard table tops within this format. There might be optional desks available in our table bank. Please contact Customer Service (info@horreds.se) to check availability. If you would like to order a model which is not available in the table bank there will be an additional cost of € 207.						
<p>VX Conference</p>  <p>Sizes: Length max 4800 mm Width 1300-1400 mm</p>			<p>VX Project</p>  <p>Sizes: Length max 4800 mm Width 1300-1400 mm</p>			

MEETING TABLES

MG++ 2-piece Meeting tables within size 4800x1600

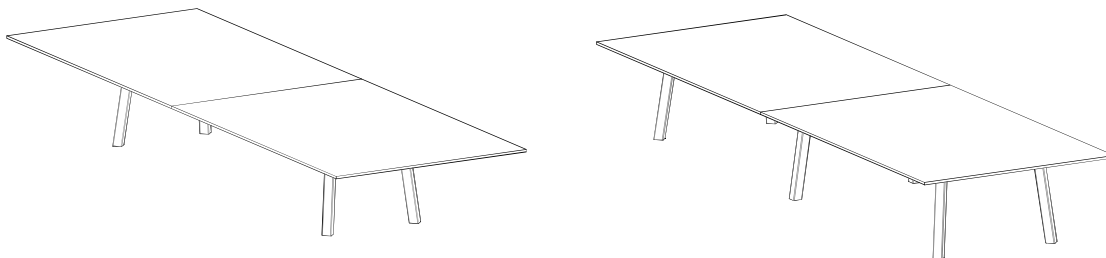
VX Project Stand is delivered with slanted legs in wood or metal.

When ordering, state the desired table size, profile, material and colour and height of the stand.

Table top (excluding legs)	White dir. laminate (31D)	White HPL (31)	Optional HPL (39)	Linoleum (88)	Veneer group 1	Veneer group 2
Series: VX (3416) Radius: 0 mm Edge profile: Straight / matching list	2 073	3 165		3 950	3 765	4 200
Stand (excluding table top):						
	White (31)	Black (37)	Chrome (13)	Oak (03) Ash (06)	Stain / White pigm.	
VX Project, 4xlegs, aluminium frame, table height 73cm	2 450	2 450		2 450	2 528	
VX Project, 4xlegs, aluminium frame, table height 90cm	2 597	2 597		2 597	2 675	
VX Projekt, 6xkegs steel frame, table height 73cm	2 297	2 297		2 297	2 414	
VX Projekt, 6xkegs steel frame, table height 90cm	2 515	2 515		2 515	2 633	

Below you find our standard table tops within this format. There might be optional desks available in our table bank. Please contact Customer Service (info@horreds.se) to check availability. If you would like to order a model which is not available in the table bank there will be an additional cost of € 207.

VX Projekt



Sizes:

Length max 4800 mm

Width 1500-1600 mm

MEETING TABLES

MH

3-piece Meeting tables within size 7200x1200

VX T-legs are delivered with solid steel foot 700 mm.

VX Project Stand is delivered with slanted legs in wood or metal.

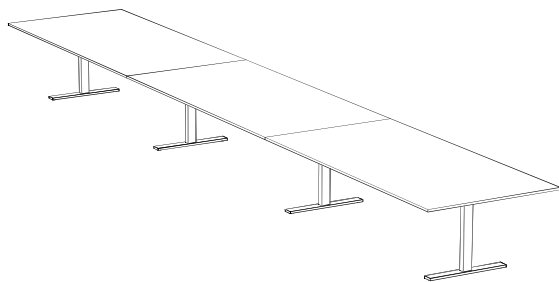
When ordering, state the desired table size, profile, material and colour and height of the stand.

Table top (excluding legs)	White dir. laminate (31D)	White HPL (31)	Optional HPL (39)	Linoleum (88)	Veneer group 1	Veneer group 2
Series: Radius: Edge profile: VX (3416) 0 mm Straight / matching list VX (3417) 0 mm Chamfered / matching list Fri (3513) 30 mm Chamfered / MDF Henry (80) 80 mm Straight / white pp-list	2 146	2 252	2 334	3 509	2 570	2 897
	2 254	2 360	2 442	3 617	2 710	3 036
	2 373	2 485	2 570	3 808	2 852	3 196
	2 259	2 371	2 457	3 694	2 706	
Stand (excluding table top):	White (31)	Black (37)	Chrome (13)	Oak (03) Ash (06)	Stain / White pigm.	
VX Conference , 4xT-legs with solid 70cm foot, table height 73cm	2 125	2 125	5 139			
VX Projekt , 8xlegs, steel frame, table height 73cm	3 227	3 227		3 227	3 383	

Below you find our standard table tops within this format. There might be optional desks available in our table bank.

Please contact Customer Service (info@horreds.se) to check availability. If you would like to order a model which is not available in the table bank there will be an additional cost of € 207.

VX Conference

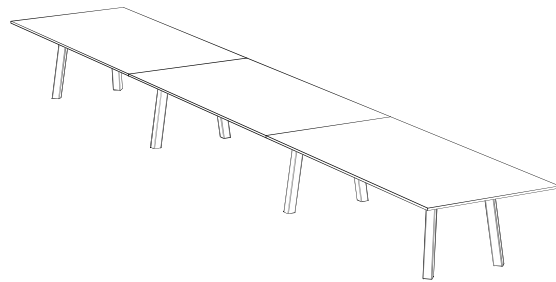


Sizes:

Length max 7200 mm

Width 1000-1200 mm

VX Project



Sizes:

Length max 7200 mm

Width 1000-1200 mm

MOTESBORD
MEETING TABLES

MH+

3-piece Meeting tables within size 7200x1400

VX Conference is delivered with solid steel foot 900 mm. Wiring through the leg possible.

VX Project Stand is delivered with slanted legs in wood or metal.

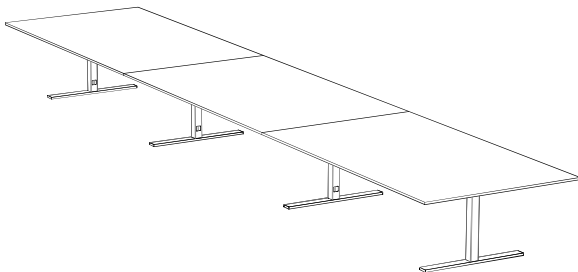
When ordering, state the desired table size, profile, material and colour and height of the stand.

Table top (excluding legs)			White dir. laminate (31D)	White HPL (31)	Optional HPL (39)	Linoleum (88)	Veneer group 1	Veneer group 2
Series:	Radius:	Edge profile:						
VX (3416)	0 mm	Straight / matching list	2 327	3 623		4 390	5 084	5 736
VX (3417)	0 mm	Chamfered / matching list	2 435	3 731		4 499	5 223	5 876
Fri (3513)	30 mm	Chamfered / MDF	2 564	3 928		4 735	5 498	6 185
Henry (80)	80 mm	Straight / white pp-list	2 450	3 814		4 621		
Stand (excluding table top):				White (31)	Black (37)	Chrome (13)	Oak (03) Ash (06)	Stain / White pigm.
VX Conference , 4xT-legs with solid 90cm foot, table height 73cm				4 010	4 010	5 509		
VX Conference , 4xT-legs with solid 90cm foot, table height 90cm				4 213	4 213	6 100		
VX Projekt , 8xlegs, steel frame, table height 73cm				3 227	3 227		3 227	3 383

Below you find our standard table tops within this format. There might be optional desks available in our table bank.

Please contact Customer Service (info@horreds.se) to check availability. If you would like to order a model which is not available in the table bank there will be an additional cost of € 207.

VX Conference

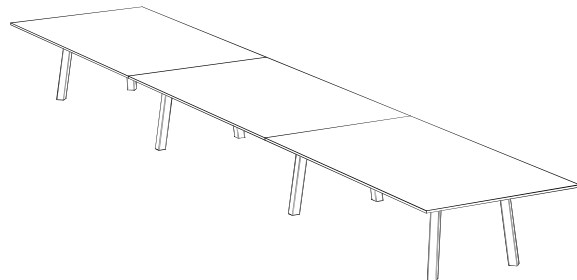


Sizes:

Length max 7200 mm

Width 1300-1400 mm

VX Project



Sizes:

Length max 7200 mm

Width 1300-1400 mm

MEETING TABLES

MH++ 3-piece Meeting tables within size 7200x1600

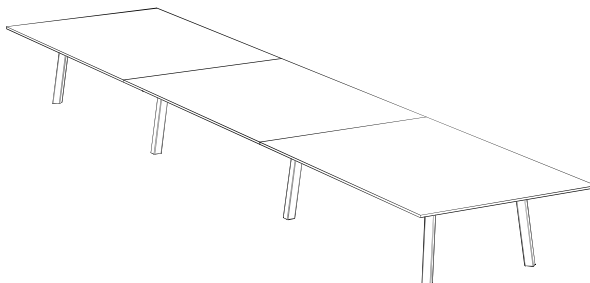
VX Project Stand is delivered with slanted legs in wood or metal.
When ordering, state the desired table size, profile, material and colour and height of the stand.

Table top (excluding legs)	White dir. laminate (31D)	White HPL (31)	Optional HPL (39)	Linoleum (88)	Veneer group 1	Veneer group 2
Series: VX (3416) Radius: 0 mm Edge profile: Straight / matching list	3 163	4 807		5 985	5 701	6 354

Stand (excluding table top):	White (31)	Black (37)	Chrome (13)	Oak (03) Ash (06)	Stain / White pigm.
VX Projekt , 8xlegs, steel frame, table height 73cm	3 227	3 227		3 227	3 383

Below you find our standard table tops within this format. There might be optional desks available in our table bank.
Please contact Customer Service (info@horreds.se) to check availability. If you would like to order a model which is not available in the table bank there will be an additional cost of € 207.

VX Project



Sizes:

Length max 7200 mm

Width 1500-1600 mm

MEETING TABLES

Q

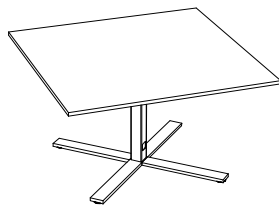
Square tables

VX Conference is delivered with a solid cross base. Wiring through the leg possible.
When ordering, state the desired table size, profile, material and colour and height of the stand.

Table top (excluding legs)			White dir. laminate (31D)	White HPL (31)	Optional HPL (39)	Linoleum (88)	Veneer group 1	Veneer group 2
Series:	Radius:	Edge profile:						
VX (3416)	0 mm	Straight / matching list	368	387	477	477	458	528
VX (3417)	0 mm	Chamfered / matching list	474	500	589	589	570	641
Fri (3513)	30 mm	Chamfered / MDF	504	531	654	654	627	698
Henry (80)	80 mm	Straight / white pp-list	514	541	666	666	640	

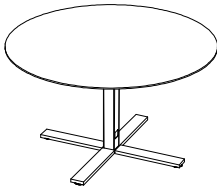
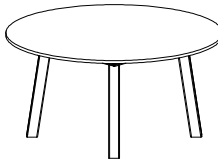
VX Conference Cross foot* in table height	White (31)	Black (37)	Chrome (13)
730 mm for table tops sizes:			
600X600-900x900 mm	445	445	664
Upcharge for stand in height 1060 mm	31	31	203

* Outgoing product, sold only as long as stock lasts. Contact customer support for stock status.



Sizes (mm):

- 600x600
- 700x700
- 800x800
- 900x900

MEETING TABLES									
R1 Round meeting tables max diameter 1400									
VX Conference is delivered with a solid cross base. Wiring through the leg possible. VX Project Stand is delivered with slanted legs in wood or metal. When ordering, state the desired table size, profile, material and colour and height of the stand.									
Series	Radius	Edge profile	White dir. laminate (31D)	White HPL (31)	Optional HPL (39)	Linoleum (88)	Veneer group 1	Veneer group 2	
Round table tops ø 600 - 900 mm (excluding legs)									
VX (3416)	0 mm	Straight / matching list	368	387	477	477	458	528	
VX (3417)	0 mm	Chamfered / matching list	474	500	589	589	570	641	
Fri (3513)	30 mm	Chamfered / MDF	504	531	654	654	627	698	
Round table tops ø 1000 - 1200 mm (excluding legs)									
VX (3416)	0 mm	Straight / matching list	444	468	573	662	529	599	
VX (3417)	0 mm	Chamfered / matching list	551	580	685	774	641	711	
Fri (3513)	30 mm	Chamfered / MDF	608	641	785	907	725	795	
Round table top ø 1400 mm (excluding legs)									
VX (3416)	0 mm	Straight / matching list	721	1 153		1 409	1 640	1 858	
VX (3417)	0 mm	Chamfered / matching list	757	1 189		1 445	1 687	1 904	
Fri (3513)	30 mm	Chamfered / MDF	797	1 252		1 521	1 775	2 004	
Option: cable lid 980									
VX Conference Cross foot * in table height 730 mm for table tops sizes:			White (31)	Black (37)	Chrome (13)				
600-900 mm			445	445	664				
Upcharge for stand in height 1060 mm			31	31	203				
* Utgående produkt, säljes endast så lång lagret räcker. Kontakta kundsupport för lagerstatus.									
VX Project 4xlegs with steel frame:			White (31)	Black (37)	Oak (03) Ash (06)	Stain / White pigm			
Desk height 730 mmm			1 366	1 366	1 366	1 445			
Desk height 900 mm			1 513	1 513	1 513	1 592			
VX Conference  Sizes (mm): Ø 600, 700, 800, 900.			VX Project  Sizes (mm): Ø 1000, 1200, 1400.						

MEETING TABLES

R2

2-piece meeting tables max 2400x2400 mm

VX Project Stand is delivered with slanted legs in wood or metal.

When ordering, state the desired table size, profile, material and colour and height of the stand.

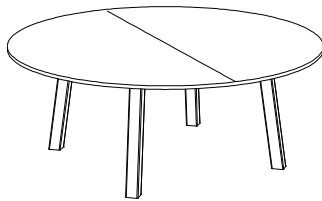
No matching of veneer.

Round table tops ø 1500 - 2400 mm (excluding legs)	White dir. laminate (31D)	White HPL (31)	Optional HPL (39)	Linoleum (88)	Veneer group 1	Veneer group 2
Series: Radius: Edge profile:						
VX (3416) 0 mm Straight / matching list	1 431	1 501	1 556	2 339	1 713	1 931
VX (3417) 0 mm Chamfered / matching list	1 503	1 574	1 628	2 411	1 806	2 024
Fri (3513) 30 mm Chamfered / MDF	1 582	1 656	1 713	2 538	1 901	2 131

Option: cable lid 980

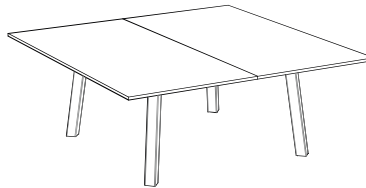
VX Project 4xlegs with steel frame (exck tabke top):	White (31)	Black (37)	Oak (03) Ash (06)	Stain / White pigm.
Table height 73 cm	1 366	1 366	1 366	1 445
Table height 90 cm	1 513	1 513	1 513	1 592

VX Project round table tops



Sizes (mm):
Ø 1500, 1600, 1800, 2000, 2400.

VX Project rectangular table tops



Sizes (mm):
1500X1500, 1600x1600, 1800x1800, 2000x2000, 2400x2400.


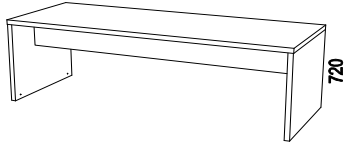
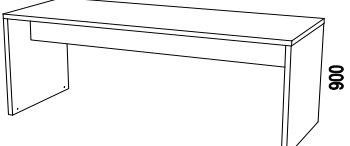
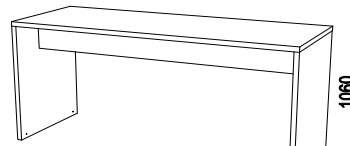
Illustration	Description	Article number	Material	EUR																		
Nomono Conference Design: Fredrik Mattson																						
	<p>Nomono CONFERENCE TABLE</p> <ul style="list-style-type: none"> Nomono conference is made of 38 mm particle board Radius 90 and straight edges with matching pp-list Material: <table border="0" data-bbox="534 369 1173 481"> <tr> <td>White HPL (31)</td> <td>Vitpigmk.ek (30)</td> <td>Burgundy stained ash (C8)</td> </tr> <tr> <td>Oak (03)</td> <td>White ash (10)</td> <td>Conifer stained ash (D3)</td> </tr> <tr> <td>Ash (06)</td> <td>Black ash (86)</td> <td>Smokey Blue stained ash (D4)</td> </tr> <tr> <td></td> <td>Dark ash (76)</td> <td></td> </tr> </table> Distance from edge of desk to middle frame: <ul style="list-style-type: none"> Width 1100 = 420 mm Width 1000 = 370 mm Width 900 = 320 mm Width 800 = 270 mm Width 700 = 220 mm Cable box Bibox and Powerdot PD14 och PD61 fits Nomono Conference. For more product information, please see www.horreds.se 				White HPL (31)	Vitpigmk.ek (30)	Burgundy stained ash (C8)	Oak (03)	White ash (10)	Conifer stained ash (D3)	Ash (06)	Black ash (86)	Smokey Blue stained ash (D4)		Dark ash (76)							
White HPL (31)	Vitpigmk.ek (30)	Burgundy stained ash (C8)																				
Oak (03)	White ash (10)	Conifer stained ash (D3)																				
Ash (06)	Black ash (86)	Smokey Blue stained ash (D4)																				
	Dark ash (76)																					
	<p>Nomono conference in height 720 mm Available lengths: 2400, 2200, 2000, 1800 och 1600 mm.</p> <table border="0" data-bbox="518 828 1452 1176"> <tr> <td rowspan="4">Width 800 or 900 mm</td> <td>White HPL</td> <td>2 433</td> </tr> <tr> <td>Oak / Ash</td> <td>2 915</td> </tr> <tr> <td>Stained Ash</td> <td>3 227</td> </tr> <tr> <td>White Oak / Ash</td> <td>3 227</td> </tr> <tr> <td rowspan="4">Widht 1000 or 1100 mm</td> <td>White HPL</td> <td>2 975</td> </tr> <tr> <td>Oak / Ash</td> <td>3 457</td> </tr> <tr> <td>Stained Ash</td> <td>3 768</td> </tr> <tr> <td>White Oak / Ash</td> <td>3 768</td> </tr> </table>				Width 800 or 900 mm	White HPL	2 433	Oak / Ash	2 915	Stained Ash	3 227	White Oak / Ash	3 227	Widht 1000 or 1100 mm	White HPL	2 975	Oak / Ash	3 457	Stained Ash	3 768	White Oak / Ash	3 768
Width 800 or 900 mm	White HPL	2 433																				
	Oak / Ash	2 915																				
	Stained Ash	3 227																				
	White Oak / Ash	3 227																				
Widht 1000 or 1100 mm	White HPL	2 975																				
	Oak / Ash	3 457																				
	Stained Ash	3 768																				
	White Oak / Ash	3 768																				
	<p>Nomono conference in height 900 mm Available lengths: 2400, 2200, 2000, 1800 och 1600 mm.</p> <table border="0" data-bbox="518 1232 1452 1624"> <tr> <td rowspan="4">Width 700, 800 or 900 mm</td> <td>White HPL</td> <td>2 433</td> </tr> <tr> <td>Oak / Ash</td> <td>2 915</td> </tr> <tr> <td>Stained Ash</td> <td>3 227</td> </tr> <tr> <td>White Oak / Ash</td> <td>3 227</td> </tr> <tr> <td rowspan="4">Width 1000 or 1100 mm</td> <td>White HPL</td> <td>2 975</td> </tr> <tr> <td>Oak / Ash</td> <td>3 457</td> </tr> <tr> <td>Stained Ash</td> <td>3 768</td> </tr> <tr> <td>White Oak / Ash</td> <td>3 768</td> </tr> </table>				Width 700, 800 or 900 mm	White HPL	2 433	Oak / Ash	2 915	Stained Ash	3 227	White Oak / Ash	3 227	Width 1000 or 1100 mm	White HPL	2 975	Oak / Ash	3 457	Stained Ash	3 768	White Oak / Ash	3 768
Width 700, 800 or 900 mm	White HPL	2 433																				
	Oak / Ash	2 915																				
	Stained Ash	3 227																				
	White Oak / Ash	3 227																				
Width 1000 or 1100 mm	White HPL	2 975																				
	Oak / Ash	3 457																				
	Stained Ash	3 768																				
	White Oak / Ash	3 768																				
	<p>Nomono conference in height 1060 mm Available lengths: 2400, 2200, 2000, 1800 och 1600 mm.</p> <table border="0" data-bbox="518 1691 1452 2049"> <tr> <td rowspan="4">Widht 700, 800 or 900 mm</td> <td>White HPL</td> <td>2 433</td> </tr> <tr> <td>Oak / Ash</td> <td>2 915</td> </tr> <tr> <td>Stained Ash</td> <td>3 227</td> </tr> <tr> <td>White Oak / Ash</td> <td>3 227</td> </tr> <tr> <td rowspan="4">Width 1000 or 1100 mm</td> <td>White HPL</td> <td>2 975</td> </tr> <tr> <td>Oak / Ash</td> <td>3 457</td> </tr> <tr> <td>Stained Ash</td> <td>3 768</td> </tr> <tr> <td>White Oak / Ash</td> <td>3 768</td> </tr> </table>				Widht 700, 800 or 900 mm	White HPL	2 433	Oak / Ash	2 915	Stained Ash	3 227	White Oak / Ash	3 227	Width 1000 or 1100 mm	White HPL	2 975	Oak / Ash	3 457	Stained Ash	3 768	White Oak / Ash	3 768
Widht 700, 800 or 900 mm	White HPL	2 433																				
	Oak / Ash	2 915																				
	Stained Ash	3 227																				
	White Oak / Ash	3 227																				
Width 1000 or 1100 mm	White HPL	2 975																				
	Oak / Ash	3 457																				
	Stained Ash	3 768																				
	White Oak / Ash	3 768																				


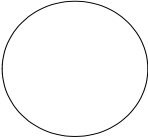
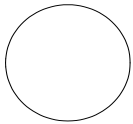
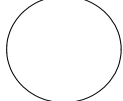
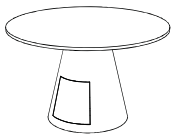

Illustration	Description	Article number	Material	EUR
<p>Tin Design: Morgan Rudberg och Lars Pettersson </p> <p>Tin KONFERENSBORD</p> <ul style="list-style-type: none"> • Desk tops in 19 mm MDF with matching list. • Rectangular table tops: radius 0. • Leg base of perforated, rolled steel sheet. White (31) or black (37). • Legs base with serice hatch for easy handling of cables. • Other RAL colours against quotation • Two desk heights: 73 and 90 cm. • Option: VX cable lid 06470 fits Tin. • For additional product information please see www.horreds.se <p>Material: White HPL = closest NCS S0502-Y Optional HPL: Light grey, Medium grey, Anthracite and Black Linoleum: 4132 Ash, 4154 Burgundy, 4166 Charcoal, 4172 Mauve, 4174 Conifer, 4175 Pebble, 4176 Mushroom, 4177 Vapour, 4179 Smokey Blue, 4184 Olive. Veneer group 1: Oak (03) and Ash (06) Veneer group 2: Black stained Ash (86) / Dark stained Ash (76), White pigmented Oak (30) / White pigmented Ash (10)</p>				
Round table tops:				
<p>1400</p> 	Table top diameter 1400 mm, excluding stand and cable lid	47 31 1603174	White HPL	1 211
		47 39 1603174	Opt. HPL	
		47 88 1603174	Linoleum	1 480
		47 xx 1603174	Veneer 1	1 722
		47 xx 1603174	Veneer 2	1 951
<p>1200</p> 	Table top diameter 1200 mm, excluding stand and cable lid	47 31 1603175	White HPL	491
		47 39 1603175	Opt. HPL	601
		47 88 1603175	Linoleum	695
		47 xx 1603175	Veneer 1	555
		47 xx 1603175	Veneer 2	629
<p>1100</p> 	Table top diameter 1100 mm, excluding stand and cable lid	47 31 1603300	White HPL	491
		47 39 1603300	Opt. HPL	601
		47 88 1603300	Linoleum	695
		47 xx 1603300	Veneer 1	555
		47 xx 1603300	Veneer 2	629
Stands for round tops (excl table top):				
	Tin stand with hatch.. Fits round table top (order separately) Desk heigh 73 cm	47 xx 73R-1	White/black	2 790
	Like above but desk height 90 cm	47 xx 90R-1	White/black	2 907
	Tin stand without hatch.. Fits round table top (order separately) Desk heigh 73 cm	47 xx 73R	White/black	2 479
	Like above but desk height 90 cm	47 xx 90R	White/black	2 596

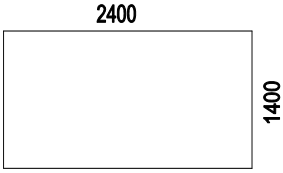

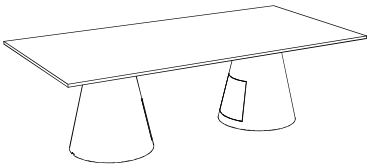
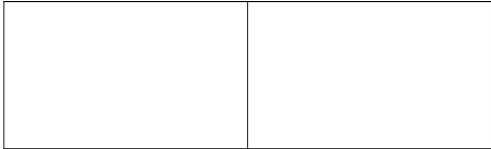
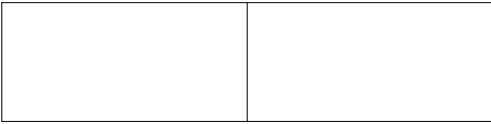
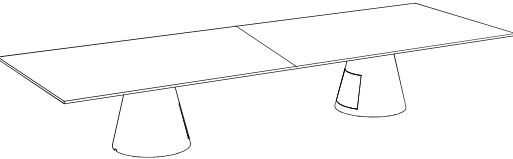
Illustration	Description	Article number	Material	EUR
Rectangular table tops:				
	Table top 2400x1400 mm excluding stand and cable lid	47 31 16007713	White HPL	1 211
		47 39 16007713	Opt. HPL	
		47 88 16007713	Linoleum	1 480
		47 xx 16007713	Veneer 1	1 722
		47 xx 16007713	Veneer 2	1 951
	Table top 2400x1200 mm excluding stand and cable lid	47 31 1603439	White HPL	731
		47 39 1603439	Opt. HPL	789
		47 88 1603439	Linoleum	1 171
		47 xx 1603439	Veneer 1	843
		47 xx 1603439	Veneer 2	957
Stand for rectangular tops (excl table top):				
	Tin stand (x2) with hatches. Fits rectangular tops (order separately) Desk height 73 cm	47 xx 73LLDD-1	White/black	6 066
	Like above but desk height 90 cm	47 xx 90LLDD-1	White/black	6 298
2-pieces rectangular table tops:				
	Table top 4800x1400 (2 pieces) excluding stand and cable lid	47 31 16xxxxx	White HPL	2 536
		47 39 16xxxxx	Opt. HPL	
		47 88 160xxxx	Linoleum	3 073
		47 xx 160xxxx	Veneer 1	3 558
		47 xx 160xxxx	Veneer 2	4 016
	Table top 4800x1200 (2 pieces) excluding stand and cable lid	47 31 1603440	White HPL	1 576
		47 39 1603440	Opt. HPL	1 634
		47 88 1603440	Linoleum	2 456
		47 xx 1603440	Veneer 1	1 799
		47 xx 1603440	Veneer 2	2 028
Stand for 2-piece rectangular tops (excl table top):				
	Tin stand (x2) with hatches. Fits 2-piece rectangular tops (order separately). Desk height 73 cm	47 xx 73LLDD-1	White/black	6 563
	Like above but desk height 90 cm	47 xx 90LLDD-1	White/black	6 796




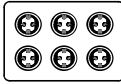
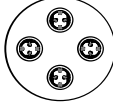


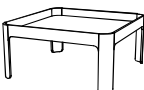
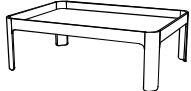
Illustration	Description	Article number	Material	EUR
	<p>MIT Design: Thomas Bernstrand och Stefan Borselius</p> <p>Accessoriet suitable for:</p> <ul style="list-style-type: none"> • VX Konferens • VX Projekt Konferens • Tin 			
	<p>Socket strip single with 4 x power (PM50) 348x108 mm</p>	<p>74 31 08179-4 74 37 08179-4</p>	<p>Vit Svart</p>	<p>259 259</p>
	<p>Socket strip double with 4 x power (PM50) 188x188 mm</p>	<p>74 31 08182-4 74 37 08182-4</p>	<p>White Black</p>	<p>259 259</p>
	<p>Socket strip double with 6 x power (PM50) 268x188 mm</p>	<p>74 31 08182-6 74 37 08182-6</p>	<p>White Black</p>	<p>365 365</p>
	<p>Socket strip round with 4 x power (PM50) ø 245 mm</p>	<p>74 31 08208-4 74 37 08208-4</p>	<p>White Black</p>	<p>258 258</p>
	<p>Socket strip round with 6 x power (PM50) ø 245 mm</p>	<p>74 31 08208-6 74 37 08208-6</p>	<p>White Black</p>	<p>348 348</p>
	<p>Upcharge for alternative powerdot with double USB-A charger (PM51). <u>Note: price for 1 piece</u></p> <p>Upcharge for alternative powerdot with double USB-C PD charger (PM52). <u>Note: price for 1 piece</u></p>			<p>42 55</p>
	<p>Accessories tray for socket strip 08179-4 358x118x100 mm</p>	<p>74 31 08175-4 74 37 08175-4</p>	<p>White Black</p>	<p>544 544</p>
	<p>Accessory tray for socket strip 08124-4 198x198x100 mm</p>	<p>74 31 08180-4 74 37 08180-4</p>	<p>White Black</p>	<p>544 544</p>
	<p>Accessory tray for socket strip 08124-6 278x198x100 mm</p>	<p>74 31 08180-6 74 37 08180-6</p>	<p>White Black</p>	<p>617 617</p>









Illustration	Description	Article number	Material	EUR
Bibox (Also fits Nomono conference)				
	Bi-Box Large, openable cover and cable tray in one, including predrilling cost.	72 10 01-1	White	518
		72 10 01-2	Black	518
	Power Inlay for Bi-box Large: 4xPower, 4xData and 4xUSB.	72 10 04		330
	Bi-Box Small, openable cover and cable tray in one, including predrilling cost.	72 10 00-1	White	285
		72 10 00-2	Black	285
	Power Inlay for Bi-box Small: 3xPower and 2xData.	72 10 02		145
Cable lid (Also fits Tin)				
	VX cable lid, diameter 260 mm. Incl cable tray (black or white) with PD10 power + magic hole), The cable lid is in same material as the table top	34 xxxx 06470		489
	Add.price for alternative powers: PD12 (power, computer, USB-charger)		add. / port	100
	PD13 (power HDMI, USB)		add. / port	136
Powerdot (also fits Tin and Nomono conference)				
	Powerdot cable entry 80 mm 1 x el + 4 x Magic Holes	935 -PD10	Black	66
		935 -PD10W	White	66
	Powerdot cable entry 80 mm 1 x el + 2 x USB-laddare. Adjustable 3 levels.	935 -PD14	Black	148
		935 -PD14W	White	148
	Powerdot cable entry 80 mm. 1 power, 1 USB/A-charger, 1 USB/C, 2 magic holes. Adjustable 2 levels.	935 -PD16	Black	169
		935 -PD16W	White	169
	USB-C chargo 20 W, to 935-PD16	935- PUSBC20	Black	62
	Powerdot cable entry 60 mm. 1 power, 1 USB-laddare.	935 -PM61	Black	103
		935 -PM61W	White	103
	Powerdot cable entry 60 mm. 1 power, 1 USB-IC PD charger	935 -PM62	Black	144
		935 -PM62W	White	144
	Cordless charger ø 60 mm.	935 -QI60	Svart	176
		935 -QI60W	Vit	176
	Cable entry customized	HÅLT.2		121
	Cable pipe in textile. Length1500 mm	29 31 1500	White	119
		29 37 1500	Black	119


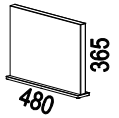
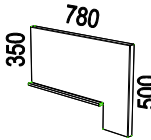
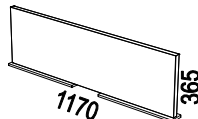
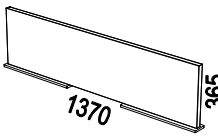


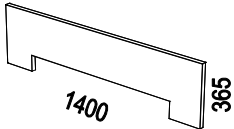
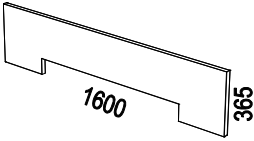
Illustration	Description	Article number	Material	EUR	
<p>Screens</p> <ul style="list-style-type: none"> • Thickness 35 mm, of which 30 mm in sound absorbing material • For other fabrics; please ask for quotation. 					
<p>Price group 1: Camira: Cara, Carlow Gabriel: Event Screen, Hush</p>		<p>Price group 2: Camira: Blazer Lite Gabriel: Soul, Soul Mel, Twist, Twist Mel. Kvadrat: Hint Nevotex: Slope</p>		<p>Price group 3: Camira: Blazer, Main Line Flax Gabriel: Bond, Rondo Kvadrat: Remix, Remix Scr., Floyd Scr. Nevotex: Lido, Lido Trend, Wooly Wide</p>	
<p>Free standing screens</p>					
	<p>Sound absorbing side screen 480x365x35 mm with foot in wood (ø 250mm) Foot available in hard vaxed oiled oak and stained ash.</p>	34 xx 09147-x	PG 1 PG 2 PG 3	371 397 422	
	<p>Sound absorbing side screen 480x365x35 mm Including foot in laquered steel. Choose colour of the foot; white or black.</p>	34 xx 03374-x	PG 1 PG 2 PG 3	292 310 338	
	<p>Sound absorbing side screen 780x350x35 mm. Including foot in laquered steel. Choose colour of the foot; white or black.</p>	34 xx 06360-x	PG 1 PG 2 PG 3	362 398 434	
	<p>Sound absorbing side screen 1170x365x35 mm Including foot in laquered steel. Choose colour of the foot; white or black.</p>	34 xx 04360-x	PG 1 PG 2 PG 3	550 589 643	
	<p>Sound absorbing side screen 1370x365x35 mm Including foot in laquered steel. Choose colour of the foot; white or black.</p>	34 xx 04361-x	PG 1 PG 2 PG 3	566 610 665	
	<p>Pen tray for side screen on foot.</p>	34 31 03357 34 37 03357	White Black	68 68	
<p>Screens for Hub</p>					
	<p>Sound absorbing desk screen 980x265x35 mm, for mounting in Hub. Incl white or black fittings.</p>	34 xx 03375-x	PG 1 PG 2 PG 3	352 377 411	
	<p>Sound absorbing desk screen 1400x365x35 mm, for mounting in Hub. Incl white or black fittings.</p>	34 xx 04358-x	PG 1 PG 2 PG 3	402 428 467	
	<p>Sound absorbing desk screen 1600x365x35 mm, for mounting in Hub. Incl white or black fittings.</p>	34 xx 04359-x	PG 1 PG 2 PG 3	420 451 492	



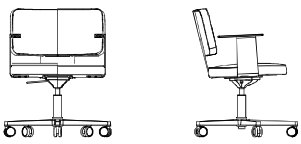

Illustration	Description	Article number	Price group	EUR
Grand Design: Thomas Bernstrand och Stefan Borselius				
	Grand CHAIR <ul style="list-style-type: none"> • Upholstered confere or meeting chair. • Seat of HR-foam on plywood, molded back with metal inserts. • Upcharge for CHMR-foam: € 60. • Arm rest in solid oak / ash or black leather. • Leather armchairs always have leatherclad armrests as standard. • Can also be ordered without armrests. • 5-wing aluminum stand with castors. Powder coated (black and white). • 4-wing aluminum stand with or without castors. Powder coated (black and white). • Lounge model with foot plate and autoreturn. Powder coated (black and white). • Castors with polyurethane roller track, suitable for all floors. • Price for leather chairs in less than 2 pieces; against quotation. • For more product information, see www.horreds.com 			
	<u>Stands:</u> WhiteRAL 9016 (31) Black RAL 9005 (37)	<u>Armrests:</u> Oak (03), Ash (06), Black ash (86), Dark ash (76), White oak (30), White ash (10)		
5-WINGED WITH CASTORS <ul style="list-style-type: none"> • Seat height 44-49 cm • Height of low back 82-87 cm / high back 104-109 cm • Width 67 cm • Height armrests 63-69 cm • Depth 65 cm 				
	Chair with low back and armrests in solid oak / ash (nature/white pigm../dark stained). 5-wing stand, adjustable height 44-49 cm, tilt. Black (37) White (31)	71 xx xx 11M-xxx	PG 1 PG 2 PG 3 PG 4 PG 5 PG 6 PG 7 Leather*	1 309 1 346 1 387 1 428 1 474 1 525 1 597 1 674
	*Note:Leather minimum 2 pcs in same color, always matching leather on armrests			
	Upcharge armrests in black leather	71 xx 97 11M-xxx		41
	Upcharge for interval braked castors	71 xx xx 12M-xxx		27
	Deduction for chair without armrests	71 xx 00 11M-xxx		-116
	Chair with high back and armrests in solid oak / ash (nature/white pigm../dark stained). 5-wing stand, adjustable height 44-49 cm, tilt. Black (37) White (31)	71 xx xx 11H-xxx	PG 1 PG 2 PG 3 PG 4 PG 5 PG 6 PG 7 Leather*	1 504 1 550 1 601 1 653 1 710 1 773 1 864 1 971
	*Note:Leather minimum 2 pcs in same color, always matching leather on armrests			
	Upcharge armrests in black leather	71 xx 97 11H-xxx		41
	Upcharge for interval braked castors	71 xx xx 12H-xxx		27
	Deduction for chair without armrests	71 xx 00 11H-xxx		-116


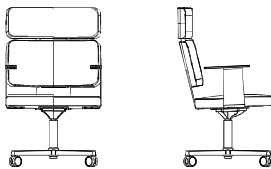
Illustration	Description	Article number	Price group	EUR
<p>4-WING WITH CASTORS</p> <ul style="list-style-type: none"> • Seat height 46 cm • Height of low back 84 cm / high back 106 cm • Width including armrest 60 cm / exclusive armrest 59 cm • Height armrest 67cm • Depth 59 cm 				
	Chair with low back and armrests in solid oak / ash (nature/white pigm../dark stained). 4-wing stand with castors, fixed height 46 cm. Tilt. Black (37) White (31)	71 xx xx 20M-xxx	PG 1 PG 2 PG 3 PG 4 PG 5 PG 6 PG 7 Leather*	1 262 1 298 1 339 1 381 1 427 1 477 1 550 1 626
	*Note:Leather minimum 2 pcs in same color, always matching leather on armrests			
	Upcharge armrests in black leather	71 xx 97 20M-xxx		41
	Upcharge for interval braked castors	71 xx xx 22M-xxx		27
	Deduction for chair without armrests	71 xx 00 20M-xxx		-116
	Chair with high back and armrests in solid oak / ash (nature/white pigm../dark stained). 4-wing stand with castors, fixed height 46 cm. Tilt. Black (37) White (31)	71 xx xx 20H-xxx	PG 1 PG 2 PG 3 PG 4 PG 5 PG 6 PG 7 Leather*	1 458 1 503 1 555 1 606 1 663 1 727 1 818 1 924
	*Note:Leather minimum 2 pcs in same color, always matching leather on armrests			
	Upcharge armrests in black leather	71 xx 97 20H-xxx		41
	Upcharge for interval braked castors	71 xx xx 22H-xxx		27
	Deduction for chair without armrests	71 xx 00 20H-xxx		-116

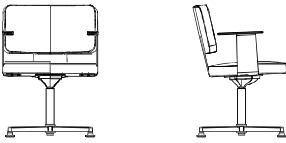
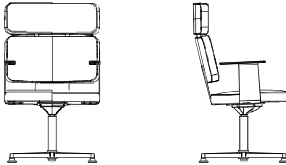

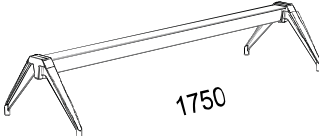
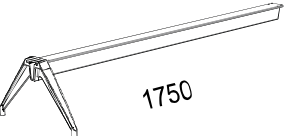
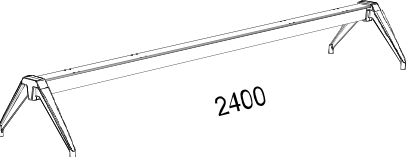
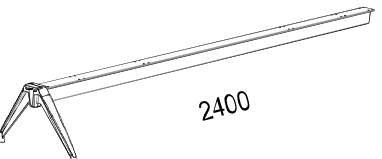
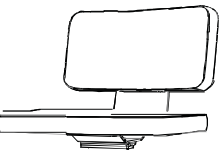


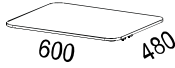
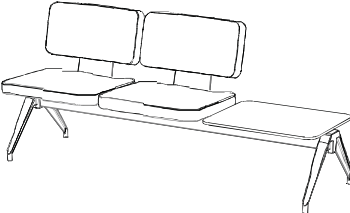
Illustration	Description	Article number	Price group	EUR	
<p>4-WING WITH GLIDES</p> <ul style="list-style-type: none"> • Seat height 46 cm • Height of low back 84 cm / high back 106 cm • Width including armrest 60 cm / exclusive armrest 59 cm • Height armrest 67cm • Depth 59 cm 					
	<p>Chair with low back and armrests in solid oak / ash (nature/white pigm../dark stained). 4-wing stand without castors, fixed height 46 cm. Tilt. Black (37) White (31)</p> <p>Glides are always black.</p> <p>*Note:Leather minimum 2 pcs in same color, always matching leather on armrests</p> <p>Upcharge armrests in black leather</p> <p>Deduction for chair without armrests</p>	<p>71 xx xx 21M-xxx</p> <p>71 xx 00 21M-xxx</p>	<p>PG 1</p> <p>PG 2</p> <p>PG 3</p> <p>PG 4</p> <p>PG 5</p> <p>PG 6</p> <p>PG 7</p> <p>Leather*</p>	<p>1 233</p> <p>1 270</p> <p>1 311</p> <p>1 352</p> <p>1 398</p> <p>1 449</p> <p>1 521</p> <p>1 598</p> <p>41</p> <p>-116</p>	
		<p>Chair with high back and armrests in solid oak / ash (nature/white pigm../dark stained). 4-wing stand without castors, fixed height 46 cm. Tilt. Black (37) White (31)</p> <p>Glides are always black.</p> <p>*Note:Leather minimum 2 pcs in same color, always matching leather on armrests</p> <p>Upcharge armrests in black leather</p> <p>Deduction for chair without armrests</p>	<p>71 xx xx 21H-xxx</p> <p>71 xx 00 21H-xxx</p>	<p>PG 1</p> <p>PG 2</p> <p>PG 3</p> <p>PG 4</p> <p>PG 5</p> <p>PG 6</p> <p>PG 7</p> <p>Leather*</p>	<p>1 429</p> <p>1 475</p> <p>1 526</p> <p>1 578</p> <p>1 635</p> <p>1 699</p> <p>1 789</p> <p>1 896</p> <p>41</p> <p>-116</p>

Illustration	Description	Article number	Price group	EUR
Grand Balk Design: Thomas Bernstrand och Stefan Borselius				
	<p>GRAND BALK Sofa</p> <ul style="list-style-type: none"> Fully upholstered buildable beam sofa in seat height 46 cm. Beam and legs in recycled aluminum, powder coated. Seat module of molded HR raom on plywood, molded back with metal insert. CMHR foam for an additional € 60. Arms upport in solid oak / ash. Black leather for an additional € 41. Armchairs in leather always have leather-covered handles in same colour. For mor product information see www.horreds.se 			
	Beam, freestanding, for 3 modules Length 1750mm	71 37 1750	Black	1 043
	Beam, for coupling, for 3 modules Lengt 1750mm, with 1 leg. <i>To be used together with freestanding beam</i>	71 37 1750K	Black	924
	Beam, freestanding, for 4 modules Length 2400mm	71 37 2400	Black	1 215
	Beam, for coupling, for 4 modules Lengt 2400mm, with 1 leg. <i>To be used together with freestanding beam</i>	71 37 2400K	Black	1 096
	Seating module with black back plate. Incl. clamp to beam. • Width 59cm • Depth 59cm • Back height 82cm (above floorv) *NB:Leather minimum 2 pcs in same colour,	71 xx 00M-x	PG 1 PG 2 PG 3 PG 4 PG 5 PG 6 PG 7 Leather*	788 828 868 907 953 1 014 1 106 1 182
	Upcharge for armsupport right / left Note: Price per piece Black bracket with armsupport in solid oak/ash (clear coated or stained in standard stains.	71 xx37 08129H 71 xx37 08129V	black/veneer black/veneer	58 58
	Table top 480x300mm, incl clamp, corresponds to 0,5 module. With edging and chamfered edge.	71 xx37 -300	Veneer Laminate Linoleum	206 206 206
	Table top 480x600mm, incl clamp, corresponds to 1 module. With edging and chamfered edge.	71 xx37 -600	Veneer Laminate Linoleum	355 355 355

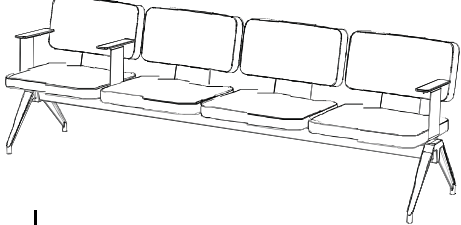
	Electricity / charging in table top - required 2 pcs / table.					
	1 x Power	935	PM50	Black	63	
	2x USB-A charger	935	PM51	Black	1 033	
	2x USB-C charger	935	PM52	Black	144	
	Cable sock in textile 1500mm	29	37	1500	Black	119

Price example 1:



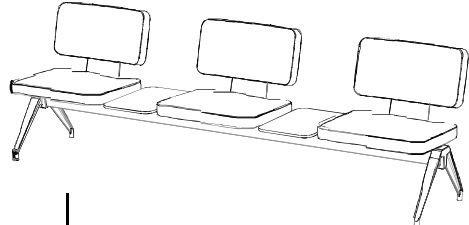
Freestanding beam for 3 modules	art nr 71 37 1750	Material	Pieces	Price/pce	Total
Seating module	art 71 37 00M-x	Black	1	1 043	1 043
Table top 480x600 mm, incl clamp	art 71 06 37-600	PG 1	2	788	1 576
		Ash	1	355	355
					2 974

Price example 2:



Freestanding beam for 4 modules	art nr 71 37 2400	Material	Pieces	Price/pce	Total
Seating module	art 71 37 00M-x	Black	1	1 215	1 215
Armrest right	art 71 37 06 08129H	PG 1	4	788	3 152
Armrest left	art 71 37 06 08129V	Black/ash	1	58	58
		Black/ash	2	58	116
					4 367

Price example 3:



Freestanding beam for 4 modules	art nr 71 37 2400	Material	Pieces	Price/pce	Total
Seating module	art 71 37 00M-x	Svart	1	1 215	1 215
Table top 480x300 mm, incl clamp	art 71 06 37-300	Tyg PG 1	3	788	2 364
		Ask	2	206	412
					3 991

Corner setups / other lengths? Please contact us for a quote.

Glove Design: Fredrik Mattson**Glove Medium and High**

- Upholstered conference/meeting chair in high or medium design.
- Molded cold foam (HR) with metal frame. Upcharge for CMHR foam; € 36.
- Castors with polyurethane roller conveyor, suitable for all floors.
- If stand in a colour other than standard is desired; contact us for a quote.
- For fabric selection; see Fabrics - Price Groups. If other fabric desired; contact us for a quote.
- New: channel-sewn upholstery bolster as an option in price group 1-7 excl. artificial leather.
- 6 different stands:



5-wing aluminum stand in black alt. white powder coating or polished aluminum.
Tilt, adjustable height 43-53 cm.



4-wing aluminum stand with wheels castors and tilt. Black alt. white powder coating or polished aluminum.



4-wing aluminum stand with sliding feet and tilt. Black alt. white powder coating or polished aluminum.



5-wing steel stand in black powder coating.
Tilt, fixed height 45 cm.
43-52 cm. Option: adjustable height 43-52 cm.



4-legged steel stand in black alt. white powder coating or chrome.



4-legged wooden stand in oak alt. ash.

Glove Bolster Cover

Do you have a Glove that needs to be renewed?

Glove Bolster Cover is now available, a cover for Glove High and Medium.

The bolster cover not only gives Glove a new life, but also a new character.

A figure-hugging, looser and slightly more comfortable sitting experience.



- For more product information, see www.horreds.se


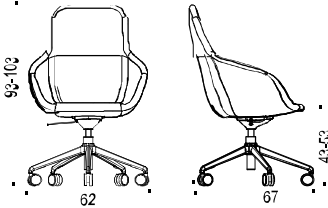
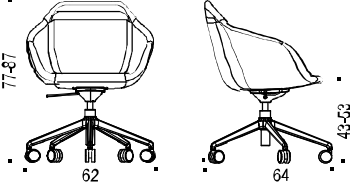
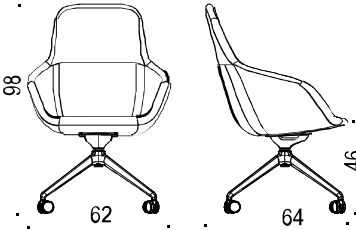
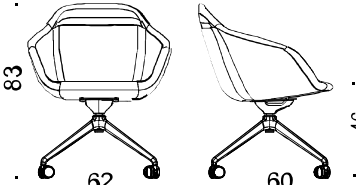
Illustration	Description	Article number	Price group	EUR
Glove Design: Fredrik Mattson				
Glove CHAIR				
	<p>Chair, high back. 5-wing aluminum base, with tilt, rotatable, adjustable height 43-53 cm. Black base (37).</p> <p>*NB: Leather min. 2 chairs in same colour <i>Upcharge for Bolster upholstery pg 1-7**</i> <i>Upcharge for interval braked castors</i> <i>Upcharge polished alu (13) alt. white (31)</i> <i>Upcharge for swing with adj. hardness</i></p>	<p>51 37 51H01-xxx</p> <p>51 xx 51H0B-xxx</p> <p>51 xx 51H11-xxx</p> <p>51 xx 51H01-xxx</p> <p>51 xx 52H01-xxx</p>	<p>PG 1 PG 2 PG 3 PG 4 PG 5 PG 6 PG 7 Leather*</p>	<p>1 058 1 107 1 162 1 217 1 279 1 347 1 445 1 501 139 27 55 96</p>
	<p>Chair, medium back. 5-wing aluminum stand, with tilt, rotatable, adjustable height 43-53 cm. Blak base (37).</p> <p>*NB: Leather min. 2 chairs in same colour <i>Upcharge for Bolster upholstery pg 1-7**</i> <i>Upcharge for interval braked castors</i> <i>Upcharge polished alu (13) alt. white (31)</i> <i>Upcharge for swing with adj. hardness</i></p>	<p>51 37 51M01-xxx</p> <p>51 xx 51M0B-xxx</p> <p>51 xx 51M11-xxx</p> <p>51 xx 51M01-xxx</p> <p>51 xx 52M01-xxx</p>	<p>PG 1 PG 2 PG 3 PG 4 PG 5 PG 6 PG 7 Leather*</p>	<p>979 1 021 1 069 1 117 1 171 1 230 1 314 1 440 139 27 55 96</p>
	<p>Chair, high back. 4-winged aluminium base with castors and tilt, turnable. Blak base (37).</p> <p>*NB: Leather min. 2 chairs in same colour <i>Upcharge for Bolster upholstery pg 1-7**</i> <i>Upcharge polished alu (13) alt. white (31)</i></p>	<p>51 37 31H01-xxx</p> <p>51 xx 31H0B-xxx</p> <p>51 xx 31H01-xxx</p>	<p>PG 1 PG 2 PG 3 PG 4 PG 5 PG 6 PG 7 Leather*</p>	<p>1 013 1 062 1 117 1 172 1 234 1 302 1 400 1 456 139 42</p>
	<p>Chair, medium back. 4-winged aluminium base with castors and tilt, turnable. Blak base (37).</p> <p>*NB: Leather min. 2 chairs in same colour <i>Upcharge for Bolster upholstery pg 1-7**</i> <i>Upcharge polished alu (13) alt. white (31)</i></p>	<p>51 37 31M01-xxx</p> <p>51 xx 31M0B-xxx</p> <p>51 xx 31M01-xxx</p>	<p>PG 1 PG 2 PG 3 PG 4 PG 5 PG 6 PG 7 Leather*</p>	<p>934 976 1 024 1 072 1 125 1 184 1 269 1 395 139 42</p>
**= PG 1-7 excluding artificial leathers				

Illustration	Description	Article number	Price group	EUR
	<p>Chair, high back 4-winged aluminium base with glides and tilt, turnable. Base black (37)</p> <p><i>*NB: Leather min. 2 chairs in same colour</i> <i>Upcharge for Bolster upholstery pg 1-7**</i> <i>Upcharge polished alu (13) alt. white (31)</i> <i>Upcharge for felt glides</i> <i>Upcharge for auto-return</i></p>	<p>51 37 32H01-xxx</p> <p>51 xx 32H0B-xxx</p> <p>51 xx 32H01-xxx</p> <p>51 xx 32HF1-xxx</p> <p>51 xx 33H01-xxx</p>	<p>PG 1 PG 2 PG 3 PG 4 PG 5 PG 6 PG 7 Leather*</p>	<p>985 1 034 1 089 1 144 1 206 1 274 1 372 1 428 139 42 11 46</p>
	<p>Chair, medium back 4-winged aluminium base with glides and tilt, turnable. Base black (37)</p> <p><i>*NB: Leather min. 2 chairs in same colour</i> <i>Upcharge for Bolster upholstery pg 1-7**</i> <i>Upcharge polished alu (13) alt. white (31)</i> <i>Upcharge for felt glides</i> <i>Upcharge for auto-return</i></p>	<p>51 37 32M01-xxx</p> <p>51 xx 32M0B-xxx</p> <p>51 xx 32M01-xxx</p> <p>51 xx 32MF1-xxx</p> <p>51 xx 33M01-xxx</p>	<p>PG 1 PG 2 PG 3 PG 4 PG 5 PG 6 PG 7 Leather*</p>	<p>906 949 997 1 044 1 098 1 157 1 241 1 368 139 42 11 46</p>
	<p>Chair, high back. 5-winged black (37) steel base with castors and tilt, rotatable, fixed height 45 cm. Other colours/chrome: contact us for quotation</p> <p><i>*NB: Leather min. 2 chairs in same colour</i> <i>Upcharge for Bolster upholstery pg 1-7**</i> <i>Upcharge for interval braked castors</i> <i>Upcharge for tilt and adj. Height 43-52 cm</i> <i>Upcharge for swing and adjustable height</i></p>	<p>51 37 44H01-xxx</p> <p>51 xx 44H0B-xxx</p> <p>51 xx 44H11.xxx</p> <p>51 xx 45H01-xxx</p> <p>51 xx 41H01-xxx</p>	<p>PG 1 PG 2 PG 3 PG 4 PG 5 PG 6 PG 7 Leather*</p>	<p>1 190 1 239 1 294 1 349 1 411 1 479 1 577 1 633 139 27 28 96</p>
	<p>Chair, high back. 5-winged black (37) steel base with castors and tilt, rotatable, fixed height 45 cm. Other colours/chrome: contact us for quotation</p> <p><i>*NB: Leather min. 2 chairs in same colour</i> <i>Upcharge for Bolster upholstery pg 1-7**</i> <i>Upcharge for interval braked castors</i> <i>Upcharge for tilt and adj. Height 43-52 cm</i> <i>Upcharge for swing and adjustable height</i></p>	<p>51 37 44M01-xxx</p> <p>51 xx 44M0B-xxx</p> <p>51 xx 44M11.xxx</p> <p>51 xx 45M01-xxx</p> <p>51 xx 41M01-xxx</p>	<p>PG 1 PG 2 PG 3 PG 4 PG 5 PG 6 PG 7 Leather*</p>	<p>1 111 1 153 1 201 1 249 1 302 1 361 1 446 1 572 139 27 28 96</p>
**= PG 1-7 excluding artificial leathers				

Illustration	Description	Article number	Price group	EUR
	<p>Chair, high back, 4 metal legs Base white (31) or black (37).</p> <p><i>*NB: Leather min. 2 chairs in same colour Upcharge for Bolster upholstery pg 1-7** Upcharge for base in chrome (13)</i></p>	<p>51 xx 20H01-xxx</p> <p>51 xx 20H0B-xxx</p> <p>51 13 20H01-xxx</p>	<p>PG 1 PG 2 PG 3 PG 4 PG 5 PG 6 PG 7 Leather*</p>	<p>796 845 900 955 1 017 1 085 1 182 1 238 139 36</p>
	<p>Chair, medium back, 4 metal legs Base white (31) or black (37).</p> <p><i>*NB: Leather min. 2 chairs in same colour Upcharge for Bolster upholstery pg 1-7** Upcharge for base in chrome (13)</i></p>	<p>51 xx 20M01-xxx</p> <p>51 xx 20M0B-xxx</p> <p>51 13 20M01-xxx</p>	<p>PG 1 PG 2 PG 3 PG 4 PG 5 PG 6 PG 7 Leather*</p>	<p>717 759 807 854 908 967 1 051 1 178 139 36</p>
	<p>Chair, high back 4 wooden legs in oak (03) or ash (06).</p> <p><i>*NB: Leather min. 2 chairs in same colour Upcharge for Bolster upholstery pg 1-7** Upcharge for stained legs; white oak (30), black ash (86), white ash (10), dark ash (76) Burgundy (C8),ash Conifer (D3) and ash Smokey Blue (D4).</i></p>	<p>51 xx 15H01-xxx</p> <p>51 xx 15H0B-xxx</p> <p>51 xx 15H01-xxx</p>	<p>PG 1 PG 2 PG 3 PG 4 PG 5 PG 6 PG 7 Leather*</p>	<p>910 958 1 013 1 069 1 130 1 198 1 296 1 352 139 76</p>
	<p>Chair, medium back 4 wooden legs in oak (03) or ash (06).</p> <p><i>*NB: Leather min. 2 chairs in same colour Upcharge for Bolster upholstery pg 1-7** Upcharge for stained legs; white oak (30), black ash (86), white ash (10), dark ash (76) Burgundy (C8),ash Conifer (D3) and ash Smokey Blue (D4).</i></p>	<p>51 xx 15M01-xxx</p> <p>51 xx 15M0B-xxx</p> <p>51 xx 15M01-xxx</p>	<p>PG 1 PG 2 PG 3 PG 4 PG 5 PG 6 PG 7 Leather*</p>	<p>842 884 932 980 1 033 1 092 1 177 1 303 139 76</p>
**= PG 1-7 excluding artificial leathers				



Illustration	Description	Article number	Price group	EUR
Glove Bolster Cover Design: Fredrik Mattson				
<p style="text-align: center;">Glove BOLSTER COVER</p> <ul style="list-style-type: none"> • Dressing fabric for Glove High and Medium. • Channel-sewn upholstery in fabrics from price group 1-7 with exception of artificial leather. • With zippers for easy mounting on existing chair. • For more product information see www.horreds.se 				
	<p>Dressing fabric for Glove High with steel stand Dressing fabric for Glove High with wooden stand</p> <p><i>Note: PG 1-7 excluding artificial leathers</i></p>	<p>51 BHS -xxx 51 BHT -xxx</p>	<p>PG 1 PG 2 PG 3 PG 4 PG 5 PG 6 PG 7</p>	<p>365 415 465 516 574 651 767</p>
	<p>Dressing fabric for Glove Medium with steel stand Dressing fabric for Glove Medium with wooden stand</p> <p><i>Note: PG 1-7 excluding artificial leathers</i></p>	<p>51 BMS -xxx 51 BMT -xxx</p>	<p>PG 1 PG 2 PG 3 PG 4 PG 5 PG 6 PG 7</p>	<p>342 388 433 479 532 602 707</p>


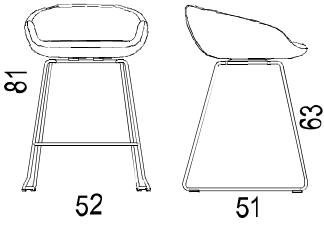
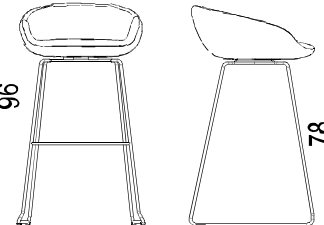


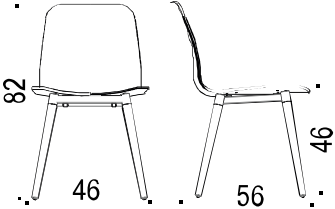
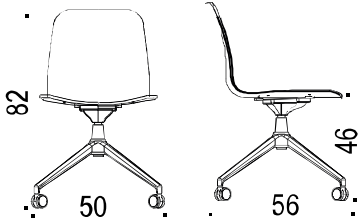
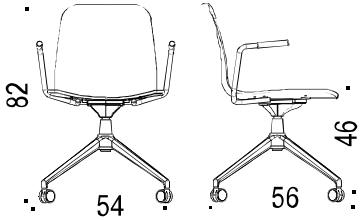
Illustration	Description	Article number	Price group	EUR
<p>Glove Bar Design: Fredrik Mattson</p>				
	<p>Glove Bar</p> <ul style="list-style-type: none"> • Fully upholstered seat of molded cold foam (HR) with metal frame.. • Stand of 12 mm wire. • Upcharge for CMHR-skum: € 30. • For more product information see www.horreds.se <p style="text-align: center;"><u>Stand::</u> Black RAL 9005 smooth gl.30 (37) (Other colours agains quotation)</p>			
	<p>Bar stool with black stand, seating height 630 mm</p> <p>*NB: Leather min.2 pcs in same colour</p> <p><i>Upcharge for felt glides</i></p>	<p>51 37 60B01-xxx</p> <p><i>51 37</i></p>	<p>PG 1 PG 2 PG 3 PG 4 PG 5 PG 6 PG 7 Leather*</p>	<p>575 599 626 654 684 718 766 1 009 10</p>
	<p>Bar stool with black stand, seating height 780 mm</p> <p>*NB: Leather min.2 pcs in same colour</p> <p><i>Upcharge for felt glides</i></p>	<p>51 37 61B01-xxx</p> <p><i>51 37 61BF1-xxx</i></p>	<p>PG 1 PG 2 PG 3 PG 4 PG 5 PG 6 PG 7 Leather*</p>	<p>628 653 680 707 738 772 820 1 063 10</p>

Illustration	Description	Article number	Price group	EUR
Cuba Design: Horreds				
<div style="display: flex; justify-content: space-between; align-items: flex-start;"> <div style="width: 30%;">  </div> <div style="width: 40%; text-align: center;"> <h3>Cuba stol</h3> <ul style="list-style-type: none"> • Fully upholstered seat of molded plywood with cold foam.. • Wooden legs in clear coated solid oak / ash are standard stained against upcharge: <ol style="list-style-type: none"> 1) Oak; white pigmented 2) Ash; white pigmented, black stained, dark stained Burgundy stain, Conifer stain and Smokey Blue stain. • 4-wing black aluminum stand (RAL9005) with/whitout castors. • For more product information see www.horreds.se </div> <div style="width: 25%; text-align: center;">  </div> </div>				
	<p>Chair Wooden legs in solid oak / ash, clear coated. Seating height 46cm Frame in metal, black RAL 9005 Oak (03), Ash (06)</p> <p>*NB: Leather min.4 pcs in same colour <i>Upcharge for stained legs</i></p>	<p>34 xx 1037-xxx</p> <p>34 xx 1037-xxx</p>	<p>PG 1 PG 2 PG 3 PG 4 PG 5 PG 6 PG 7 Leather*</p>	<p>467 486 508 530 554 581 620 707 72</p>
	<p>Chair 4-wing aluminum stand, with castors, fixed height, tilt, swivel. Seating height 46cm Black RAL 9005</p> <p>*NB: Leather min.4 pcs in same colour <i>Upcharge for height adj. 42-52 cm</i> <i>Upcharge for stained legs</i></p>	<p>34 xx 30-xxx</p> <p>34 xx 34-xxx 34 30l-xxx</p>	<p>PG 1 PG 2 PG 3 PG 4 PG 5 PG 6 PG 7 Leather*</p>	<p>552 572 595 618 643 671 712 803 25 27</p>
	<p>Armchair 4-wing aluminum stand, with castors, fixed height, tilt, swivel. Seating height 46cm Black RAL 9005</p> <p>*NB: Leather min.4 pcs in same colour <i>Upcharge for height adj. 42-52 cm</i> <i>Upcharge for interval braked wheels</i></p>	<p>34 xx 31-xxx</p> <p>34 xx 35-xxx 34 xx 31l-xxx</p>	<p>PG 1 PG 2 PG 3 PG 4 PG 5 PG 6 PG 7 Leather*</p>	<p>662 683 705 728 754 782 823 914 25 27</p>

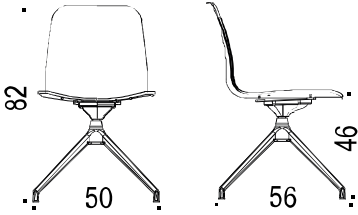
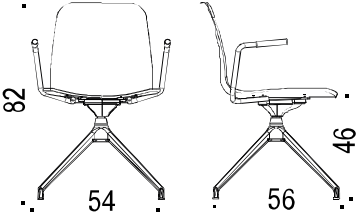

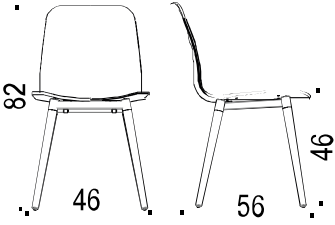
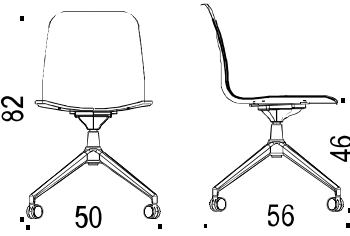
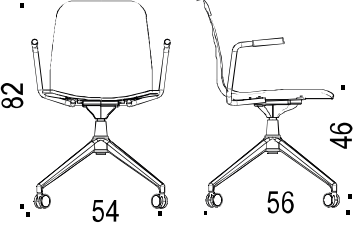
	<p>Chair 4-wing aluminum stand, with glides, fixed height, tilt, swivel. Seating height 46cm <i>Black RAL 9005</i></p> <p><i>*NB: Leather min.4 pcs in same colour</i> <i>Upcharge for felt glides</i></p>	<p>34 xx 32-xxx</p> <p>34 xx 32F-xxx</p>	<p>PG 1 PG 2 PG 3 PG 4 PG 5 PG 6 PG 7 Leather*</p>	<p>552 572 595 618 643 671 712 803 11</p>
	<p>Armchair 4-wing aluminum stand, with glides, fixed height, tilt, swivel. Seating height 46cm <i>Black RAL 9005</i></p> <p><i>*NB: Leather min.4 pcs in same colour</i> <i>Upcharge for felt glides</i></p>	<p>34 xx 33-xxx</p> <p>34 xx 33F-xxx</p>	<p>PG 1 PG 2 PG 3 PG 4 PG 5 PG 6 PG 7 Leather*</p>	<p>662 683 705 728 754 782 823 914 11</p>

Illustration	Description	Article number	Price group
Cuba Design: Horreds			
	<p>Cuba, quilted</p> <ul style="list-style-type: none"> Fully upholstered seat of molded plywood with cold foam. Quilted upholstery which is replaceable. Wooden legs in clear coated solid oak and ash. Stained legs against upcharge: <ol style="list-style-type: none"> Oak; white pigmented Ash; white pigmented, black stained, dark stained Burgundy stain, Conifer stain and Smokey Blue stain. 4-wing black (RAL 9005) aluminum stand, with/without castors. Other colours on request. For more product information see www.horreds.se 		
	<p>Chair with quilted upholstery. Wooden legs in solid oak/ash, clear coated. Seating height 46cm Frame in metal black RAL 9005 Oak (03), Ash (06)</p> <p>*NB: Leather min.4 pcs in same colour</p> <p><i>Upcharge for stained legs</i></p>	<p>34Q xx 1037-xxx</p> <p>34Q xx 1037-xxx</p>	<p>PG 1 PG 2 PG 3 PG 4 PG 5 PG 6 PG 7 Leather*</p>
	<p>Chair with quilted upholstery. 4-wing aluminum stand with castors. Fixed height, tilt, rotation. Seating height 46cm Black RAL 9005</p> <p>*NB: Leather min.4 pcs in same colour</p> <p><i>Upcharge for height adj. 42-52cm</i> <i>Upcharge for interval braked castors</i></p>	<p>34Q xx 30-xxx</p> <p>34Q xx 34-xxx 34Q 301-xxx</p>	<p>PG 1 PG 2 PG 3 PG 4 PG 5 PG 6 PG 7 Leather*</p>
	<p>Armchair with quilted upholstery. 4-wing aluminum stand with castors. Fixed height, tilt, rotation. Seating height 46cm Black RAL 9005</p> <p>*NB: Leather min.4 pcs in same colour</p> <p><i>Upcharge for height adj. 42-52cm</i> <i>Upcharge for interval braked castors</i></p>	<p>34Q xx 31-xxx</p> <p>34Q xx 35-xxx 34Q xx 311-xxx</p>	<p>PG 1 PG 2 PG 3 PG 4 PG 5 PG 6 PG 7 Leather*</p>

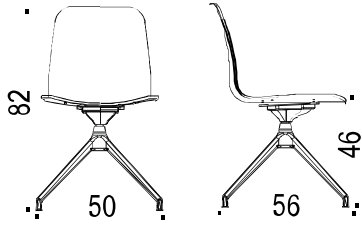
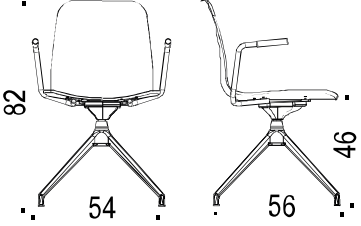


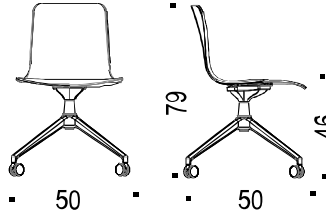
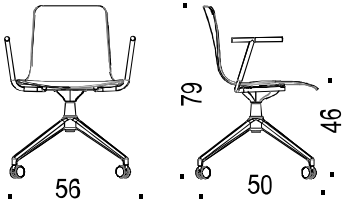
	<p>Chair with quilted upholstery 4-wing aluminum stand with sliding feet, fixed height, tilt, rotation. Seating height 46cm <i>Black RAL 9005</i></p> <p><i>*NB: Leather min.4 pcs in same colour</i> <i>Upcharge for sliding feet with felt</i></p>	<p>34Q xx 32-xxx</p> <p>34Q xx 32F-xxx</p>	<p>PG 1 PG 2 PG 3 PG 4 PG 5 PG 6 PG 7 Leather*</p>
	<p>Armchair with quilted upholstery 4-wing aluminum stand with sliding feet, fixed height, tilt, rotation. Seating height 46cm <i>Black RAL 9005</i></p> <p><i>*NB: Leather min.4 pcs in same colour</i> <i>Upcharge for sliding feet with felt</i></p>	<p>34Q xx 33-xxx</p> <p>34Q xx 33F-xxx</p>	<p>PG 1 PG 2 PG 3 PG 4 PG 5 PG 6 PG 7 Leather*</p>

Illustration	Description	Article number	Price group	EUR	Pris
Base Design: Anderssen & Voll					
<div style="display: flex; justify-content: space-between; align-items: flex-start;"> <div style="width: 25%;">  </div> <div style="width: 50%;"> <h3 style="margin: 0;">Base 4-winged with castors</h3> <ul style="list-style-type: none"> • Chair/arm chair with pressed seat shell. • Fully upholstered. Padding of cold foam (CMHR). • 4-winged aluminum base with castors and tilt function. • Castors with polyurethane roller conveyor, suitable for all floors. • Armrests can be retrofitted / disassembled. • Price for leather chairs in less than 4 pieces: against quotation • Thicker upholstery as option. • For more information, see www.horreds.se <p style="text-align: center;"><u>Colours stands (xx):</u> 37 Black (RAL 9005) 13 Polished (against upcharge) NB: Model A60 only. <i>(Aother RAL colours against quotation)</i></p> </div> <div style="width: 20%; text-align: right;">  </div> </div>					
	<p>Chair, 4-winged black aluminum stand with castors, fixed height, tilt, fully upholstered</p> <p><i>*Note:Leather min 4 pcs in same colour</i></p> <p><i>Upcharge for thicker upholstery</i></p> <p><i>Upcharge for polished stand</i></p>	<p>65 A60 xx 97-xxx</p> <p>65 A60 xx 97-xxx</p> <p>65 A60 xx 97-xxx</p> <p>65 A60 xx 97-xxx</p> <p>65 A60 xx 97-xxx</p> <p>65 A60 xx 97-xxx</p> <p>65 A60 xx 97-xxx</p> <p>65 A60 xx 97-xxx</p> <p>65 A60 xx 97-xxx</p> <p>65 B61 xx 97-xxx</p> <p>65 A60 13 97-xxx</p>	<p>PG 1</p> <p>PG 2</p> <p>PG 3</p> <p>PG 4</p> <p>PG 5</p> <p>PG 6</p> <p>PG 7</p> <p>Leather*</p>	<p>679</p> <p>703</p> <p>730</p> <p>757</p> <p>787</p> <p>821</p> <p>868</p> <p>976</p> <p>59</p> <p>44</p>	
	<p>Arm chair, 4-winged black aluminum stand with castors, fixed height, tilt, fully upholstered</p> <p><i>*Note:Leather min 4 pcs in same colour</i></p> <p><i>Upcharge for thicker upholstery</i></p> <p><i>Upcharge for polished stand</i></p>	<p>65 A61 xx 97-xxx</p> <p>65 A61 xx 97-xxx</p> <p>65 A61 xx 97-xxx</p> <p>65 A61 xx 97-xxx</p> <p>65 A61 xx 97-xxx</p> <p>65 A61 xx 97-xxx</p> <p>65 A61 xx 97-xxx</p> <p>65 A61 xx 97-xxx</p> <p>65 A61 xx 97-xxx</p> <p>65 B61 xx 97-xxx</p>	<p>PG 1</p> <p>PG 2</p> <p>PG 3</p> <p>PG 4</p> <p>PG 5</p> <p>PG 6</p> <p>PG 7</p> <p>Leather*</p>	<p>959</p> <p>983</p> <p>1 010</p> <p>1 037</p> <p>1 067</p> <p>1 100</p> <p>1 148</p> <p>1 256</p> <p>59</p>	

Base Design: Anderssen & Voll



Base med 4-vingat benstativ



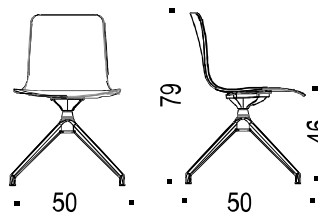
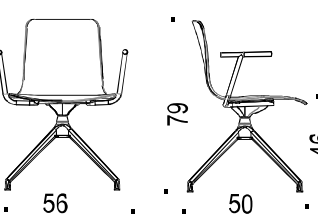
- Chair/arm chair with pressed seat shell.
- Fully upholstered. Padding of cold foam (CMHR).
 - 4-winged aluminum base with tilt function.
 - Armrests can be retrofitted / disassembled.
 - Price for leather chairs in less than 4 pieces: against quotation
 - Thicker upholstery as option.
 - For more information, see www.horreds.se

Colours stands (xx):

37 Black (RAL 9005)

13 Polished (against upcharge) NB: Model A62 only.

(Aother RAL colours against quotation)

	<p>Chair, 4-winged black aluminum stand without castors, fixed height, tilt, fully upholstered</p> <p><i>*Note:Leather min 4 pcs in same colour</i></p> <p><i>Upcharge for thicker upholstery</i></p> <p><i>Upcharge for polished stand</i></p> <p><i>Upcharge for sliding feet with felt</i></p>	<p>65 A62 xx 97-xxx</p> <p>65 A62 xx 97-xxx</p> <p>65 A62 xx 97-xxx</p> <p>65 A62 xx 97-xxx</p> <p>65 A62 xx 97-xxx</p> <p>65 A62 xx 97-xxx</p> <p>65 A62 xx 97-xxx</p> <p>65 A62 xx 97-xxx</p> <p>65 B62 xx 97-xxx</p> <p>65 A62 13 97-xxx</p>	<p>PG 1</p> <p>PG 2</p> <p>PG 3</p> <p>PG 4</p> <p>PG 5</p> <p>PG 6</p> <p>PG 7</p> <p>Leather*</p>	<p>679</p> <p>703</p> <p>730</p> <p>757</p> <p>787</p> <p>821</p> <p>868</p> <p>976</p> <p>59</p> <p>44</p> <p>12</p>
	<p>Arm chair, 4-winged black aluminum stand without castors, fixed height, tilt, fully upholstered</p> <p><i>*Note:Leather min 4 pcs in same colour</i></p> <p><i>Upcharge for thicker upholstery</i></p> <p><i>Upcharge for sliding feet with felt</i></p> <p><i>Upcharge for polished stand</i></p>	<p>65 A63 xx 97-xxx</p> <p>65 A63 xx 97-xxx</p> <p>65 A63 xx 97-xxx</p> <p>65 A63 xx 97-xxx</p> <p>65 A63 xx 97-xxx</p> <p>65 A63 xx 97-xxx</p> <p>65 A63 xx 97-xxx</p> <p>65 A63 xx 97-xxx</p> <p>65 B63 xx 97-xxx</p>	<p>PG 1</p> <p>PG 2</p> <p>PG 3</p> <p>PG 4</p> <p>PG 5</p> <p>PG 6</p> <p>PG 7</p> <p>Leather*</p>	<p>959</p> <p>983</p> <p>1 010</p> <p>1 037</p> <p>1 067</p> <p>1 100</p> <p>1 148</p> <p>1 256</p> <p>59</p> <p>12</p>

Base Design: Anderssen & Voll



Base med 5-vingat hjulstativ

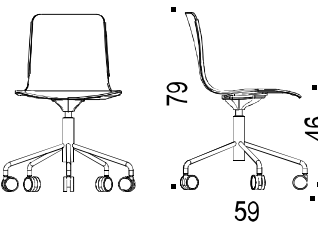
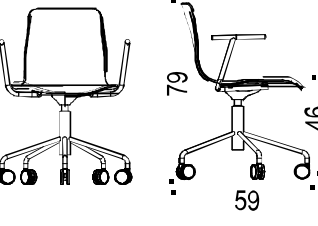


- Chair / armchair with pressed seat shell
- Fully upholstered. Padding of cold foam (CMHR).
- 5-star swivel with castors, 2 different models.
- Castors with polyurethane roller conveyor, suitable for all floors
- Armrest can be retrofitted / disassembled
- Minimum number of pieces for leather: 4 chairs.
- For more information, see www.horreds.se

Kulör stativ:

37 Svart Ral 9005

(Andra färger mot offert)

	<p>Chair, 5-wing black stand with castors, fixed height, tilt, fully upholstered.</p> <p>*NB: Leather min. 4 chairs in same colour</p> <p><i>Upcharge for adjustable height 44-53 cm</i></p> <p><i>Upcharge for interval braked castors</i></p> <p><i>Upcharge for thicker upholstery</i></p>	<p>65 A50 37 97-xxx</p> <p>65 A50 37 97-xxx</p> <p>65 A50 37 97-xxx</p> <p>65 A50 37 97-xxx</p> <p>65 A50 37 97-xxx</p> <p>65 A50 37 97-xxx</p> <p>65 A50 37 97-xxx</p> <p>65 A50 37 97-xxx</p> <p>65 A52 37 97-xxx</p> <p>65 xxx 37 97-xxx</p> <p>65 B50 37 97-xxx</p>	<p>PG 1</p> <p>PG 2</p> <p>PG 3</p> <p>PG 4</p> <p>PG 5</p> <p>PG 6</p> <p>PG 7</p> <p>Leather*</p>	<p>794</p> <p>818</p> <p>845</p> <p>872</p> <p>902</p> <p>935</p> <p>983</p> <p>1 091</p> <p>29</p> <p>28</p> <p>59</p>
	<p>Armchair, 5-wing black stand with fixed height, tilt, fully upholstered.</p> <p>*NB: Leather min. 4 chairs in same colour</p> <p><i>Upcharge for adjustable height 44-53 cm</i></p> <p><i>Upcharge for interval braked castors</i></p> <p><i>Upcharge for thicker upholstery</i></p>	<p>65 A51 37 97-xxx</p> <p>65 A51 37 97-xxx</p> <p>65 A51 37 97-xxx</p> <p>65 A51 37 97-xxx</p> <p>65 A51 37 97-xxx</p> <p>65 A51 37 97-xxx</p> <p>65 A51 37 97-xxx</p> <p>65 A51 37 97-xxx</p> <p>65 A51 37 97-xxx</p> <p>65 A53 37 97-xxx</p> <p>65 xxx 37 97-xxx</p> <p>65 B51 37 97-xxx</p>	<p>PG 1</p> <p>PG 2</p> <p>PG 3</p> <p>PG 4</p> <p>PG 5</p> <p>PG 6</p> <p>PG 7</p> <p>Leather*</p>	<p>1 074</p> <p>1 097</p> <p>1 125</p> <p>1 152</p> <p>1 182</p> <p>1 215</p> <p>1 263</p> <p>1 371</p> <p>29</p> <p>28</p> <p>59</p>

Base Design: Anderssen & Voll



Base chair / armchair, 4-legged



- Stackable chair / armchair with pressed seat shell
- Veneered in sh or oak veneer (nature/white pigmented/dark stained),
- Fully upholstered. Stopping in cold foam
- Stack protection in felt for upholstered chairs.
- Recommended stacking height: max 8 charis.
- Connectable in version without upholstery.
- Stand of 19 mm steel pipe, black TPE armrests, black plastic feet.
- Price for leather chairs in less than 4 pieces; against quotation.
- For more product information; see www.horreds.se

Colour stands (xx):

37 Black (RAL 9005)

13 Chrome: Models A11 and A10 only

(Other RAL colours against quotation)

	<p>Chair with upholstered seat shell, Incl stack protection in felt, black or chrome</p> <p>*Note:Leather min.4 chairs in same color</p> <p><i>Upcharge for sliding feet with felt</i> <i>Upcharge for thicker upholstery</i></p>	<p>65 A11 xx 97-xxx 65 A11 xx 97-xxx 65 A11 xx 97-xxx 65 A11 xx 97-xxx 65 A11 xx 97-xxx 65 A11 xx 97-xxx 65 A11 xx 97-xxx 65 A11 xx 97-xxx 65 A11 xx 97-xxx 65 A11 xx 97Fxxx 65 B11 xx 97-xxx</p>	<p>PG 1 PG 2 PG 3 PG 4 PG 5 PG 6 PG 7 Leather*</p>	<p>566 590 617 644 674 707 755 863 29 59</p>
	<p>Armchair with upholstered seat shell, Incl stack protection in felt, black.</p> <p>*Note: Leather min.4 chairs in same color</p> <p><i>Upcharge for sliding feet with felt</i> <i>Upcharge for thicker upholstery</i></p>	<p>65 A21 37 97-xxx 65 A21 37 97-xxx 65 A21 37 97-xxx 65 A21 37 97-xxx 65 A21 37 97-xxx 65 A21 37 97-xxx 65 A21 37 97-xxx 65 A21 37 97-xxx 65 A21 37 97-xxx 65 A21 37 97-xxx 65 A21 37 97-xxx 65 B21 37 97-xxx</p>	<p>PG 1 PG 2 PG 3 PG 4 PG 5 PG 6 PG 7 Leather*</p>	<p>752 775 802 829 860 893 941 1 049 29 59</p>

	<p>Chair with veneered seat shell, black or chrome</p> <p><i>Upcharge for connecting fittings</i> <i>Upcharge for sliding feet with felt</i></p>	<p>65 A10 xx 03 65 A10 xx 76</p> <p>65 A12 xx xx 65 A10 xx xxF</p>	<p>Oak Dark ash</p>	<p>396 396</p> <p>64 29</p>
	<p>Armchair with veneered seat shell, black.</p> <p><i>Upcharge for connecting fittings</i> <i>Upcharge for sliding feet with felt</i></p>	<p>65 A20 37 03 65 A20 37 76</p> <p>65 A22 37 xx 65 A22 37 xxF</p>	<p>Oak Dark ash</p>	<p>583 583</p> <p>64 29</p>

Base Design: Anderssen & Voll

Base med medstativ



- Stackable chair with pressed seat shell
- Veneered in oak nature and dark stained ash
- Fully upholstered. Stopping in cold foam
- Sled base of 12 mm wire
- Stack protection in felt for upholstered chairs.
- Connectable
- Price for leather chairs in less than 4 pieces: against quotation
- For more product information: see www.horreds.se

Colour stands (xx):

37 Black (RAL 9005)

(Other RAL colours against quotation)

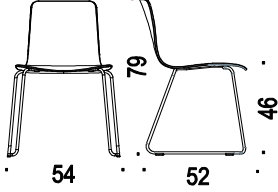
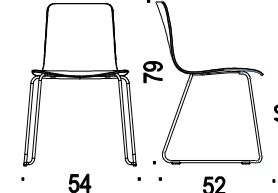
	<p>Chair with black sled base, fully upholstered</p> <p>*NB: Leather min.4 chairs in same colour</p> <p><i>Upcharge for thicker upholstery</i></p> <p><i>Upcharge for sliding feet with felt</i></p> <p><i>Upcharge cost for connecting fittings</i></p>	<p>65 A40 37 97-xxx</p> <p>65 A40 37 97-xxx</p> <p>65 A40 37 97-xxx</p> <p>65 A40 37 97-xxx</p> <p>65 A40 37 97-xxx</p> <p>65 A40 37 97-xxx</p> <p>65 A40 37 97-xxx</p> <p>65 A40 37 97-xxx</p> <p>65 A40 37 97-xxx</p> <p>65 B40 37 97-xxx</p> <p>65 A40 37 97-Fxxx</p> <p>65 A42 37 97-xxx</p>	<p>PG 1</p> <p>PG 2</p> <p>PG 3</p> <p>PG 4</p> <p>PG 5</p> <p>PG 6</p> <p>PG 7</p> <p>Leather*</p>	<p>514</p> <p>514</p> <p>541</p> <p>568</p> <p>598</p> <p>631</p> <p>679</p> <p>787</p> <p>59</p> <p>12</p> <p>17</p>
	<p>Chair with black sled base, veneered seat shell</p> <p><i>Upcharge for sliding feet with felt</i></p> <p><i>Upcharge cost for connecting fittings</i></p>	<p>65 A40 37 03</p> <p>65 A40 37 76</p> <p>65 A40 37 xxF</p> <p>65 A42 37 xx</p>	<p>Oak</p> <p>Dark ash</p>	<p>329</p> <p>329</p> <p>12</p> <p>17</p>


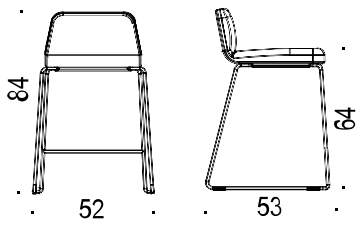
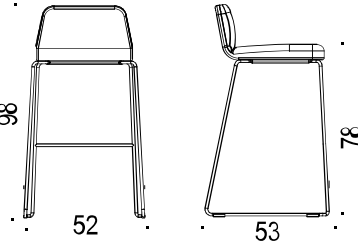
Illustration	Description	Article number	Price group	EUR
VX Bar stool Design: Horreds				
<div style="display: flex; align-items: flex-start;">  <div style="margin-left: 20px;"> <p>VX BAR STOOL</p> <ul style="list-style-type: none"> • Upholstered bar stool in two heights • Seat of molded plywood with cold foam • Stand of 12 mm wire, stackable 4 pcs • Stack protection in molded felt (anthracite gray) • For more product information; see www.horreds.se <p style="text-align: center;">Stand: Black RAL 9005 str (37) Chrome (13) <i>Other colour against quotation</i></p> </div> </div>				
	<p>Bar stool, seat height 640 mm</p> <p>*NB: Leather min. 2 chairs in same colour</p> <p><i>Upcharge for chrome</i></p> <p><i>Upcharge for sliding feet with felt</i></p>	<p>34 xx 07290-xxx</p> <p>34 13 07290-xxx</p> <p>34 xx 07290Fxxx</p>	<p>PG 1</p> <p>PG 2</p> <p>PG 3</p> <p>PG 4</p> <p>PG 5</p> <p>PG 6</p> <p>PG 7</p> <p>Leather*</p>	<p>476</p> <p>500</p> <p>527</p> <p>554</p> <p>584</p> <p>617</p> <p>665</p> <p>903</p> <p>47</p> <p>12</p>
	<p>Bar stool, seat height 780 mm</p> <p>*NB: Leather min. 2 chairs in same colour</p> <p><i>Upcharge for chrome</i></p> <p><i>Upcharge for sliding feet with felt</i></p>	<p>34 xx 07295-xxx</p> <p>34 xx 07295-xxx</p> <p>34 xx 07295Fxxx</p>	<p>PG 1</p> <p>PG 2</p> <p>PG 3</p> <p>PG 4</p> <p>PG 5</p> <p>PG 6</p> <p>PG 7</p> <p>Leather*</p>	<p>496</p> <p>519</p> <p>547</p> <p>573</p> <p>604</p> <p>637</p> <p>684</p> <p>922</p> <p>47</p> <p>12</p>


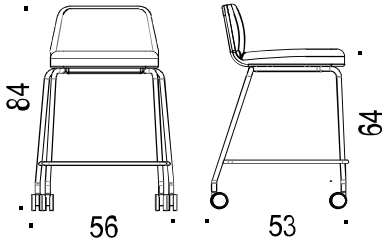


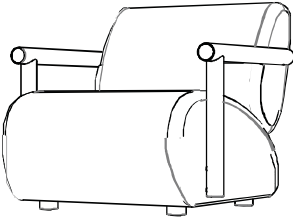
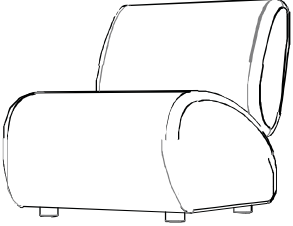
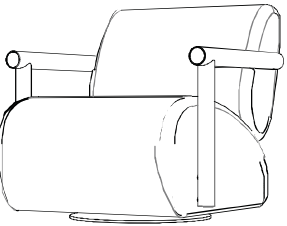
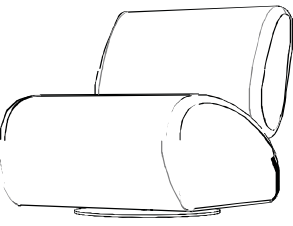
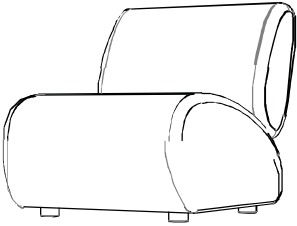
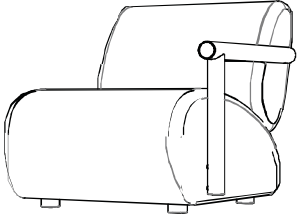
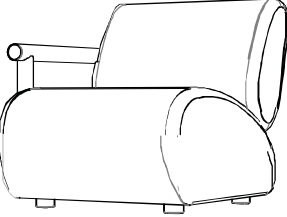
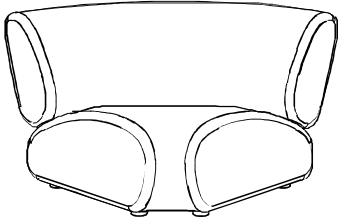
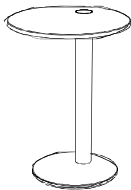
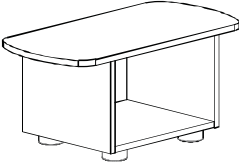
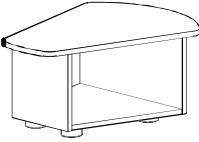
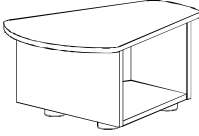
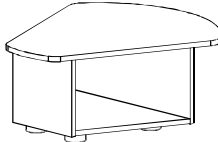
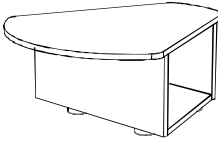
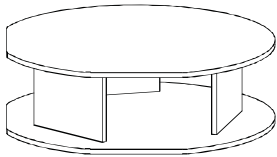
Illustration	Description	Article number	Price group	EUR
<p>VX Bar stool with castors Design: Horreds</p>				
	<p>VX Bar stool with castors</p> <ul style="list-style-type: none"> • Fully upholstered seat of molded plywood with cold foam. • Stand made of 19mm steel tube, footrest made of 14mm wire.. • Interval braked castors, polyurethane roller track, suitable for all floors. • Stack coverin molded felt, anthracite grey. • or more product information see www.horreds.se <p style="text-align: center;"><u>Stand:</u> Black RAL 9005 (37) (Other colours on request)</p>			
	<p>Stand with castors, black, seat height 640 mm</p> <p>*NB: Leather minimum number 2 pcs in the same colour.</p>	<p>34 37 08993-xxx</p>	<p>PG 1 PG 2 PG 3 PG 4 PG 5 PG 6 PG 7 Leather*</p>	<p>532 556 583 610 640 673 720 959</p>

Illustration	Description	Article number	Price group	EUR
LOG Design: Studio Stockholm Arkitektur				
<p>LOG Armchair / modular sofa</p> <ul style="list-style-type: none"> • Fully upholstered modular sofa with a seat height of 41 cm. • Wood and metal frame with HR foam. • CMHR foam upcharge € 144 / seating module. • Legs in solid oak, height 30mm. • For different fabrics in the seat and back, the price of the higher fabric group plus an upcharge of € 60 applies. • Coupling fittings to be ordered separately. • Leather modules against quotation • For more product information see www.horreds.se 				
				
	Armchairs			
	<p>Armchair</p> <p>Armrests and feet in hard wax oiled oak</p> <ul style="list-style-type: none"> • Width 710mm • Height 740mm (height armrests 565mm) • Depth 850mm • Seat height 410mm <p>Can not be coupled</p>	27 D5 202-xxx	PG 1 PG 2 PG 3 PG 4 PG 5 PG 6 PG 7	2 098 2 175 2 251 2 326 2 414 2 531 2 706
	<p>Seating module with back</p> <p>Feet in hard wax oiled oak</p> <ul style="list-style-type: none"> • Width 650mm • Height 740mm • Depth 850mm • Seat height 410mm 	27 D5 200-xxx	PG 1 PG 2 PG 3 PG 4 PG 5 PG 6 PG 7	1 458 1 534 1 610 1 685 1 773 1 890 2 065
	<p>Armchair swivel with auto return</p> <p>With armrests on hard wax oiled oak.</p> <p>Black footplate.</p> <ul style="list-style-type: none"> • Width 770mm • Height 740mm (höjd armstöd 565mm) • Depth 850mm • Seat height 410mm <p>Can not be coupled</p>	27 00 10202-xxx	PG 1 PG 2 PG 3 PG 4 PG 5 PG 6 PG 7	2 493 2 569 2 646 2 721 2 809 2 926 3 101
	<p>Armchair swivel with auto return</p> <p>Without armrests. Black footplate.</p> <ul style="list-style-type: none"> • Width 650mm • Height 740mm • Depth 850mm • Seat height 410mm <p>Can not be coupled</p>	27 00 10200-xxx	PG 1 PG 2 PG 3 PG 4 PG 5 PG 6 PG 7	1 853 1 929 2 005 2 080 2 168 2 285 2 460

	Modular soffa			
	Seating module with back Feet in hard wax oiled oak <ul style="list-style-type: none"> • Width 650mm • Height 740mm • Depth 850mm • Seat height 410mm Coupling fitting	27 D5	200-xxx	PG 1 1 458 PG 2 1 534 PG 3 1 610 PG 4 1 685 PG 5 1 773 PG 6 1 890 PG 7 2 065 23
	Seating module w.back, armrest left side Armrest and feet in hard vax oiled oak <ul style="list-style-type: none"> • Width 710mm • Height 740mm (height armrests 565mm) • Depth 850mm • Seat height 410mm Coupling fitting	27 D5	201-xxx	PG 1 1 778 PG 2 1 854 PG 3 1 930 PG 4 2 006 PG 5 2 094 PG 6 2 210 PG 7 2 386 23
	Seating module w.back, armrest right side Armrest and feet in hard vax oiled oak <ul style="list-style-type: none"> • Width 710mm • Height 740mm (height armrests 565mm) • Depth 850mm • Seat height 410mm Coupling fitting	27 D5	203-xxx	PG 1 1 778 PG 2 1 854 PG 3 1 930 PG 4 2 006 PG 5 2 094 PG 6 2 210 PG 7 2 386 23
	Corner module w. back. Feet in hard vax oiled oak <ul style="list-style-type: none"> • Width 95cm • Height 74cm • Depth 95cm • Seat height 41cm Coupling fittings (1/joint) Note: connect to seat modules, not against coupling modules.	27 D5	300-xxx	PG 1 2 265 PG 2 2 373 PG 3 2 481 PG 4 2 588 PG 5 2 714 PG 6 2 879 PG 7 3 129 23
	Laptop table. Top, leg and foot in hard vax oiled solid oak. Black metal parts. <ul style="list-style-type: none"> • Height 60cm • Top Ø40cm • Foot Ø30cm 	27 xx	9245	Oak 800

Coupling modules					
<ul style="list-style-type: none"> • Coupling modules in hard vax oiled oak • Height 290 mm. • For connection between 2 seating modules. Not intended as stand-alone modules • Electrical outlet as an option 					
	Table connection, straight, in hard vax oiled oak	27 D5	09130	Oak	545
	Same as above but with hole for 1 power outlet at the front	27 D5	09130K	Oak	545
	Coupling fittings (1/joint)		27001		23
 	Table coupling 30° inside in hard vax oiled oak	27 D5	09135I	Oak	653
	Same as above but with hole for 1 power outlet at the front	27 D5	09135IK	Oak	653
	Table coupling 30° outside in hard vax oiled oak	27 D5	09135U	Oak	653
	Same as above but with hole for 1 power outlet at the front	27 D5	09135UK	Oak	653
	Coupling fittings (1/joint)		27001		23
 	Table coupling 45° inside in hard vax oiled oak	27 D5	09140I	Oak	690
	Same as above but with hole for 1 power outlet at the front	27 D5	09140IK	Oak	690
	Table coupling 45° outside in hard vax oiled oak	27 D5	09140U	Oak	690
	Same as above but with hole for 1 power outlet at the front	27 D5	09140UK	Oak	690
	Coupling fittings (1/joint)		27001		23
	Table coupling corner 90° in hard vax oiled oak (not available with power outlet) Coupling fittings (1/joint)	27 D5	09125 27001	Oak	775 23

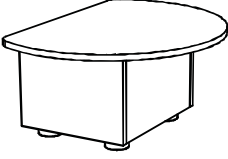
	Table coupling / final module in hard wax oiled oak. Bredd 45cm, höjd 29cm.	27 D5 09185	Oak	576
	Lika ovan men med håltagning för 1 st eluttag.	27 D5 09185K	Oak	576
	Kopplingsbeslag (1/skarv)	27001		23
Power outlets to coupling modules				
	Powerdot 1 x power incl cable entry 51 mm	935 -PM50 935 -PM50W	Black White	63 63
	Powerdot 2 x USB-A charger incl cable entry 51 mm	935 -PM51 935 -PM51W	Black White	103 103
	Powerdot 2 x USB-C PD charger incl cable entry 51 mm	935 -PM52 935 -PM52W	Black White	144 144

Illustration	Description	Article number	EUR																																																
Mute Focus Design: Fredrik Mattson																																																			
	<p>Mute Focus SEATING FURNITURE</p> <ul style="list-style-type: none"> • Frame in lacquered or veneered chipboard. • Stuffing in HR foam. CMHR against upcharge. • Seat height 46 cm • Delivered assembled, only the table top needs to be assembled. • For more produk information see www.horreds.se <p>White lacquer: NCS 0500-N Veneer group 1: Oak (03), Ash (06) Veneer group 2: Black ash (86), Dark ash (76), White oak (30), White ash (10)</p>																																																		
	<p><i>Mute Focus Low & Mute Focus, fully upholstered</i></p>				<p><i>Mute Focus Low & Mute Focus, veneered outside</i></p>																																														
	<p>Mute Focus Low, left, fully upholstered, 1220x770x790 mm Incl. 1xpower + 1xdouble USB-A charger (PM50+51) Black metal legs. Delivered assembled, only the table needs to be assembled. Max.weight for table top: 50 kg. Upcharge for CMHR</p>	<p>55Fxx 400V-xxx</p>	<table border="1"> <thead> <tr> <th>Fabric group</th> <th>Table white lacquer</th> <th>Table optional NCS</th> <th>Table veneer group 1</th> <th>Table veneer group 2</th> </tr> </thead> <tbody> <tr><td>PG 1</td><td>3 587</td><td>3 587</td><td>3 587</td><td>3 587</td></tr> <tr><td>PG 2</td><td>3 771</td><td>3 771</td><td>3 771</td><td>3 771</td></tr> <tr><td>PG 3</td><td>3 980</td><td>3 980</td><td>3 980</td><td>3 980</td></tr> <tr><td>PG 4</td><td>4 188</td><td>4 188</td><td>4 188</td><td>4 188</td></tr> <tr><td>PG 5</td><td>4 421</td><td>4 421</td><td>4 421</td><td>4 421</td></tr> <tr><td>PG 6</td><td>4 679</td><td>4 679</td><td>4 679</td><td>4 679</td></tr> <tr><td>PG 7</td><td>5 047</td><td>5 047</td><td>5 047</td><td>5 047</td></tr> <tr><td></td><td>72</td><td>72</td><td>72</td><td>72</td></tr> </tbody> </table>	Fabric group	Table white lacquer	Table optional NCS	Table veneer group 1	Table veneer group 2	PG 1	3 587	3 587	3 587	3 587	PG 2	3 771	3 771	3 771	3 771	PG 3	3 980	3 980	3 980	3 980	PG 4	4 188	4 188	4 188	4 188	PG 5	4 421	4 421	4 421	4 421	PG 6	4 679	4 679	4 679	4 679	PG 7	5 047	5 047	5 047	5 047		72	72	72	72			
Fabric group	Table white lacquer	Table optional NCS	Table veneer group 1	Table veneer group 2																																															
PG 1	3 587	3 587	3 587	3 587																																															
PG 2	3 771	3 771	3 771	3 771																																															
PG 3	3 980	3 980	3 980	3 980																																															
PG 4	4 188	4 188	4 188	4 188																																															
PG 5	4 421	4 421	4 421	4 421																																															
PG 6	4 679	4 679	4 679	4 679																																															
PG 7	5 047	5 047	5 047	5 047																																															
	72	72	72	72																																															
	<p>Mute Focus Low, right, fully upholstered, 1220x770x790 mm Incl. 1xpower + 1xdouble USB-A charger (PM50+51) Black metal legs. Delivered assembled, only the table needs to be assembled. Max.weight for table top: 50 kg. Upcharge for CMHR</p>	<p>55Fxx 400H-xxx</p>	<table border="1"> <thead> <tr> <th>Fabric group</th> <th>Table white lacquer</th> <th>Table optional NCS</th> <th>Table veneer group 1</th> <th>Table veneer group 2</th> </tr> </thead> <tbody> <tr><td>PG 1</td><td>3 587</td><td>3 587</td><td>3 587</td><td>3 587</td></tr> <tr><td>PG 2</td><td>3 771</td><td>3 771</td><td>3 771</td><td>3 771</td></tr> <tr><td>PG 3</td><td>3 980</td><td>3 980</td><td>3 980</td><td>3 980</td></tr> <tr><td>PG 4</td><td>4 188</td><td>4 188</td><td>4 188</td><td>4 188</td></tr> <tr><td>PG 5</td><td>4 421</td><td>4 421</td><td>4 421</td><td>4 421</td></tr> <tr><td>PG 6</td><td>4 679</td><td>4 679</td><td>4 679</td><td>4 679</td></tr> <tr><td>PG 7</td><td>5 047</td><td>5 047</td><td>5 047</td><td>5 047</td></tr> <tr><td></td><td>72</td><td>72</td><td>72</td><td>72</td></tr> </tbody> </table>	Fabric group	Table white lacquer	Table optional NCS	Table veneer group 1	Table veneer group 2	PG 1	3 587	3 587	3 587	3 587	PG 2	3 771	3 771	3 771	3 771	PG 3	3 980	3 980	3 980	3 980	PG 4	4 188	4 188	4 188	4 188	PG 5	4 421	4 421	4 421	4 421	PG 6	4 679	4 679	4 679	4 679	PG 7	5 047	5 047	5 047	5 047		72	72	72	72			
Fabric group	Table white lacquer	Table optional NCS	Table veneer group 1	Table veneer group 2																																															
PG 1	3 587	3 587	3 587	3 587																																															
PG 2	3 771	3 771	3 771	3 771																																															
PG 3	3 980	3 980	3 980	3 980																																															
PG 4	4 188	4 188	4 188	4 188																																															
PG 5	4 421	4 421	4 421	4 421																																															
PG 6	4 679	4 679	4 679	4 679																																															
PG 7	5 047	5 047	5 047	5 047																																															
	72	72	72	72																																															

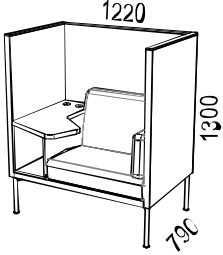
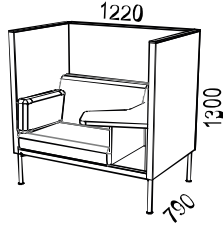
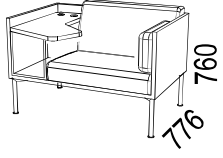
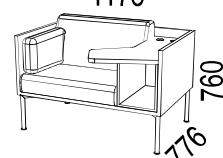
Illustration	Description	Article number	EUR				
			Fabric group	Table white lacquer	Table optional NCS	Table veneer group 1	Table veneer group 2
	<p>Mute Focus left, fully upholstered. 1220x1300x790 mm Incl. 1xpower + 1xdouble USB-A charger (PM50+51) Delivered assembled, only the table needs to be assembled. Max.weight for table top: 50 kg. <i>Upcharge for CMHR</i></p>	55Fxx 300V-xxx	PG 1	4 067	4 067	4 067	4 067
			PG 2	4 353	4 353	4 353	4 353
			PG 3	4 677	4 677	4 677	4 677
			PG 4	5 002	5 002	5 002	5 002
			PG 5	5 365	5 365	5 365	5 365
			PG 6	5 765	5 765	5 765	5 765
			PG 7	6 338	6 338	6 338	6 338
						97	97
	<p>Mute Focus right, fully upholstered. 1220x1300x790 mm Incl. 1xpower + 1xdouble USB-A charger (PM50+51) Delivered assembled, only the table needs to be assembled. Max.weight for table top: 50 kg. <i>Upcharge for CMHR</i></p>	55Fxx 300H-xxx	PG 1	4 067	4 067	4 067	4 067
			PG 2	4 353	4 353	4 353	4 353
			PG 3	4 677	4 677	4 677	4 677
			PG 4	5 002	5 002	5 002	5 002
			PG 5	5 365	5 365	5 365	5 365
			PG 6	5 765	5 765	5 765	5 765
			PG 7	6 338	6 338	6 338	6 338
						97	97
	<p>Mute Focus Low, left, 1175x760x776 mm Incl. 1xpower + 1xdouble USB-A charger (PM50+51) Black metal legs. Delivered assembled, only the table needs to be assembled. Max.weight for table top: 50 kg. <i>Upcharge for CMHR</i></p>	55Fxx 200V-xxx	Fabric group	White laquer	Optional NCS	Veneer group 1	Veneer group 2
			PG 1	3 826	4 230	4 353	4 757
			PG 2	3 898	4 303	4 426	4 830
			PG 3	3 970	4 375	4 498	4 902
			PG 4	4 043	4 447	4 570	4 975
			PG 5	4 127	4 531	4 654	5 058
			PG 6	4 238	4 642	4 765	5 170
			PG 7	4 405	4 810	4 933	5 337
Leather	4 719	5 123	5 247	5 651			
			48	48	48	48	
	<p>Mute Focus Low, right, 1175x760x776 mm Incl. 1xpower + 1xdouble USB-A charger (PM50+51) Black metal legs. Delivered assembled, only the table needs to be assembled. Max.weight for table top: 50 kg. <i>Upcharge for CMHR</i></p>	55Fxx 200H-xxx	PG 1	3 826	4 230	4 353	4 757
			PG 2	3 898	4 303	4 426	4 830
			PG 3	3 970	4 375	4 498	4 902
			PG 4	4 043	4 447	4 570	4 975
			PG 5	4 127	4 531	4 654	5 058
			PG 6	4 238	4 642	4 765	5 170
			PG 7	4 405	4 810	4 933	5 337
			Leather	4 719	5 123	5 247	5 651
			48	48	48	48	

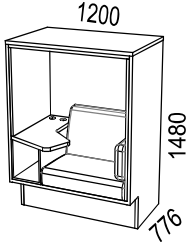
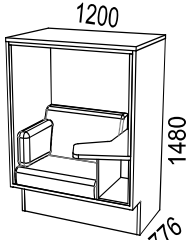
Illustration	Description	Article number	EUR				
			Fabric group	White laquer	Optional NCS	Veneer group 1	Veneer group 2
	<p>Mute Focus left 1200x1480x776 mm Incl. 1xpower + 1xdouble USB-A charger (PM50+51) Led lightning. Delivered assembled, only the table needs to be assembled. Max.weight for table top: 50 kg. <i>Upcharge for CMHR</i></p>	55Fxx 100V-xxx	PG 1	5 453	5 936	6 588	7 072
			PG 2	5 659	6 142	6 795	7 278
			PG 3	5 866	6 349	7 002	7 485
			PG 4	6 073	6 556	7 209	7 692
			PG 5	6 311	6 794	7 447	7 930
			PG 6	6 629	7 113	7 765	8 249
			PG 7	7 107	7 590	8 242	8 726
			Leather	7 195	7 678	8 330	8 814
				85	85	85	85
				<p>Mute Focus right 1200x1480x776 mm Incl. 1xpower + 1xdouble USB-A charger (PM50+51) Led lightning. Delivered assembled, only the table needs to be assembled. Max.weight for table top: 50 kg. <i>Upcharge for CMHR</i></p>	55Fxx 100H-xxx	PG 1	5 453
PG 2	5 659	6 142				6 795	7 278
PG 3	5 866	6 349				7 002	7 485
PG 4	6 073	6 556				7 209	7 692
PG 5	6 311	6 794				7 447	7 930
PG 6	6 629	7 113				7 765	8 249
PG 7	7 107	7 590				8 242	8 726
Leather	7 195	7 678				8 330	8 814
	85	85				85	85
		Upcharge for optional powerdot with double USB-C charger (PM52).				55	
		Note: price per piece					


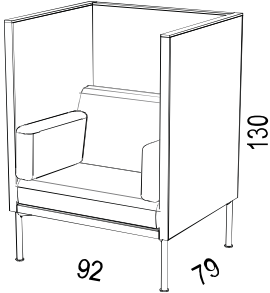
Illustration	Description	Article number	Price group	EUR
<p>Mute Focus Easy chair Design: Fredrik Mattson</p>				
	<p>Mute Focus Easy chair</p> <ul style="list-style-type: none"> • Upholstered easy chair with padding in HR foam • Seat height 46 cm • Delivered assembled • For more produkt information see; www.horreds.se 			
	<p>Mute Focus easy chair, upholstered 92x130x79cm Seat height 46cm Black metal legs. Delivered assembled.</p>	<p>55F 500 -xxx</p>	<p>PG 1 PG 2 PG 3 PG 4 PG 5 PG 6 PG 7</p>	<p>2 634 2 904 3 175 3 442 3 754 4 168 4 789</p>

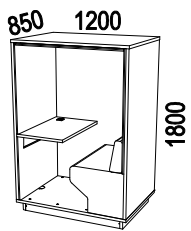
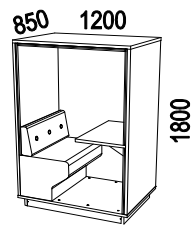
Illustration	Description	Article number	EUR				
			Fabric group	White laquer	Optional NCS	Veneer group 1	Veneer group 2
	Mute Floor left 1200x1800x850 mm Inkl.1 xpower 1x double USB-A charger (PD50+51) LED lamp ,mat anthracite. Delivered assembled Max.weight for table top: 50 kg. <i>Upcharge for CMHR foam</i> With back wall, entrance from one side	55 xx 311V-xxx	PG 1	6 426	7 689	8 194	8 615
			PG 2	6 607	7 871	8 376	8 797
			PG 3	6 970	8 234	8 739	9 160
			PG 4	7 152	8 415	8 921	9 342
			PG 5	7 515	8 778	9 284	9 705
			PG 6	7 914	9 177	9 682	10 104
			PG 7	8 513	9 776	10 281	10 702
			Leather	8 967	10 230	10 736	11 157
				60	60	60	60
			<p><i>NOTE: Mute Floor x1 (art 311V/H) is delivered assembled!</i> Please notify customer service if it has to be delivered knock-down due to size limit of entrance doors. The width of the pallet is 95 cm.</p>				
	Mute Floor right 1200x1800x850 mm Inkl.1 xpower 1x double USB-A charger (PD50+51) LED lamp, mat anthracite Delivered assembled Max.weight for table top: 50 kg. <i>Upcharge for CMHR foam</i> With back wall, entrance from one side	55 xx 311H-xxx	PG 1	6 426	7 689	8 194	8 615
			PG 2	6 607	7 871	8 376	8 797
			PG 3	6 970	8 234	8 739	9 160
			PG 4	7 152	8 415	8 921	9 342
			PG 5	7 515	8 778	9 284	9 705
			PG 6	7 914	9 177	9 682	10 104
			PG 7	8 513	9 776	10 281	10 702
			Leather	8 967	10 230	10 736	11 157
				60	60	60	60
			<p><i>NOTE: Mute Floor x1 (art 311V/H) is delivered assembled!</i> Please notify customer service if it has to be delivered knock-down due to size limit of entrance doors. The width of the pallet is 95 cm.</p>				
Upcharge for optional powerdot with double USB-C charger (PM52). Note: price per piece						55	

Illustration	Description	Article number	EUR
--------------	-------------	----------------	-----

Mute Design:Fredrik Mattson

Mute SOFA AND EASY CHAIR



- Frame in lacquered or veneered chipboard.
- Stuffing in HR foam. CMHR against upcharge.
- Seat height 46 cm
- Delivered assembled.
- For more produk information see www.horreds.se

White lacquer: NCS 0500-N

Veneer group 1: Oak (03), Ash (06)

Veneer group 2: Black ash (86), Dark ash (76), White oak (30), White ash (10)



			Fabric group	White laquer	Optional NCS	Veneer group 1	Veneer group 2
	Mute sofa with roof 2000x1480x776 mm Delivered assembled. <i>(Notify customer serv. at the time of ordering if you want it to be sent unassembled!)</i> Upcharge for CMHR	55 xx 04350-xxx	PG 1	6 587	7 293	9 005	9 509
			PG 2	6 860	7 565	9 277	9 781
			PG 3	7 114	7 819	9 532	10 035
			PG 4	7 295	8 001	9 713	10 217
			PG 5	7 604	8 309	10 022	10 526
			PG 6	8 003	8 708	10 421	10 924
			PG 7	8 602	9 307	11 020	11 523
			Leather	12 632	13 337	15 050	15 553
	85	85	85	85			
	Mute easy chair with roof 950x1480x776 mm Delivered assembled. Upcharge for CMHR	55 xx 03650-xxx	PG 1	4 633	5 338	5 641	6 044
			PG 2	4 815	5 520	5 822	6 225
			PG 3	4 960	5 665	5 967	6 370
			PG 4	5 087	5 792	6 094	6 497
			PG 5	5 268	5 974	6 276	6 679
			PG 6	5 518	6 223	6 525	6 928
			PG 7	5 892	6 597	6 899	7 302
			Leather	7 719	8 424	8 726	9 129
	60	60	60	60			


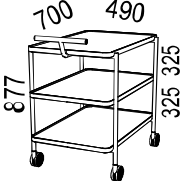
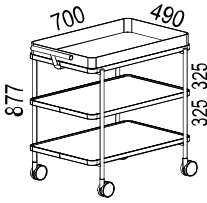
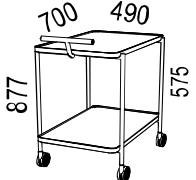
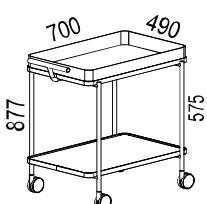



Illustration	Description	Article number	Material	EUR
EXO TROLLEY Design: Mathieu Gustafsson & Daniel Lavonius Jarefeldt, Tengbom				
	<p>EXO-TROLLEY Serving Trolley</p> <ul style="list-style-type: none"> • Trolley in black texture lacquer RAL9005 with castors. Other colours on request. • Shelves in white (31K) and black (37K) compact laminate alternatively oak and ash veneer; oak nature (03), ash nature (06) black ash (86), dark ash (76), white oak (30), white ash (10), stained ash Burgundy (C8), stained ash Conifer (D3) and stained ash Smokey Blue (D4). • Troughs in black metal and copper, • Serving tray and bottle holder in black metal with inlays matching the shelves. • 4 castors (diameter 75 mm) of which 2 are lockable. • Max weight capacity 50 kilos. • For more product information: see www.horreds.se 			
	<p>Trolley with 3 shelves in compact laminate alt. veneer New: height 877 mm</p>	84 37xx 08383-2	Black	1 574
	<p>Trolley with 1 trough and 2 shelves in compact laminate or veneer. New: height 877 mm <i>Add.cost for extra trough instead of shelf. Price per trough.</i></p>	84 37xx S8383-4 84 37xx K8383-4	Black/trough black Black/trough copper Black Copper	1 707 4 019 134 2 445
	<p>Trolley with 2 shelves in compact laminate alt. veneer New: height 877 mm</p>	84 37xx 08383-1	Black	1 348
	<p>Trolley with 1 trough and 1 shelf in compact laminate or veneer. New: height 877 mm <i>Add.cost for extra trough instead of shelf</i></p>	84 37xx S8383-3 84 37xx K8383-3	Black/trough black Black/trough copper Black Copper	1 483 3 794 134 2 445
	<p>Serving tray in black metal, with inlay in same material as shelves</p>	84 37xx 05424	Black	365
	<p>Bottle holder in black metal, for 3 bottles, with inlay in same material as shelves</p>	84 37xx 05423	Black	378
	<p>Bottle holder in black or white metal, for 6 bottles, with inlay in same material as shelves</p>	84 37xx 05425	Black	389



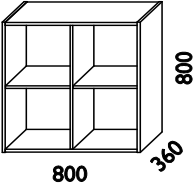
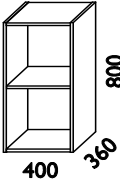
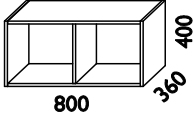
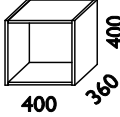
Illustration	Description	Article number	Material	EUR
	<p>ANNE Design: Anne Krook.</p> <ul style="list-style-type: none"> • White NCS 0500-N. • Veneer: Oak (03), Birch (05) and Ash (06). • Works as a room divider. • Backs in HDF (white to white units and wood pattern to units in birch and oak). • Doors attach only to outer side of units. • Drawers can only be assembled into deep units. • Doors and drawers are assembled before delivery; therefore always enclose a drawing of your Anne combination. • Remote control works through glass doors only (not wooden doors). • Doors with soft-closing hinges. • Drawers with self-closing function. • For more information, see www.horreds.se 	 MÖBELFAKTA		
Anne DEEP BASIC UNITS				
	<p>Deep basic unit with stationary divider and adjustable shelves.</p> <p>Deep basic unit with stationary divider, without shelves.</p>	<p>16 xx 009D 16 31 009D</p> <p>16 xx 009DU 16 31 009DU</p>	<p>Oak/Birch White</p> <p>Oak/Birch White</p>	<p>621 597</p> <p>595 572</p>
	<p>Deep basic unit with adjustable shelf.</p> <p>Deep basic unit without shelf.</p> <p>Deep basic unit with adjustable shelf, without back.</p>	<p>16 xx 011D 16 31 011D</p> <p>16 xx 011DU 16 31 011DU</p> <p>16 xx 011DO 16 31 011DO</p>	<p>Oak/Birch White</p> <p>Oak/Birch White</p> <p>Oak/Birch White</p>	<p>380 365</p> <p>354 340</p> <p>348 334</p>
	<p>Deep basic unit with stationary divider.</p> <p>Deep basic unit without divider.</p> <p>Deep basic unit with stationary divider, without back.</p> <p>Deep basic unit without divider, without back.</p>	<p>16 xx 012D 16 31 012D</p> <p>16 xx 012DU 16 31 012DU</p> <p>16 xx 012DO 16 31 012DO</p> <p>16 xx 012DUO 16 xx 012DUO</p>	<p>Oak/Birch White</p> <p>Oak/Birch White</p> <p>Oak/Birch White</p> <p>Ek/Björk Vit</p>	<p>380 365</p> <p>354 340</p> <p>348 334</p> <p>321 308</p>
	<p>Deep basic unit.</p> <p>Deep basic unit without back</p>	<p>16 xx 013D 16 31 013D</p> <p>16 xx 013DO 16 31 013DO</p>	<p>Oak/Birch White</p> <p>Oak/Birch White</p>	<p>251 241</p> <p>223 214</p>

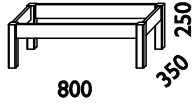

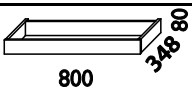
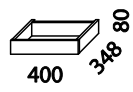
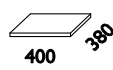
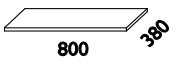
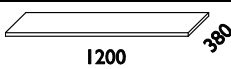
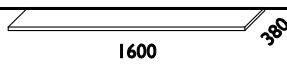
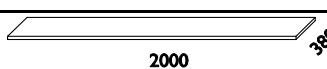
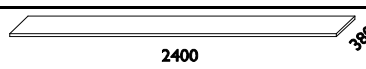
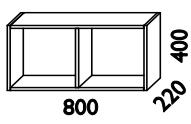
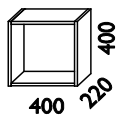
Illustration	Description	Article number	Material	EUR
Anne BASES				
	Deep leg base, wood, 800 mm	16 xx 017D 16 31 017D	Oak/Birch White	242 242
	Deep leg base, wood, 400 mm	16 xx 018D 16 31 018D	Oak/Birch White	211 211
	Deep base, wood, 800 mm	16 xx 007D 16 31 007D	Oak/Birch White	114 114
	Deep base, wood, 400 mm	16 xx 008D 16 31 008D	Oak/Birch White	92 92
	Max weight capacity 40 kilos. 800 mm 400 mm	16 00 045 16 00 046		49 39
Anne TOP SHELVES. • Depth 380 mm. 23 mm thick. • Only suitable to deep basic units (not for shallow units or TV-cabinets).				
	Length 400 mm	16 xx 201 16 31 201	Oak/Birch White	176 176
	Length 800 mm	16 xx 202 16 31 202	Oak/Birch White	204 204
	Length 1200 mm	16 xx 203 16 31 203	Oak/Birch White	238 238
	Length 1600 mm	16 xx 204 16 31 204	Oak/Birch White	299 299
	Length 2000 mm	16 xx 206 16 31 206	Oak/Birch White	346 346
	Length 2400 mm	16 xx 207 16 31 207	Oak/Birch White	389 389
Anne SHALLOW BASIC UNITS FOR WALL				
	Shallow basic unit with stationary divider.	16 xx 012G 16 31 012G	Oak/Birch White	370 355
	Shallow basic unit without divider.	16 xx 012GU 16 31 012GU	Oak/Birch White	343 330
	Wallhanging kit in MDF. 800 mm.	16 00 045		49
	Shallow basic unit.	16 xx 013G 16 31 013G	Oak/Birch White	232 223
	Wallhanging kit in MDF. 400 mm.	16 00 046		39

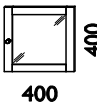
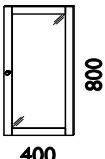
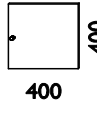
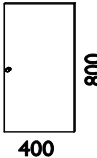
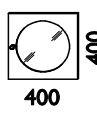
Illustration	Description	Article number	Material	EUR
Anne DOORS		Närmaste NCS:		
		White NCS 0500-N		
		Grey green NCS S2502G		
		Yellow NCS S1050-Y10R		
	Glass door Anne	16 xx 031	Oak/Birch	188
	Glass door Anne, with frosted glass	16 31 031	White	188
		16 xx 031A	Oak/Birch	211
		16 31 031A	White	211
	Glass door Anne	16 xx 032	Oak/Birch	246
	Glass door Anne, with frosted glass	16 31 032	White	246
		16 xx 032A	Oak/Birch	269
		16 31 032A	White	269
	Door Anne	16 xx 021	Oak/Birch	107
		16 31 021	White	107
		16 48 021	Grey-green	107
		16 49 021	Yellow	107
	Door Anne	16 xx 022	Oak/Birch	193
		16 31 022	White	193
		16 48 022	Grey-green	193
		16 49 022	Yellow	193
	Glass door Anne, with round glass	16 xx 034	Oak/Birch	143
		16 31 034	White	143
		16 48 034	Grey-green	143
		16 49 034	Yellow	143
	Glass door Anne, with round frosted glass	16 xx 034A	Oak/Birch	166
		16 31 034A	White	166
		16 48 034A	Grey-green	166
		16 49 034A	Yellow	166

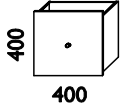
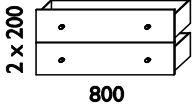
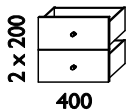


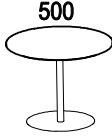
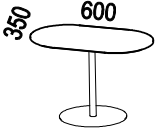
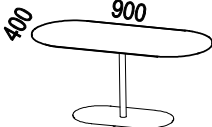
Illustration	Description	Article number	Material	EUR
Anne DRAWERS				
<ul style="list-style-type: none"> • With soft- and self-closing funktion. • Incl standard handle in brushed steel • Fits only in deep basic units 				
	Drawer Anne	16 xx 039	Oak/Birch	229
		16 31 039	White	229
		16 48 039	Grey-green	229
		16 49 039	Yellow	229
	Pair of drawers Anne. Only for basic unit 12DU.	16 xx 040	Oak/Birch	515
		16 31 040	White	515
		16 48 040	Grey-green	515
		16 49 040	Yellow	515
	Pair of drawers Anne.	16 xx 041	Oak/Birch	363
		16 31 041	White	363
		16 48 041	Grey-green	363
		16 49 041	Yellow	363
Anne ACCESSORIES				
	Wine rack for 9D	16 31 042A	White	143
		16 48 042A	Grey-green	143
		16 49 042A	Yellow	143
	Wine rack for 11D + 12D	16 31 042B	White	143
		16 48 042B	Grey-green	143
		16 49 042B	Yellow	143
	Wine rack for 13D	16 31 042C	White	143
		16 48 042C	Grey-green	143
		16 49 042C	Yellow	143
	Deep extra shelf for 9D/9DU+12D. Width 37,5 cm.	16 xx 044	Oak/Birch	57
		16 31 044	White	57
	Deep extra shelf for 11D/11DU+13D With 36,7 cm.	16 xx 044B	Oak/Birch	57
		16 31 044B	White	57
	Shallow extra shelf for 12G Width 37,5 cm.	16 xx 047	Oak/Birch	50
		16 31 047	White	50
	Shallow extra shelf for 13G With 36,7 cm.	16 xx 047B	Oak/Birch	50
		16 31 047B	White	50
	Deep extra shelf for 12DU Width 76,8 cm.	16 xx 050	Oak/Birch	128
		16 31 050	White	128
	Deep glass shelf for 9D/9DU + 12D	16 00 048	Glass	43
	Deep glass shelf for 11D/11DU + 13D	16 00 048B	Glass	43
	Shallow glass shelf for 9G/9GU + 12G	16 00 049	Glass	38
	Shallow glass shelf for 11G/11GU + 13G	16 00 049B	Glass	38
	Mounted lock in door	16 00 058		142

Illustration	Description	Article number	Material	EUR
--------------	-------------	----------------	----------	-----

	<p>LAP Design: Fredrik Mattson</p> <ul style="list-style-type: none"> • Table top in 14 mm white compact laminate with black core and chamfered edge alternatively 19 mm veneered MDF 19. • Column leg in white powder coated steel (RAL 9016) • Available in 3 heights. Illustrations below show table in height 430 mm • To round top and to oval top in size 600x350 the column base is round • To oval top in size 900x400 the column base is oval <p><u>Veneer group 1:</u> Oak (03), Ash (06), Birch (05), Beech (04) <u>Veneer group 2:</u> Black stained Ash (86), Dark stained Ash (76), White pigmented Oak (30), White pigmented Ash (10)</p> <p><u>Heights:</u> 430 mm (1), 530 mm (2), 630 mm (3)</p>
---	--

 <p>500</p>	Round table top, diameter 500 mm, including column leg with round base Height; 430, 530 or 630 mm.	55 xx xx 03802-x 55 xx xx 03802-x 55 31 xx 03802-x	Veneer gr 1 Veneer gr 2 White comp.lam.	458 470 519
 <p>600 350</p>	Oval table top, 600x350 mm, including column leg with round base Height; 430, 530 or 630 mm.	55 xx xx 03803-x 55 xx xx 03803-x 55 31 xx 03803-x	Veneer gr 1 Veneer gr 2 White comp.lam.	476 488 543
 <p>900 400</p>	Oval table top, 900x400 mm, including column leg with oval base Height; 430, 530 or 630 mm.	55 xx xx 03804-x 55 xx xx 03804-x 55 31 xx 03804-x	Veneer gr 1 Veneer gr 2 White comp.lam.	507 519 579

SALES TERMS

All previous price lists are no longer valid. All prices are quoted in Euro excl. VAT.
Our digital price list is regularly updated and products may be added or discontinued.
Price adjustments may occur. For the latest issue, see www.horreds.se

TERMS OF PAYMENT

30 days net or according to agreement.

When payment falls due, we reserve the right charge 2% interest/month. Payment by cheque is not accepted. Only International bank transfers are accepted. Bank details according to the invoice.

TERMS OF DELIVERY

Deliveries will only be effected at our terms of payment and delivery. The goods remain the property of Horreds Möbel AB until full payment has been settled. Dispatch date is when goods are leaving factory. Standard package is included, pallets and wooden crates are charged separately. Tail gates, fixed delivery date and telephone notification will be charged separately. Quotations submitted by Horreds are, unless otherwise stated, valid for 30 days from the quotation date. For deliveries well ahead of time, e.g. 6 months from the quotation date, this must be agreed on each individual occasion.

FREIGHT CHARGES

Europe 1

Finland, Latvia, Lithuania, Estonia, Germany, Benelux.

Free delivery DAP on order above 2500 Euro net. For orders less than 2500 Euro, a freight cost of 225 Euro is charged.

Europe 2

Austria, United Kingdom, Poland, Czech Republic, Slovakia, Hungary.

Free delivery DAP on order above 2500 Euro net. For orders less than 2500 Euro, a freight cost of 350 Euro is charged.

Other countries

Ex Works or according to agreement. (documents sent by courier will be charged)

CLAIMS AND TRANSPORT DAMAGES

Any claims or transport damages must be reported to Horreds. A special claim report shall be sent in together with photos to export@horreds.se. Visible damages must also be notified on the waybill when receiving the goods. Invisible damages must be reported within 6 days. Photos must be taken on all damages for us to be able to handle the claim.

GUARANTEE

Office furniture according to Price list 1: 10 years for wood and metal parts with the exception of electric legs having 5 years and clothing material for table screens and insert materials which have 1 year.

Meeting places/Environmental furniture according to Price list 2: 5 years with the exception of clothing material and input material which have 1 year.

Input material such as locks, hinges, electrical parts, expanders and lamps: 1 year.

Customized products: 1 year.

The guarantees are valid from the date of the original invoice against production errors at normal use of the product. We reserve the right to make changes in construction and design without notice.

FORCE MAJEURE

Horreds shall not be liable for any loss, damage, delay, changes in shipment schedules or failure to deliver caused by accidents, fire, strikes, riots, civil commotion, insurrection, war, the elements, embargoes, failure of carriers, inability to obtain transportation facilities, government requirements, acts of God or public enemy, prior orders from customers or limitations on the company's or its supplier's production or marketing activities or any other causes or contingencies beyond the company's control.

SHOWROOMS:

Horreds Möbel ab (Head Office), Varbergsvägen 448, HORRED. Tel +46 320 184 00

Horreds Möbel AB, Rosenlundsgatan 54, STOCKHOLM. Tel +46 73 828 00 15

Studio L6, Lasarettsgatan 6, GÖTEBORG. Tel +46 70 241 99 69

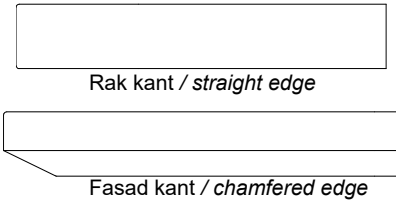
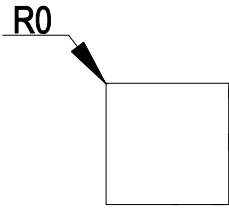

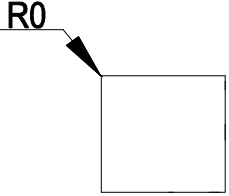
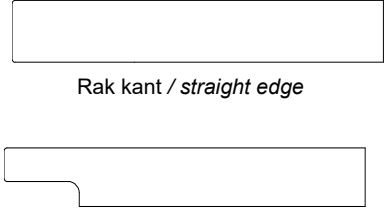
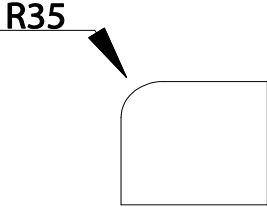
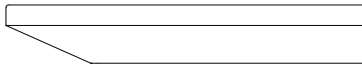
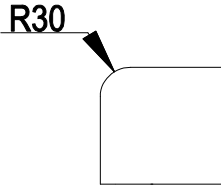

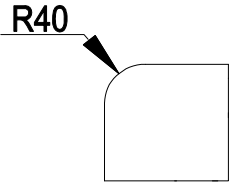

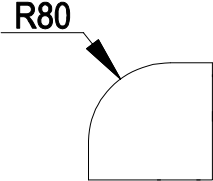
Studio Krøger AS, Nobelsgate 18, OSLO. Tel +47 90 02 89 98

pCon PLANNER

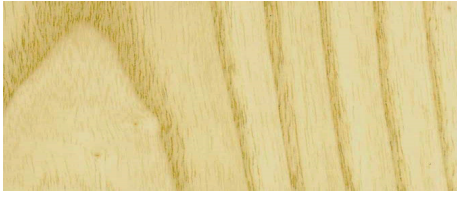
Download pCon planner and use our 3D dwg files which are available in pCon Cataloge

For additional information and for download free of charge:
see www.horreds.se

www.pcon-planner.com

	<u>Profil / profile:</u>	<u>Radie / radius:</u>
<p><u>VX</u> Rak matchande kantlist i plast alternativt faner <i>Straight edge, matching edging</i></p>	 <p>Rak kant / <i>straight edge</i> Fasad kant / <i>chamfered edge</i></p>	<p>R0</p> 
<p><u>A-frame, Nomono, Tin, Tapp</u> Rak, matchande kantlist i plast alternativt faner <i>Straight edge, matching edging</i></p>		<p>R0</p> 
<p><u>Siglo</u> Matchande kantlist i plast till Laminat och desktop. Vit kantlist i plast till fanerade bord. <i>Matching edging to laminate and linoleum. White edging to veneered desks.</i></p>	 <p>Rak kant / <i>straight edge</i> Falsad kant / <i>chamfered edge</i></p>	<p>R35</p> 
<p><u>Fri</u> Klarlackad fasad mdf-kant <i>Clear coated chamfeed MDF edge</i></p>	 <p>Fasad kant / <i>chamfered edge</i></p>	<p>R30</p> 
<p><u>Henry skrivbord / desks</u> Rak, vit plastkantlist <i>Straight edge, white edging</i></p>		<p>R40</p> 
<p><u>Henry mötesbord / meeting tables</u> Rak, vit plastkantlist <i>Straight edge, white edging</i></p>		<p>R80</p> 

BORDSSKIVOR FANER / TABLE TOPS VENEER



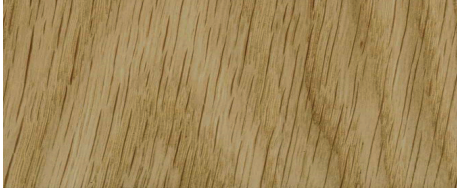
06 Ask / Ash



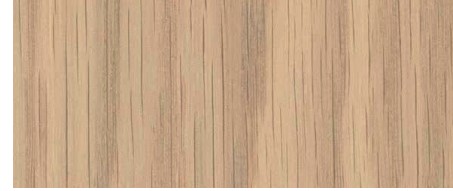
10 Vit ask / White ash



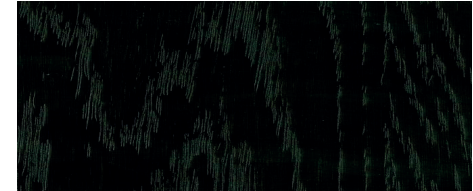
76 Mörk ask / Dark ash



03 Ek / Oak



30 Vit ek / White oak



86 Svart ask / Black ash



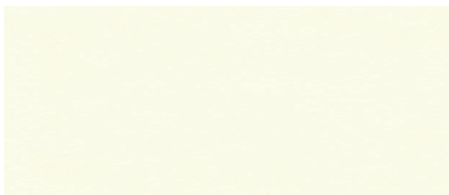
05 Björk / Birch



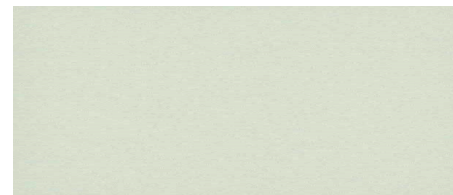
04 Bok / Beech

Tänk på: I trä som är en naturprodukt kan mindre avvikelser i bets och struktur förekomma /
Note: In wood, that is a natural product, minor deviations in stain and structure can occur

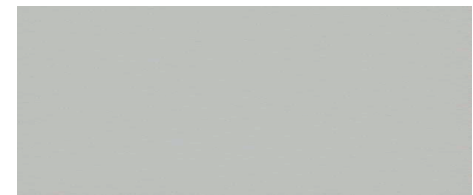
BORDSSKIVOR LAMINAT / TABLE TOPS HPL



Vit 0754 (standardlaminat)
närmaste NCS S0502-Y



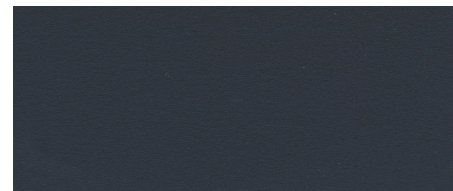
Ljusgrå 0419 (tillvalslaminat)
närmaste NCS S1500-N



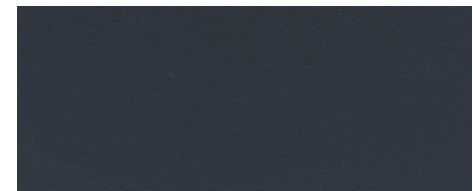
Ljusgrå 1365 (tillvalslaminat)
närmaste NCS S2005-R80B



Mellangrå 1023 (tillvalslaminat)
närmaste NCS S5500-N



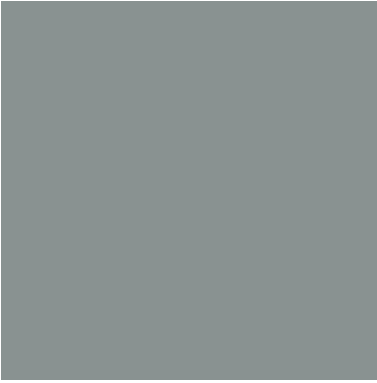
Antracit 1397 (tillvalslaminat)
närmaste NCS S7500-N



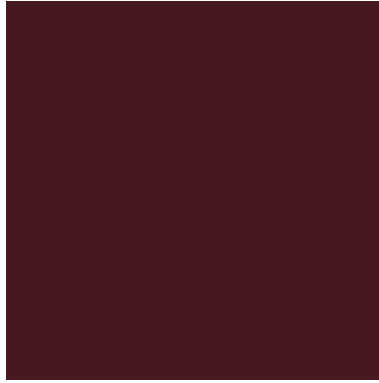
Svart 2253 (tillvalslaminat)
närmaste NCS S9000-N

Färgavvikelser kan förekomma av trycktekniska skäl /
Colour deviations may occur for technical reasons

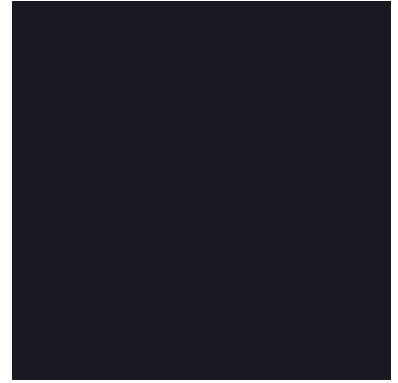
BORDSSKIVOR DESKTOP / TABLE TOPS LINOLEUM



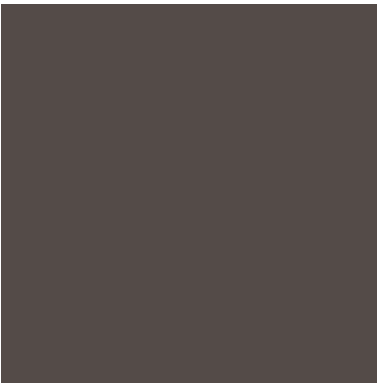
4132 Ash
closest NCS 5502-G



4154 Burgundy
closest NCS 7010-R10B



4166 Charcoal
closest NCS 8502-B



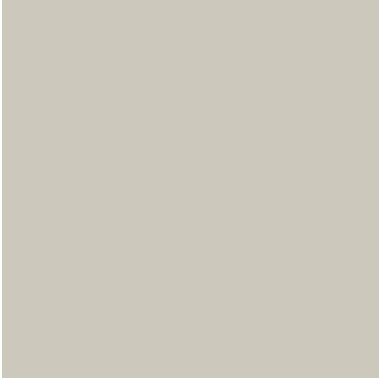
4172 Mauve
closest NCS 7005-Y80R



4174 Conifer
closest NCS 8010-B90G



4175 Pebble
closest NCS 3502-Y



4176 Mushroom
closest NCS 2002-Y



4177 Vapour
closest NCS 2005-G10Y



4179 Smokey Blue
closest NCS 7010-R90B



4184 Olive
closest NCS 5010-G50Y

Färgavvikelser kan förekomma av trycktekniska skäl

NOMONO HANDTAG



Svart, black
närmaste NCS S9000-N



Gul, yellow
närmaste NCS S1070-Y



Grön, green
närmaste NCS S2570-G30Y



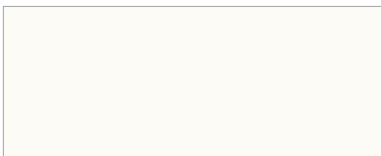
Röd, red
närmaste NCS S1580-Y80R



Turkosblå, turquoise
närmaste NCS S0540-B30G



Orange, orange
närmaste NCS S1080-Y50R



Vit, white
närmaste NCS S0300-N

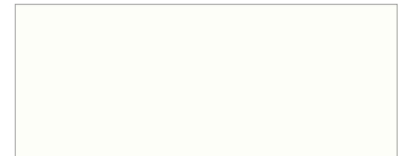
ANNE-HYLLAN



Björkfaner, birch veneer



Ekfaner, oak veneer



Vit, white
närmaste NCS S0500-N



Grågrön, grey-green
närmaste NCS S2502-G



Gul, yellow
närmaste NCS S1050-Y10R

Price groups fabrics

Below you will find a list of standard fabrics for our seating furniture.

The list shows the difference price groups and which products it is suitable for.

For price information for fabrics not listed below; please send us a price inquiry.

Several of our products can be produced with multiple fabrics; please send us a price inquiry.

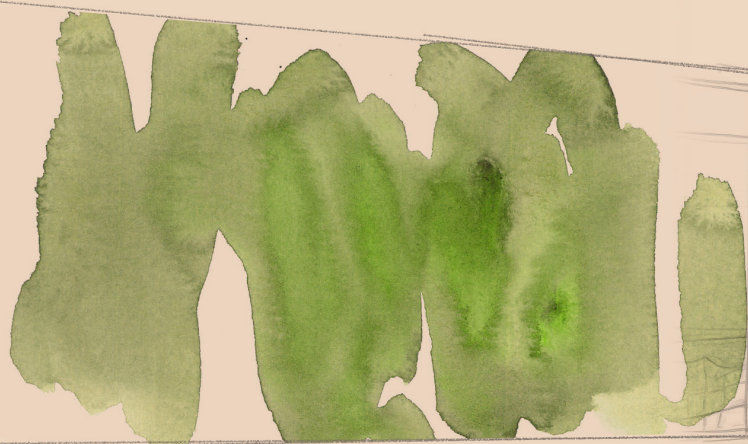
Leverantör:	Tyg:	Prisgrup p:	Base / Cuba	Glove	VX barpall	Mute / LOG	Grand
Camira	Main Line Flax	PG1	•	•	•	•	•
Camira	Main Line Twist	PG1	•	•	•	•	•
Gabriel	Bond	PG1	•	•	•	•	•
Gabriel	Focus	PG1	•	•	•	•	•
Gabriel	Focus Melange	PG1	•	•	•	•	•
Gabriel	Go Uni	PG1	•	•	•	•	•
Gabriel	Medley	PG1	•	•	•	•	•
Gabriel	Step	PG1	•	•	•	•	•
Nevotex	Grace	PG1	•	•	•	•	•
Nevotex	Pod	PG1			•	•	•
Camira	Blazer	PG2	•	•	•	•	•
Gabriel	Go Check	PG2	•	•	•	•	•
Gabriel	Go Couture	PG2	•	•	•	•	•
Gabriel	Step Melange	PG2	•	•	•	•	•
Gabriel	Tempt	PG2	•	•	•	•	•
Kvadrat	Reflect	PG2	•	•	•	•	•
Kvadrat	Relate	PG2	•	•	•	•	•
Kvadrat	Remix	PG2	•	•	•	•	•
Nevotex	Lido	PG2	•	•	•	•	•
Nevotex	Lido Trend	PG2	•	•	•	•	•
Nevotex	Stella	PG2	•	•	•	•	•
Svensson	Ally	PG2	•	•	•	•	•
Svensson	Easy	PG2	•	•	•	•	•
Vescom	Avon	PG2	•	•	•	•	•
Vescom	Arches	PG2	•	•		•	•
Vescom	Arrow	PG2	•	•		•	•
Vescom	Creek	PG2	•	•		•	•
Vescom	Cyprus	PG2	•	•		•	•
Vescom	Dalma	PG2	•	•		•	•
Vescom	Furka Plus	PG2	•	•		•	•
Vescom	Jemo	PG2	•	•		•	•
Vescom	Leone Plus	PG2	•	•		•	•
Vescom	Malta	PG2	•	•		•	•
Vescom	Samar	PG2	•	•	•	•	•
Vescom	Scott	PG2	•	•		•	•
Camira	Synergy	PG3	•	•	•	•	•
Camira	Yoredale	PG3	•	•	•	•	•
Gabriel	Breeze Fusion	PG3	•	•	•	•	•
Gabriel	Capture	PG3	•	•	•	•	•
Gabriel	Crisp	PG3	•	•	•	•	•
Gabriel	Fame	PG3	•	•	•	•	•

Gabriel	Grain	PG3	•	•	•	•	•
Gabriel	Morph	PG3	•	•	•	•	•
Gabriel	Select	PG3	•	•	•	•	•
Kvadrat	Atlas	PG3	•	•	•	•	•
Nevotex	Blues	PG3	•	•	•	•	•
Nevotex	Funk	PG3	•	•	•	•	•
Nevotex	Imola Plus	PG3	•	•	•	•	•
Nevotex	Jazz	PG3	•	•	•	•	•
Nevotex	Pop	PG3	•	•	•	•	•
Nevotex	Wooly	PG3	•	•	•	•	•
Svensson	Harper	PG3	•	•	•	•	•
Svensson	Heritage Blend	PG3	•	•	•	•	•
Svensson	Semi	PG3	•	•	•	•	•
Svensson	Step	PG3	•	•	•	•	•
Vescom	Harding	PG3	•	•	•	•	•
Vescom	Norfolk	PG3	•	•	•	•	•
Vescom	Wilson	PG3	•	•	•	•	•
Vescom	Acton	PG3	•	•	•	•	•
Vescom	Rocket	PG3	•	•	•	•	•
Bogesunds	Liv	PG4	•	•	•	•	•
Gabriel	Passion	PG4	•	•	•	•	•
Jørgenssen	Puxx 1/2	PG4	•	•	•	•	•
Kvadrat	Canvas	PG4	•	•	•	•	•
Kvadrat	Re-wool	PG4	•	•	•	•	•
Kvadrat	Sabi	PG4	•	•	•	•	•
Kvadrat	Steelcut	PG4	•	•	•	•	•
Kvadrat	Steelcut Trio	PG4	•	•	•	•	•
Kvadrat	Tonica	PG4	•	•	•	•	•
Kvadrat	Tonus	PG4	•	•	•	•	•
Nevotex	Barnum	PG4	•	•	•	•	•
Nevotex	Grand Lazio Velvet	PG4	•	•	•	•	•
Svensson	Ink	PG4	•	•	•	•	•
Svensson	Mingel	PG4	•	•	•	•	•
Svensson	Rami	PG4	•	•	•	•	•
Vescom	Auckland	PG4	•	•	•	•	•
Vescom	Foster	PG4	•	•	•	•	•
Vescom	Moore	PG4	•	•	•	•	•
Vescom	Burton	PG4	•	•	•	•	•
Vescom	Dikson	PG4	•	•	•	•	•
Vescom	Fuga	PG4	•	•	•	•	•
Vescom	Gamut	PG4	•	•	•	•	•
Vescom	Hestan	PG4	•	•	•	•	•
Gabriel	Focus Royal	PG5	•	•	•	•	•
Gabriel	Savoy	PG5	•	•	•	•	•
Kvadrat	Devina / Devina MD	PG5	•	•	•	•	•
Kvadrat	Devina Melange	PG5	•	•	•	•	•
Kvadrat	Fiord	PG5	•	•	•	•	•
Kvadrat	Foss	PG5	•	•	•	•	•
Kvadrat	Hallingdal	PG5	•	•	•	•	•
Kvadrat	Hero	PG5	•	•	•	•	•
Kvadrat	Melange NAP	PG5	•	•	•	•	•

Kvadrat	Steelcut Quartet	PG5	•	•	•	•	•
Maharam	Merit	PG5	•	•	•	•	•
Maharam	Messenger	PG5	•	•	•	•	•
Nevotex	Illusion	PG5	•	•		•	•
Nevotex	Illusion Full grain	PG5	•	•		•	•
Svensson	Balance	PG5	•	•	•	•	•
Svensson	Debut	PG5	•	•	•	•	•
Vescom	Lamu	PG5	•	•	•	•	•
Vescom	Lani	PG5	•	•	•	•	•
Vescom	Wolin	PG5	•	•	•	•	•
Gabriel	Nobel	PG6	•	•	•	•	•
Kvadrat	Arda	PG6	•	•	•	•	•
Kvadrat	Mizmaze	PG6	•	•	•	•	•
Kvadrat	Coda	PG7	•	•	•	•	•
Kvadrat	Drop	PG7	•	•	•	•	•
Kvadrat	Sisu	PG7	•	•	•	•	•
Vescom	Billiard Cloth	PG7	•	•	•	•	•
Elmo Leather	Elmonordic	Läder	•	•	•	•	•
Elmo Leather	Elmosoft	Läder	•	•	•	•	•
Nevotex	Lambada	Läder	•	•	•	•	•
Nevotex	Linea	Läder	•	•	•	•	•
Nevotex	Vintage	Läder	•	•	•	•	•

Rev.2024-01-01

**BE THE
REBEL
WITH A
PURPOSE.**



Horreds Möbel AB
Varbergsvägen 448, SE-519 30 Horred, SWEDEN
vx. +46 320 184 00, info@horreds.se

www.horreds.se