

PRICE LIST 2026

VERSION 02

HORR[®] EDS 1936



90
HORRIS
EDS
1936





BE THE REBEL WITH A PURPOSE.

Horreds designs, manufactures and sells office, lounge and meeting furniture with many built-in, truly unique added values that we sum up in one word: “rebel quality”. This means that we deliver products that withstand the wear of time, shifts in design trends, and can be renewed again and again. Long-term thinking is also reflected in our environmental commitment and our quality certifications. We place great emphasis on surfaces, the feel of wood, and details.

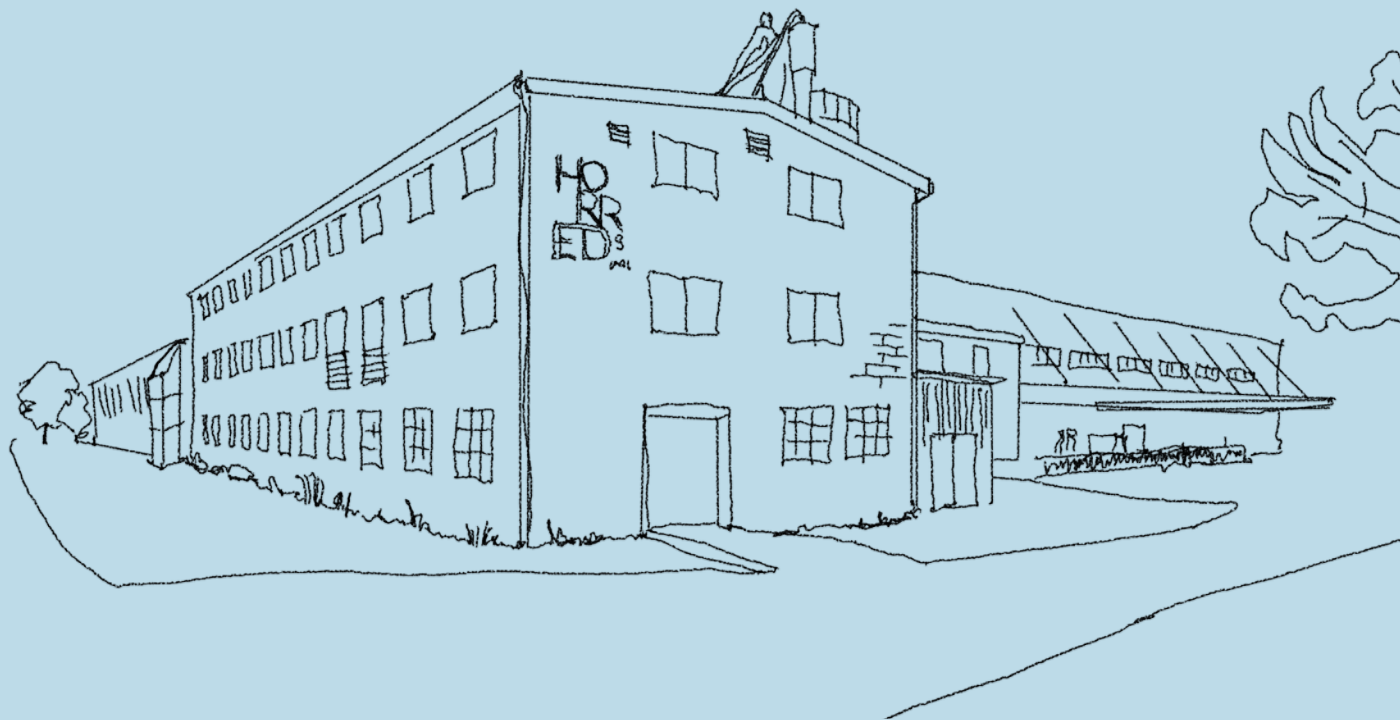
Since 1936, our ambition has been to create lasting impressions through long-term, sustainable design.

WE ARE TURNING 90 YEARS OLD.

Here, in the mill town of Horred in Sweden, our grandfather Sven’s curiosity was sparked by the need for smart and functional furniture. At just 14 years old, he began his journey in the furniture world by working for his father, who manufactured children’s beds and doll’s beds. It was his passion for craftsmanship and the unique character of wood as a material that inspired Sven. At the age of 25, he purchased a piece of land to found Horreds Möbel in 1936. From the very beginning, the company produced bespoke joinery such as cabinets, tables and chairs.

This year, we celebrate 90 years and continue with the same strong commitment within a culture that has been built over three generations. A continuity and passion that have permeated our work and shaped who we are today. By combining solid craftsmanship with modern innovation, we continuously strive to deliver furniture of premium quality that exceeds our customers’ expectations. We are proud of our history and look forward to continuing our journey with a strong vision for the future.

OUR FACTORY IN HORRED.



All furniture manufacturing takes place here in the mill town of Horred, in western Sweden, with a few exceptions. Our local surroundings, in the heart of the Halland countryside, influence us and our view of furniture making. Concepts such as “local” and “long-term” have been deeply rooted in our company culture since the very beginning. Our mission is to create furniture that lasts and serves a lifelong purpose.

WOOD, CERTIFICATIONS AND MINIMISED WASTE

The majority of our furniture is made of wood. A fantastic, renewable material. For 90 years, since the very beginning, we have worked with this material, building a deep knowledge base on how to use wood in the best possible way. Here, we operate Northern Europe’s leading and most environmentally friendly production lines for MDF and lacquered products. Through our state-of-the-art spray booth, all wooden components are hand-sprayed to preserve the genuine feel of the wood.

Horreds is ISO 9001:2015 certified, and the majority of our products are labelled with Möbelfakta — two very important cornerstones for us.

We work in line with the UN Agenda 2030 and focus on areas that are relevant to us. This is part of our commitment to contributing to a more sustainable future.



If you'd like to visit our factory, we'd be happy to arrange it. Send us an email at info@horreds.se.

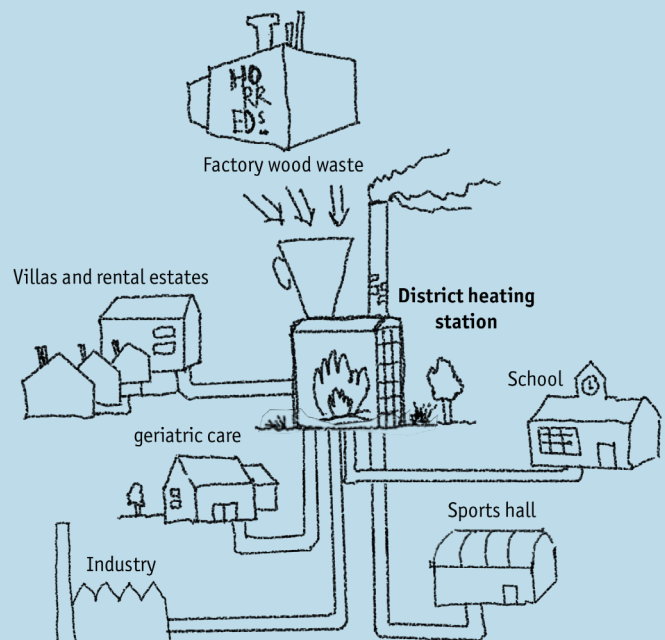
For the same reason, we use only green electricity from hydropower plants, produced within a 10-kilometre radius of Horred. The wood waste generated is reused as energy in our district heating facility, which supplies heat to the local school, retirement home, healthcare centre, apartments and houses in Horred.

All manufacturing is made to order, with minimised waste and environmental impact.

The majority of our furniture comes with a ten-year warranty.

CUSTOM ADAPTATIONS

We are pleased to offer custom adaptations for our customers, which are sometimes needed to complement interior projects. Our knowledge of materials, wood, production techniques, well-considered details and how different surfaces should be joined gives our customers truly unique possibilities.



REUSE – FURNITURE TO LOVE FOR A LONG TIME

A piece of furniture from Horreds can be renewed and given a new life through the replacement of tabletops, frames, soft components, as well as, for example, transforming cabinets into personal storage solutions.

Our philosophy regarding reuse is to invest in sustainable furniture from the very beginning — to make a long-term choice. This benefits both you as a customer and the environment. Horreds furniture can be reused or recycled to almost 100%.

HORREDS PRICE LIST EUR EXCL.VAT 2026-02-01

PRICE LIST 1: Office Furniture	
Fast delivery products	7
<u>A-FRAME</u>	
Desks	8-10
Screens and accessories	11
<u>NOMONO COMPACT</u>	
Nomono Compact	12-17
<u>NOMONO</u>	
Example arrangements	18-23
Nomono with gables	24-31
Nomono with T-legs	32-35
<u>SIGLO</u>	
Desks	36-39
Screens	40
<u>OTHER DESKS</u>	
VX/Henry/Fri	41-45
Cable entries	46-47
VX8 / VX11 bordsstativ	48-49
VX Duo	50-51
<u>SCREENS</u>	
VX desk screen	52-53
A-Frame desk screen	11
<u>OFFICE STORAGE</u>	
Storage with sliding doors, depth 43cm.	
Basic units	54-56
Extension units / trays	57
Bases	58-59
Sliding doors Biblio	60-62
Sliding doors Nomono	63-65
Sliding doors VX	66-68
Siglo	69-72
Storage with hinged doors, depth 43cm	73-74
Accessories storage	75
Personal storage	
VX personal storage	76-81
Side storage	
Biblio	82-83
Nomono A-side	84-85
Siglo	86-88
VX	89-90
Accessories	91

PRICE LIST 2: Meeting / Seating	
<u>MEETING TABLES</u>	
VX Konferens / VX Projekt	92-105
Nomono konferens	106-107
Nomono Meeting	108
Levels	109
Tin	110-111
Kabelluckor och tillbehör	112-115
<u>SEATING FURNITURE / VARIOUS</u>	
Prime chair	116-117
Grand chair	118-121
Grand Balk	122-123
Glove chair	124-127
Glove Bolster Cover	128
Glove Lounge	129
Glove Bar stool	130
Cuba chair	131-132
Cuba chair with quilted upholstery	133-134
Base chair	135-138
VX Bar stool	139
VX Bar stool with castors	140
Log Armchair and Module sofa	141-144
Nomono Bench	145
Mute Focus	146-148
Mute Focus easy chair	149
Mute Floor	150-151
Mute sofa and easy chair	152
Exo Trolley	153
<u>SHELF SYSTEMS</u>	
Parant	154-157
Connect	158
Anne	159-162
<u>LOUNGE TABLES / COFFEE TABLES</u>	
Levels	109
Lap	163
Log Laptop table	142

<u>INFORMATION:</u>	
Sales terms	164
Pcon Planner	165
Desk profiles	166
Colour charts	167-170
Price groups fabrics	171-173

Our digital price list is updated continuously.

Products may be added or expire and
price adjustments may occur.

For the latest edition, see www.horreds.se

Fast delivery products



COMPLETE WORK PLACE IN 10 DAYS

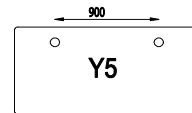
Good logistics solutions are the savior of some projects

The products will be shipped from us within 10 business days.

We choose not to put any max volumes on this range but must reserve us for out-of-stock.

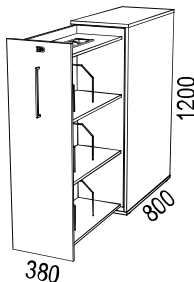


VX tabletops are available in white alt. grey direct laminate (19 mm particle board), white high pressure laminate (19 mm MDF) and black linoleum (19 mm MDF). Comes with 2 cable entries including plastic cover in white or black.



VX11 electric stand:

- Range 65 cm (table height 61-126 cm)
- Colours: white (RAL9016) / black (RAL9005)
- Flexible frame 1156-1756 mm (svart RAL9005)
- Lifting force 800N / lg
- Power consumption in standby mode: 0,1 W / PVC-free system
- 5 års warranty
- With built-in anti-collision function (DS1)

Desk tops VX	Article nr	White direct laminate (31S)	Light grey dir.lam. (61S)	Vit laminate (HPL) (31)	Black linoleum (88)
VX tabletop 1600x800 mm with 2 st cable holes plac Y5	34xx481-07061	200	269		
VX tabletop 1400x800 mm with 2 st cable holes plac Y5	34xx481-07297	200	269		
VX tabletop 1200x800 mm with 2 st cable holes plac Y5	34xx481-08148	187	241		
VX tabletop 1600x800 mm with 2 st cable holes plac Y5	34xx167025K			460	627
VX tableTop 1400x800 mm with 2 st cable holes plac Y5	34xx167024K			460	627
VX tabletop 1200x800 mm with 2 st cable holes plac Y5	34xx167023K			460	627
Electric stand VX11	Article nr	White (31)	Black (37)		
VX 11 range 65 cm	VX11xx657-1	549	549		
Accessories	Article no	White (31)	Black (37)		
Cable tray 1100 mm (for table tops 1600 och 1400 mm)	29xx140	105	105		
Side storage		Article nr	White		
<i>Choose colour of handle: white, black or stainless steel look</i>					
	VX side storage 380x1200x800 mm. White dir.laminate, incl pen holder and brackets. Left or right. (Illustration shows left)	343121B	1 074		

A-Frame Design: Anderssen & Voll**A-FRAME**

- A-Frame tabletops are made of 19 mm MDF with straight edge.
- Radius 0.
- Shape rectangular
- Cable lid in same material as table top as option. Placed on left side as standard. om inget annat anges vid beställningstillfället.

- **High Pressure laminate:**

White HPL (lam 0754)	Closest NCS: S0502-Y
Light grey HPL (optional lam 0419)	S2002-Y
Light grey HPL (optional lam 1365)	S2005-R80B
Medium grey HPL (opt. lam. 1023)	S5500-N
Anthracite HPL (opt. lam. 1397)	S7500-N
Black HPL (optional lam 2253)	S9000-N

- **Veneer group 1:**

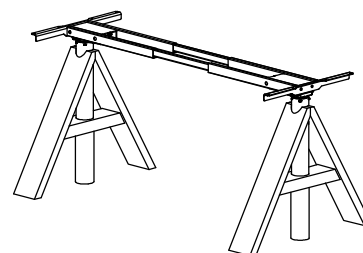
- Oak nature (03)
- Ash nature (06)

- **Veneer group 2:**

- White pigmented oak (30)
- White pigmented ash (10)
- Black stained ash (86)
- Dark stained ash (76)
- Burgundy ash (C8)
- ConifeR ash (D3)
- Smokey Blue ash (D4)
- Olive ash (D6)
- Mushroom ash (D7)

- **Linoleum from Forbo Flooring:**

- | | |
|------------------|-----------|
| 4132 Ash | 5502-G |
| 4154 Burgundy | 7010-R10B |
| 4166 Charcoal | 8502-B |
| 4172 Mauve | 7005-Y80R |
| 4174 Conifer | 8010-B90G |
| 4175 Pebble | 3502-Y |
| 4176 Mushroom | 2002-Y |
| 4177 Vapour | 2005-G10Y |
| 4179 Smokey Blue | 7010-R90B |
| 4184 Olive | 5010-G50Y |



- Electric stand, range 50 cm (desk height 70-120 cm). Electric legs in white (RAL 9016) or black (RAL 9005), with solid wooden A-legs in oak or ash.. Lifting force 800N/leg. 0,1 w power consumption in standby mode ,5 years warranty..
- Brackets information is referring to the desk height (incl the table top)
- Horreds height adjustment control (touchpad) milled in desk top as option.
- For additional product information please see www.horreds.se

A-Frame Design: Anderssen & Voll

E Desks within size 1600x800 mm

Note: Separate prices top tops and stands.

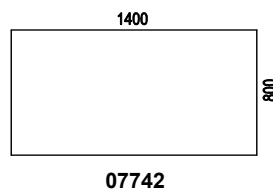
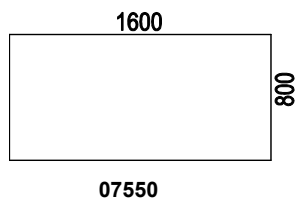
Select first the table top, then add price for stand and options.
The table's drawing number is listed under the table symbol.

Tabletops	Article no	White laminate (HPL)	Optional laminate (HPL)	Linoleum	Veneer group 1	Veneer group 2
A-Frame desk top in E-format	64xx16xxxxE	306	548	367	458	458

Stands	Article no	Solid wood A-legs with white metal legs	Solid wood A-legs with black metal legs
Electric stand range 50 cm (70-120) with solid A-legs in oak or ash (nature/stained/white pigmented)	64xx31250-x 64xx37250-x	1 327	1 327

Options:		Upcharge:
Cable lid	64xx07438	157
Horreds touch pad	343707444	56
Veneered edge on laminate table		107
Veneered edge on linoleum table*		107

* only oak/ash nature + white pigmented (not stained).



A-Frame Design: Anderssen & Voll

B

Desks within size 2000x900 mm

Note: Separate prices top tops and stands.

Select first the table top, then add price for stand and options.

The table's drawing number is listed under the table symbol.

Tabletops	Article no	White laminate (HPL)	Optional laminate (HPL)	Linoleum	Veneer group 1	Veneer group 2
A-Frame desk top in B-format	64xx16xxxxB	371	584	401	514	514

Stands	Article no	Solid wood A-legs with white metal legs	Solid wood A-legs with black metal legs
Electric stand range 50 cm (70-120) with solid A-legs in oak or ash (nature/stained/white pigmented)	64xx31250-x 64xx37250-x	1 327	1 327

Options:		Upcharge:
Cable lid	64xx07438	157
Horreds touch pad	343707444	56
Veneered edge on laminate table		107
Veneered edge on linoleum table*		107

* only oak/ash nature + white pigmented (not stained).

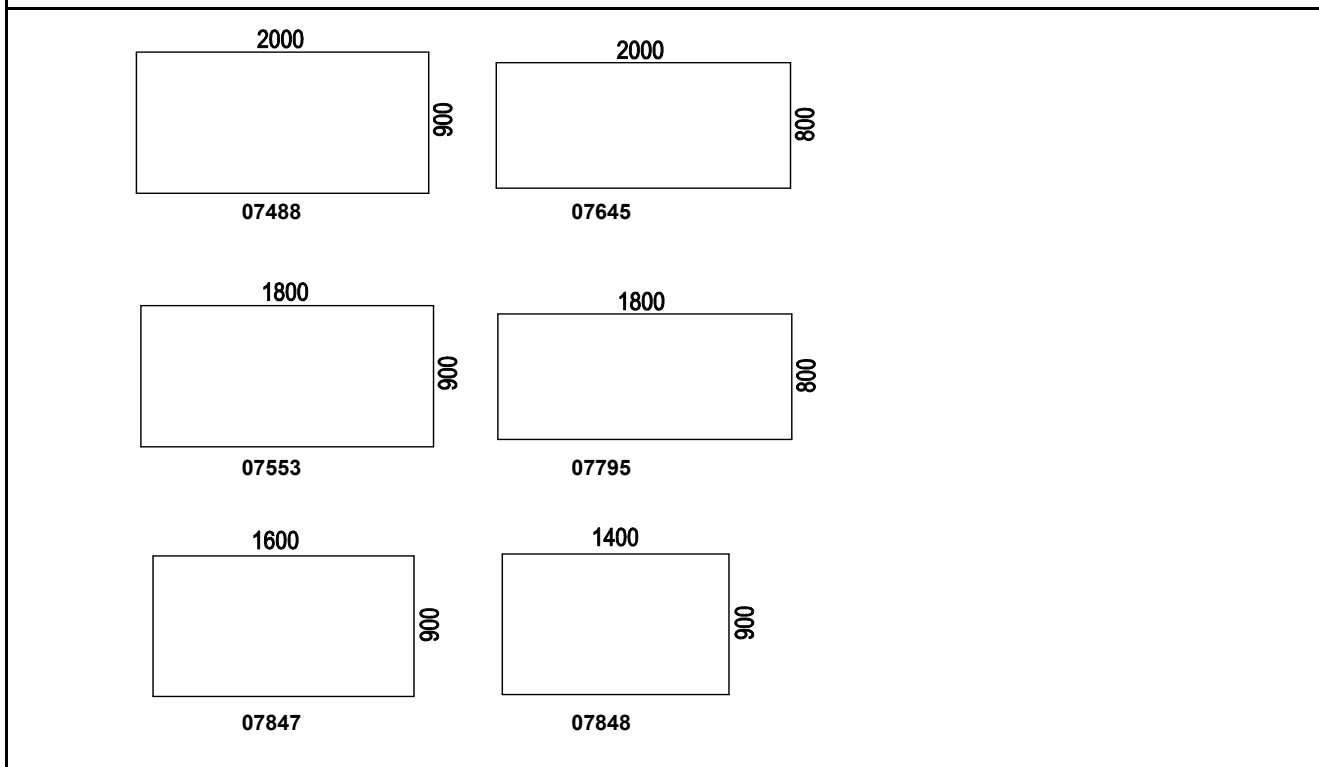



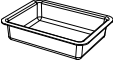





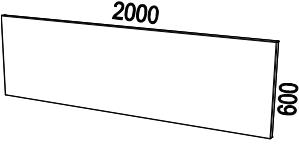
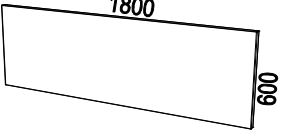
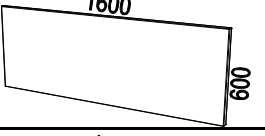
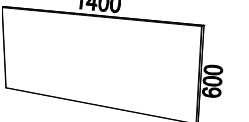
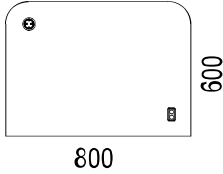
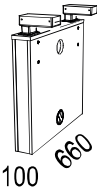
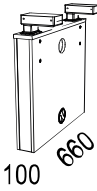
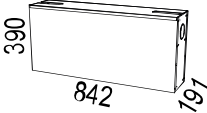
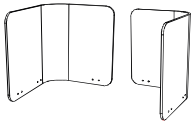
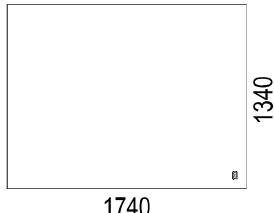


Illustration	Description	Article number	Material	EUR	
A-Frame Design: Anderssen & Voll					
A-Frame ACCESSORIES		RAL colours:			
		31 White	RAL 9016 str		
		37 Black	RAL 9005 str		
	Cable entry including lid 250x150 mm in same material as the desk top. Note: no matching of veneer.	64 31 07438 64 xx 07438 64 xx 07438 64 xx 07438 64 xx 07438	White HPL Optional HPL Linoleum Oak / ash Stained/pigm.	157 157 157 157 157	
	Cable tray in felt 300x220x80 mm	64 98 07403-1	Anthracite	77	
	3-way power outlet, with bracket for above cable tray	34 37 07434	Black	100	
	Shelf in wood , ø 250 mm, höjd 150 mm	64 03 08990 64 D5 08990 64 xx 08990	Oak Hard vax oiled oak Veneer gr 2	274 274 274	
	Shelf in wood, ø 250 mm, incl metal bracket in black or white	64 xxxx 08992 64 xxxx 08992	Hard vax oiled oak Veneer gr 2	264 264	
	Shelf in metal, ø 250 mm, höjd 135 mm	64 31 07430 64 37 07430	White Black	274 274	
	Shelf in metall, ø 250 mm, incl.bracket	64 31 07429 64 37 07429	White Black	264 264	
A-frame SOUND ABSORBING DESK SCREEN					
<ul style="list-style-type: none"> • For mounting in desk top • Thickness approx. 35 mm, of which 30 mm sound absorber • Height over desk: 500 mm • Brackets to be ordered separately • For fabric codes: please see the supplier's website 					
Price group 1:		Price group 2:		Price group 3:	
<u>Camira:</u> Cara, Carlow		<u>Camira:</u> Blazer Lite		<u>Camira:</u> Blazer, Main Line Flax	
<u>Gabriel:</u> Event Screen, Hush		<u>Gabriel:</u> Soul, Soul Mel., Twist, Twist Mel.		<u>Gabriel:</u> Step Melange Screen	
		Focus Melange Screen, Cura Screen		<u>Kvadrat:</u> Remix, Remix Screen, Floyd Screen	
<u>Kvadrat:</u> Hint Screen					
	Sound absorbing desk screen, excluding brackets, length 2000 mm	64 97 82000-x	PG 1 PG 2 PG 3	558 648 721	
	Brackets	34 37 06794-4	black	65	
	Sound absorbing desk screen, excluding brackets, length 1800 mm	64 97 81800-x	PG 1 PG 2 PG 3	493 575 641	
	Brackets	34 37 06794-4	black	65	
	Sound absorbing desk screen, excluding brackets, length 1600 mm	64 97 81600-x	PG 1 PG 2 PG 3	466 540 600	
	Brackets	34 37 06794-4	black	65	
	Sound absorbing desk screen, excluding brackets, length 1400 mm	64 97 81400-x	PG 1 PG 2 PG 3	421 479 550	
	Brackets	34 37 06794-4	black	65	

Illustration	Description	Article number	Material	EUR
<p>Nomono Compact Design: Fredrik Mattson</p>				
<p>Nomono Compact DESK SYSTEM</p> <ul style="list-style-type: none"> Nomono Compact tabletop is made of 19mm MDF with matching edging. Upcharge for veneer edging on laminate tables € 107. Upcharge for veneer edging on linoleum tables € 107- NB: Only oak/ash nature and white pigmented (not stained). Electrically adj. table heigh 70-120cm, anti-collision, 80mm/s lifting speed, 800N lifting force / leg, 0,1W power consumption in standby mode, PVC&PFAS free system, 10 years warranty. Choose the colour of the electric legs and visiible steel and plastic details on legs boxes; black or white. Deskscreen in moulded felt; anthrazite or upholstered. <p><u>Veneer gr 1:</u> Oak (03), Ash (06). <u>Veneer gr 2:</u> White pigm. oak (30), White pigm.ash (10), Black stained ash (86), Dark stained ash (76), Burgundy ash (C8), Conifer ash (D3) Smokey blue ash (D4),Olive ash (D6), Mushroom ash (D7). <u>Vit lam. (HPL):</u> Closest NCS S0502-Y (31) <u>Tillvalslam.(HPL):</u> Light grey 0419 (2A), light grey 1365 (2B), medium grey 1023 (2C), anthracite 1397 (2D), black F2253 (2E) <u>Desktop:</u> 4132 Ash (1B), 4154 Burgundy (1C), 4166 Charcoal (1G), 4172 Mauve (1U), 4174 Conifer (1H), 4175 Pebble (1I), 4176 Mushroom (1J), 4177 Vapour (1K), 4179 Smokey Blue (1M), 4184 Olive (1R).</p>				
	<p>Tabletop 800x600mm R100 rear corner. Including 1 black Powerdot (PM50) and touchpad.</p>	<p>53 xxz 09254H</p>	<p>White lam HPL Optional HPL Linoleum Veneer gr 1 Veneer gr 2</p>	<p>550 601 789 692 692</p>
	<p>Leg box / outer gable 660x610x100mm Incl.electric legs, black or white</p>	<p>53 xxz 09255</p>	<p>White dir.lam. Veneer gr 1 Veneer gr 2</p>	<p>961 1 188 1 188</p>
	<p>Leg box / centre gable 660x610x100mm Incl.electric legs, black or white.</p>	<p>53 xxz 09292</p>	<p>White dir.lam. Veneer gr 1 Veneer gr 2</p>	<p>961 1 188 1 188</p>
	<p>Cable tray 842x390x191mm including 2 x 6way power sockets.</p>	<p>53 xxz 09260</p>	<p>White dir.lam. Veneer gr 1 Veneer gr 2</p>	<p>603 678 678</p>
	<p>Metal cover for cable tray.</p>	<p>53 37 09274 53 31 09274</p>	<p>Black White</p>	<p>81 81</p>
	<p>Desk screen 2 pieces (5309324H+5309324V) including 2 sets of fittings (2x533709312-3), black.</p>		<p>Felt anthrazite Camira Blazer Cami. Blazer Lite Camira Synergy Kvadrat Hero Kv. Hero Heather</p>	<p>508 738 738 800 923 923</p>
	<p>Cable sock ø 20mm in braied textile. Length 1500 mm. With zipper.</p>	<p>32 54 000109 32 54 000101</p>	<p>Black White</p>	<p>40 40</p>

	<p>Meeting table 1740x1340mm. Corner radius 0. Including black touchpad. <i>Equivalent to 4 table tops 800x600, see price examples E, F, and G for placement suggestions</i></p>	<p>53 xxyx A001E</p>	<p>White lam HPL Optional HPL Linoleum Veneer gr 1 Veneer gr 2</p>	<p>1 429 1 516 1 586 1 586</p>
	<p>Project table 1740x600mm. Corner radius 0. Including 1 black Powerdot (PM50) and touchpad. <i>Equivalent to 2 table tops 800x600, see price example D for placement suggestions.</i></p>	<p>53 xxyx A006E</p>	<p>White lam HPL Optional HPL Linoleum Veneer gr 1 Veneer gr 2</p>	<p>976 1 081 1 168 1 185 1 185</p>
	<p>Gable table 1340x900 mm. Corner radius 0. Including black touchpad. <i>Equivalent to 2 table tops 800x600, see price examples H and I for placement suggestions.</i></p>	<p>53 xxyx A007E</p>	<p>White lam HPL Optional HPL Linoleum Veneer gr 1 Veneer gr 2</p>	<p>1 028 1 133 1 185 1 220 1 220</p>

PRICE EXAMPLES

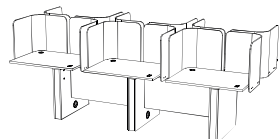
• Below prices are based on white laminate/white direct laminate and screen in moulded felt.

A. 4-grupp with screens



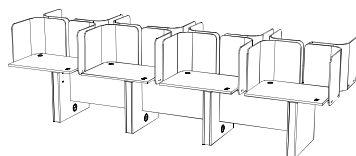
Tabletop 800x600mm	53	xxy	09254H	4	550	2 200
Leg box / outer gable 660x610x100mm	53	xxy	09255	2	961	1 922
Cable tray 842x390x191	53	xxz	09260	1	603	603
Cover for cable tray	53	xx	09274	1	81	81
Screen left, grey moulded felt	53		09324V	4	181	724
Screen right, grey moulded felt	53		09324H	4	181	724
Screen fittings	53	37	09312-3	8	73	584
Total						6 838

B. 6-grupp with screens



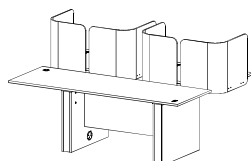
Tabletop 800x600mm	53	xxy	09254H	6	550	3 300
Leg box / outer gable 660x610x100mm	53	xxy	09255	2	961	1 922
Leg box / centre gable 660x610x100mm	53	xxy	09292	1	961	961
Cable tray 842x390x191	53	xxy	09260	2	603	1 206
Cover for cable tray	53	xx	09274	2	81	162
Screen left, grey moulded felt	53		09324V	6	181	1 086
Screen right, grey moulded felt	53		09324H	6	181	1 086
Screen fittings	53	37	09312-3	12	73	876
Total						10 599

C. 8-grupp with screens



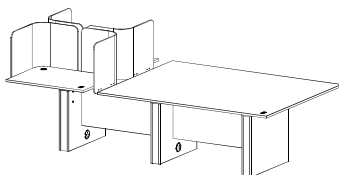
Tabletop 800x600mm	53	xyy	09254H	8	550	4 400
Leg box / outer gable 660x610x100mm	53	xyy	09255	2	961	1 922
Leg box / centre gable 660x610x100mm	53	xyy	09292	2	961	1 922
Cable tray 842x390x191	53	xyy	09260	3	603	1 809
Cover for cable tray	53	xx	09274	3	81	243
Screen left, grey moulded felt	53		09324V	8	181	1 448
Screen right, grey moulded felt	53		09324H	8	181	1 448
Screen fittings	53	37	09312-3	16	73	1 168
Total						14 360

D. Group with 2 work tables and 1 project table



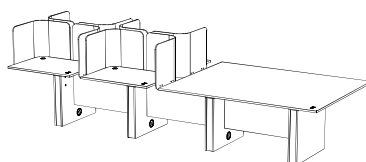
Tabl top 800x600mm	53	xyy	09254H	2	550	1 100
Project table top 1740x600mm	58	xyyx	A006E	1	976	976
Leg box / outer gable 660x610x100mm	53	xyy	09255	2	961	1 922
Cable tray 842x390x191	53	xyy	09260	1	603	603
Cover for cable tray	53	xx	09274	1	81	81
Screen left, grey moulded felt	53		09324V	2	181	362
Screen right, grey moulded felt	53		09324H	2	181	362
Screen fittings	53	37	09312-3	4	73	292
Total						5 698

E. Group with 2 work tables and 1 meeting table



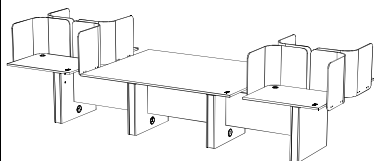
Tabletop 800x600mm	53	xyy	09254H	2	550	1 100
Meeting table top 1740x1340mm	53	xyyx	A001E	1	1429	1 429
Leg box / outer gable 660x610x100mm	53	xyy	09255	2	961	1 922
Leg box / nmiddle gable 660x610x100mm	53	xyy	09292	1	961	961
Cable tray 842x390x191	53	xyy	09260	2	603	1 206
Cover for cable tray	53	xx	09274	2	81	162
Screen left, grey moulded felt	53		09324V	2	181	362
Screen right, grey moulded felt	53		09324H	2	181	362
Screen fittings	53	37	09312-3	4	73	292
Total						7 796

F. Group with 4 work tables and 1 meeting table



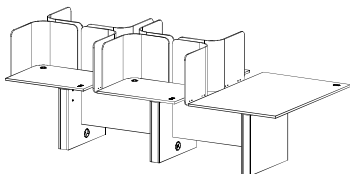
Tabletop 800x600mm	53	xyy	09254H	4	550	2 200
Meeting table top 1740x1340mm	53	xyyx	A001E	1	1429	1 429
Leg box / outer gable 660x610x100mm	53	xyy	09255	2	961	1 922
Leg box / nmiddle gable 660x610x100mm	53	xyy	09292	2	961	1 922
Cable tray 842x390x191	53	xyy	09260	3	603	1 809
Cover for cable tray	53	xx	09274	3	81	243
Screen left, grey moulded felt	53		09324V	4	181	724
Screen right, grey moulded felt	53		09324H	4	181	724
Screen fittings	53	37	09312-3	8	73	584
Total						11 557

G. Group with 4 work tables and 1 meeting table



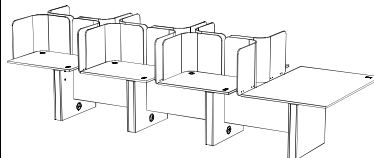
Tabletop 800x600mm	53	xyy	09254H	4	550	2 200
Meeting table top 1740x1340mm	53	xyyx	A001E	1	1429	1 429
Leg box / outer gable 660x610x100mm	53	xyy	09255	2	961	1 922
Leg box / nmiddle gable 660x610x100mm	53	xyy	09292	2	961	1 922
Cable tray 842x390x191	53	xyy	09260	3	603	1 809
Cover for cable tray	53	xx	09274	3	81	243
Screen left, grey moulded felt	53		09324V	4	181	724
Screen right, grey moulded felt	53		09324H	4	181	724
Screen fittings	53	37	09312-3	8	73	584
Total						11 557

H. Group with 4 work tables and 1 gable table

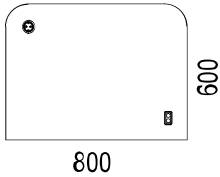
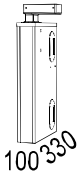
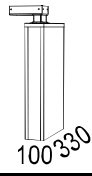
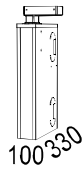
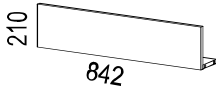
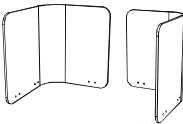
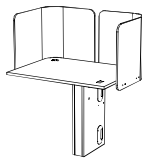


Tabletop 800x600mm	53	xyy	09254H	4	550	2 200
Gable table top 1340x900nn	58	xyyx	A007E	1	1028	1 028
Leg box / outer gable 660x610x100mm	53	xyy	09255	2	961	1 922
Leg box / nmiddle gable 660x610x100mm	53	xyy	09292	1	961	961
Cable tray 842x390x191	53	xyy	09260	2	603	1 206
Cover for cable tray	53	xx	09274	2	81	162
Screen left, grey moulded felt	53		09324V	4	181	724
Screen right, grey moulded felt	53		09324H	4	181	724
Screen fittings	53	37	09312-3	8	73	584
Total						9 511

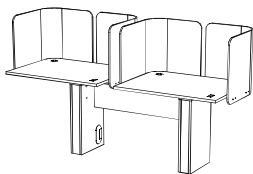
I. Group with 6 work tables and 1 gable table



Tabletop 800x600mm	53	xyy	09254H	6	550	3 300
Gable table top 1340x900nn	58	xyyx	A007E	1	1028	1 028
Leg box / outer gable 660x610x100mm	53	xyy	09255	2	961	1 922
Leg box / nmiddle gable 660x610x100mm	53	xyy	09292	2	961	1 922
Cable tray 842x390x191	53	xyy	09260	3	603	1 809
Cover for cable tray	53	xx	09274	3	81	243
Screen left, grey moulded felt	53		09324V	6	181	1 086
Screen right, grey moulded felt	53		09324H	6	181	1 086
Screen fittings	53	37	09312-3	12	73	876
Total						13 272

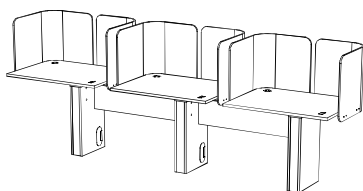
Nomono 1-pillar • For wall mounting only. • Screws for wall mounting not included				
	Tabletop 800x600mm R100 rear corner. Including 1 black Powerdot (PM50) and touchpad.	53 xxz	09254H	White lam HPL 550 Optional HPL 601 Linoleum 789 Veneer gr 1 692 Veneer gr 2 692
	Leg box/outer panel, left, 330x610x100mm. Includes electrical box, black or white.	53 xxz	09590V	White dir.lam. 823 Veneer gr 1 1 048 Veneer gr 2 1 048
	Leg box/outer end panel, right 330x610x100mm. Includes electrical box, black or white.	53 xxz	09590H	White dir.lam. 823 Veneer gr 1 1 048 Veneer gr 2 1 048
	Leg box/center end panel 330x610x100mm. Includes electrical box, black or white.	53 xxz	09590M	White dir.lam. 823 Veneer gr 1 1 048 Veneer gr 2 1 048
	Cable tray 842x210mm, incl. 6-power outlet. Used when there are several 1-pillars in a row.	53 xxz	09592	White dir.lam. 350 Veneer gr 1 371 Veneer gr 2 371
	Desk screen 2 pieces (5309324H+5309324V) including 2 sets of fittings (2x533709312-3), black.			Felt anthrazite 508 Camira Blazer 738 Cami. Blazer Lite 738 Camira Synergy 800 Kvadrat Hero 923 Kv. Hero Heather 923
	Cable sock ø 20mm in braided textile. Length 1500 mm. With zipper.	32	54 000109	Black 40
		32	54 000101	White 40
PRICE EXAMPLES • Below prices are based on white laminate/white direct laminate and screen in moulded felt.				
J. 1-pillar with screen				
	Tabletop 800x600mm	53	xyy 09254V	1 550 550
	Leg box/outer end left 330x610x100mm	53	xyy 09590M	1 823 823
	Screen left, gray molded felt	53	09324V	1 181 181
	Screen right, gray molded felt	53	09324H	1 181 181
	Screen fittings	53	37 09312-3	2 73 146
	Total			1 881

K. 2 x 1-pillars with screens



Tabletop 800x600mm	53	xyy	09254H	2	550	1 100
Leg box/outer end left 330x610x100mm	53	xyy	09590V	1	823	823
Leg box/outer end right 330x610x100mm	53	xyy	09590H	1	823	823
Cable duct 842x390x191	53	xyy	09592	1	350	350
Screen left, gray molded felt	53		09324V	2	181	362
Screen right, gray molded felt	53		09324H	2	181	362
Screen fittings	53	37	09312-3	4	73	292
Total						4 112

L. 3 x 1-pillars with screens



Tabletop 800x600mm	53	xyy	09254H	3	550	1 650
Leg box/outer end left 330x610x100mm	53	xyy	09590V	1	823	823
Leg box/centre end 330x610x100mm	53	xyy	09590M	1	823	823
Leg box/outer end right 330x610x100mm	53	xyy	09590H	1	823	823
Cable duct 842x390x191	53	xyy	09592	2	350	700
Left screen, grey moulded felt	53		09324V	3	181	543
Right screen, grey moulded felt	53		09324H	3	181	543
Screen fittings	53	37	09312-3	6	73	438
Total						6 343

Nomono



NOMONO is specially designed to work in open plan offices. Its clear and firm horizontal tables calms down an environment can sometimes be perceived as a bit chaotic with the desktop screens at different altitudes. The legs have covered sides to further tidy up the office.

In Nomono there are integrated cable boxes that hide the cable clutter that usually occurs in an office. The box is handy for laptop, ipod or phone charger. It can also be equipped with a USB or other technology that connects the office.

Nomono has also another type of leg, a more classic height-adjustable leg, we call it Nomono T. Everything to make it possible to use Nomono in all kinds of environments and offices.

It is important that the workplace may look different. You can choose the accessories you want and color after taste or to suit the corporate image.

Nomono is truly worked out in every detail. A reliable, highly competent and attractive fellow worker.

Design: Fredrik Mattson

5520

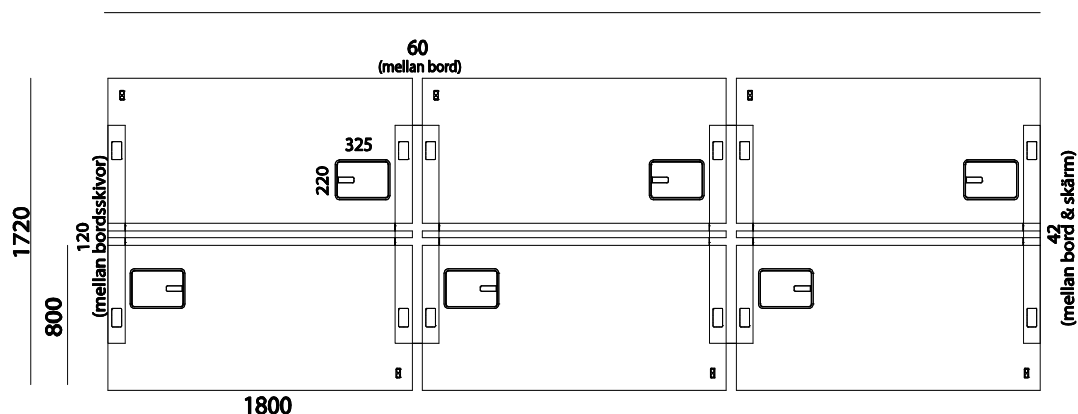


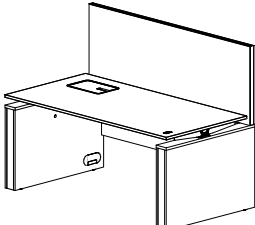
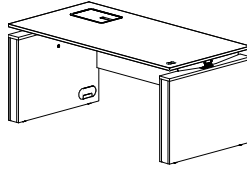
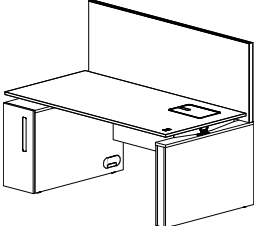
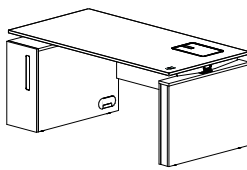
Illustration	Description	Article number	Pcs	Price /pce	EUR	
Nomono Design: Fredrik Mattson						
Nomono ARRANGEMENTS						
<p>• We have in the examples below made use of tabletops 1800x800 mm in white laminate. If you choose a different size of desk top, please make sure to adjust to correct size of desk screen, cable etc as well.</p>						
A. <u>Single desk</u>						
	Tabletop 1800x800	53 31	5303SEK	1	876	876
	Gable 880x100 mm	53 31	W2500V/H	2	1118	2 236
	Desk screen, fabric in price group 1	34 97	06632-x	1	450	450
	Screen brackets	53 37	01069	1	130	130
	Cable box	53 31	5300xx	1	302	302
	Front panel	53 31	80184	1	272	272
	Cable tray	53 31	03790-2	1	244	244
	Total					4 510
B. <u>Single desk</u>						
	Tabletop 1800x800	53 31	5303SEK	1	876	876
	Gable 800x100 mm	53 31	W02445V/H	2	1058	2 116
	Cable box	53 31	5300xx	1	302	302
	Front panel	53 31	80184	1	272	272
	Cable tray	53 31	03790-2	1	244	244
	Total					3 810
C. <u>Singelplats med boxförvaring</u>						
	Tabletop 1800x800	53 31	5322SEK	1	876	876
	Gable 880x100 mm, right	53 31	W02500H	1	1118	1 118
	Gable 880x300 with storage, left	53 31xx	W02505V	1	1541	1 541
	Desk screen, fabric in price group 1	34 97	06632-x	1	450	450
	Screen brackets	53 37	01069	1	130	130
	Cable box	53 31	5300xx	1	302	302
	Cable tray	53 31	03790-2	1	244	244
	Total					4 661
D. <u>Single desk with storage</u>						
	Tabletop 1800x800	53 31	5322SEK	1	1032	1 032
	Gable 800x100 mm, right	53 31	W02445H	1	876	876
	Gable 800x300 with storage, left	53 31xx	W02450V	1	1480	1 480
	Cable box	53 31	5300xx	1	302	302
	Cable tray	53 31	03790-2	1	244	244
	Total					3 934

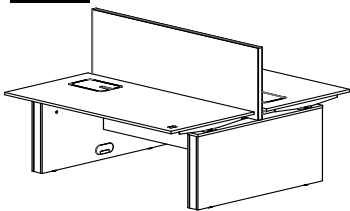
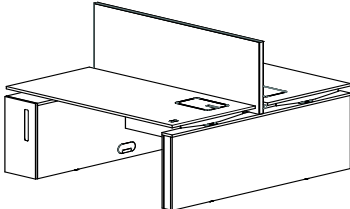
Illustration	Description	Article number	Pcs	Price /pce	EUR
E. 2-group					
					
	Tabletop 1800x800	53 31 5303SEK	2	876	1 752
	Gable 1200x100 mm	53 31 W02460	2	1571	3 142
	Desk screen, fabric in price group 1	34 97 06632-x	1	450	450
	Screen brackets	53 37 01069	1	130	130
	Cable tray	53 31 03790-4	1	292	292
	Cable box	53 31 5300xx	2	302	604
	Mittpanel	53 31 02490-3	1	174	174
	Total				6 544
F. 2-group with storage					
					
	Tabletop 1800x800	53 31 5303SEK	1	876	876
	Tabletop1800x800	53 31 5322SEK	1	876	876
	Gable 1720x100 mm	53 31 W02470	1	1601	1 601
	Gable 1720x300 mm with storage	53 31xx W02485	1	2297	2 297
	Desk screen, fabric in price group 1	34 97 06632-x	1	450	450
	Screen brackets	53 37 01069	1	130	130
	Cable tray	53 31 03790-4	1	292	292
	Cable box	53 31 5300xx	2	302	604
	Total				7 126

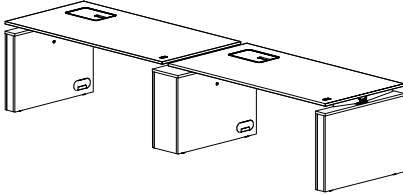
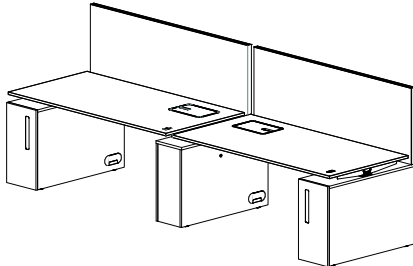
Illustration	Description	Article number	Pcs	Price /pce	EUR
G1. 2-group side by side					
					
	Tabletop 1800x800	53 31 5303SEK	2	876	1 752
	Gable 800x100 mm	53 31 W02445V/H	2	1058	2 116
	Gable 800x260 mm	53 31 W02455	1	1571	1 571
	Cable box	53 31 5300xx	2	302	604
	Cable tray	53 31 03790-2	2	244	488
	Total				6 531
G2. 2-group side by side with storage					
					
	Tabletop1800x800	53 31 5303SEK	1	876	876
	Tabletop 1800x800	53 31 5322SEK	1	876	876
	Gable 880x300 with storage	53 31 W02505V/H	2	1541	3 082
	Gable 880x260 mm	53 31 W03075	1	1632	1 632
	Desk screen, fabric in price group 1	34 97 06632-x	2	450	900
	Screen brackets	53 37 01069	2	130	260
	Cable box	53 31 5300xx	2	302	604
	Cable tray	53 31 03790-2	2	244	488
	Total				8 718

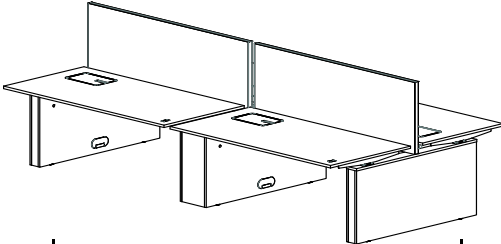
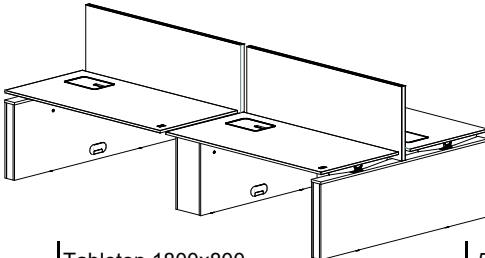
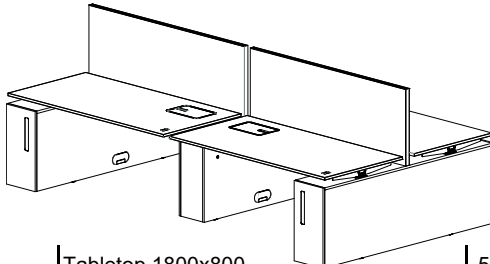
Illustration	Description	Article number	Pcs	Price /pce	EUR
H. 4-group (with gables 1200 mm)					
					
	Tabletop 1800x800	53 31 5303SEK	4	876	3 504
	Gable 1200x100 mm	53 31 W02460	2	1571	3 142
	Gable 1200x260 mm	53 31 W02465	1	2387	2 387
	Desk screen, fabric in price group 1	34 97 06632-x	2	450	900
	Screen brackets	53 37 01069	2	130	260
	Cable tray	53 31 03790-4	2	292	584
	Cable box	53 31 5300xx	4	302	1 208
	Total				11 985
I. 4-group (with outer gables 1720 mm)					
					
	Tabletop 1800x800	53 31 5303SEK	4	876	3 504
	Gable 1720x100	53 31 W02470	2	1601	3 202
	Gable 1200x260 mm	53 31 W02465	1	2387	2 387
	Desk screen, fabric in price group 1	34 97 06632-x	2	450	900
	Screen brackets	53 37 01069	2	130	260
	Cable tray	53 31 03790-4	2	292	584
	Cable box	53 31 5300xx	4	302	1 208
	Total				12 045
J. 4-grup with storage					
					
	Tabletop 1800x800	53 31 5303SEK	2	876	1 752
	Tabletop 1800x800	53 31 5322SEK	2	876	1 752
	Gable 1720x300 with storage	53 31xx W02485	2	2297	4 594
	Gable 1200x260	53 31 W02465	1	2387	2 387
	Desk screen, fabric in price group 1	34 97 06632-x	2	450	900
	Screen brackets	53 37 01069	2	130	260
	Cable tray	53 31 03790-4	2	292	584
	Cable box	53 31 5300xx	4	302	1 208
	Total				13 437

Illustration	Description	Article number	Pcs	Price /pce	EUR
K. 6-group					
	Tabletop 1800x800	53 31 5303SEK	6	876	5 256
	Gable 1200x100 mm	53 31 W02460	2	1571	3 142
	Gable 1200x260 mm	53 31 W02465	2	2387	4 774
	Desk screen, fabric in price group 1	34 97 06632-x	3	450	1 350
	Screen brackets	53 37 01069	3	130	390
	Cable tray	53 31 03790-4	3	292	876
	Cable box	53 31 5300xx	6	302	1 812
	Total				17 600



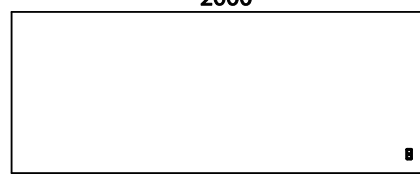
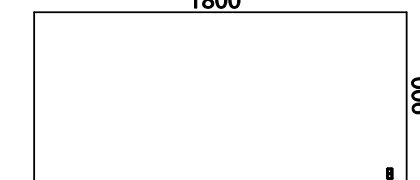
Illustration	Description	Article number	Material	EUR		
<p>Nomono Design: Fredrik Mattson </p>						
<p>Nomono DESK TOPS</p> <ul style="list-style-type: none"> • Nomono tabletops are made of 19 mm MDF. Radius 0. • Gables not included in below prices. Order separately. • Price for cable lid is not included in below prices. Order separately. • For additional product information: please see www.horreds.se <p><u>White HPL:</u> closest NCS S0502-Y <u>Optional HPL:</u> Light grey, medium grey, anthracite and black. <u>Linoleum:</u> 4132 Ash, 4154 Burgundy, 4166 Charcoal, 4172 Mauve, 4174 Conifer, 4175 Pebble, 4176 Mushroom, 4177 Vapour, 4179 Smokey Blue, 4184 Olive. <u>Veneer gr 1:</u> Oak (03) / Ash (06) <u>Veneer gr 2:</u> White pigmented Oak (30), White pigmented Ash (10), Black stained Ash (86), Dark stained Ash (76), Burgundy ash (C8), Conifer ash (D3), Smokey Blue ash (D4), Olive ash (D6), Mushroom ash (D7).</p>						
	Tabletop 2000x900 mm. Including touchpad, frame and trafo. Prepared for cable box left side	53 31 5306SEK 53 xx 5306SEK 53 xx 5306SEK 53 xx 5306SEK 53 xx 5306SEK	White HPL Optional HPL Linoleum Veneer group 1 Veneer group 2	876 1 099 907 1 025 1 025		
	Tabletop 2000x900 mm. Including touchpad, frame and trafo. Prepared for cable box right side	53 31 5321SEK 53 xx 5321SEK 53 xx 5321SEK 53 xx 5321SEK 53 xx 5321SEK	White HPL Optional HPL Linoleum Veneer group 1 Veneer group 2	876 1 099 907 1 025 1 025		
		Tabletop 2000x800 mm. Including touchpad, frame and trafo. Prepared for cable box left side	53 31 5305SEK 53 xx 5305SEK 53 xx 5305SEK 53 xx 5305SEK	White HPL Optional HPL Linoleum Veneer group 1 Veneer group 2	876 1 099 907 1 025 1 025	
		Tabletop 2000x800 mm. Including touchpad, frame and trafo. Prepared for cable box right side	53 31 5324SEK 53 xx 5324SEK 53 xx 5324SEK 53 xx 5324SEK 53 xx 5324SEK	White HPL Optional HPL Linoleum Veneer group 1 Veneer group 2	876 1 099 907 1 025 1 025	
			Tabletop 1800x900 mm. Including touchpad, frame and trafo. Prepared for cable box left side	53 31 5304SEK 53 xx 5304SEK 53 xx 5304SEK 53 xx 5304SEK	White HPL Optional HPL Linoleum Veneer group 1 Veneer group 2	876 1 099 907 1 025 1 025
			Tabletop 1800x900 mm. Including touchpad, frame and trafo. Prepared for cable box right side	53 31 5318SEK 53 xx 5318SEK 53 xx 5318SEK 53 xx 5318SEK 53 xx 5318SEK	White HPL Optional HPL Linoleum Veneer group 1 Veneer group 2	876 1 099 907 1 025 1 025





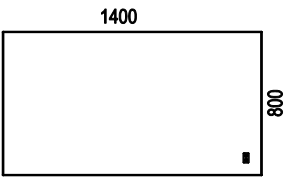
Illustration	Description	Article number	Material	EUR	
	Tabletop 1800x800 mm.	53 31 5303SEK	White HPL	876	
	Including touchpad, frame and trafo.	53 xx 5303SEK	Optional HPL	1 099	
	Prepared for cable box left side	53 xx 5303SEK	Linoleum	907	
		53 xx 5303SEK	Veneer group 1	1 025	
		53 xx 5303SEK	Veneer group 2	1 025	
	Tabletop 1800x800 mm.	53 31 5322SEK	White HPL	876	
	Including touchpad, frame and trafo.	53 xx 5322SEK	Optional HPL	1 099	
	Prepared for cable box right side	53 xx 5322SEK	Linoleum	907	
		53 xx 5322SEK	Veneer group 1	1 025	
		53 xx 5322SEK	Veneer group 2	1 025	
		Tabletop 1600x900 mm.	53 31 5302SEK	White HPL	876
		Including touchpad, frame and trafo.	53 xx 5302SEK	Optional HPL	1 099
Prepared for cable box left side		53 xx 5302SEK	Linoleum	907	
		53 xx 5302SEK	Veneer group 1	1 025	
		53 xx 5302SEK	Veneer group 2	1 025	
Tabletop 1600x900 mm.		53 31 5320SEK	White HPL	876	
Including touchpad, frame and trafo.		53 xx 5320SEK	Optional HPL	1 099	
Prepared for cable box right side		53 xx 5320SEK	Linoleum	907	
		53 xx 5320SEK	Veneer group 1	1 025	
		53 xx 5320SEK	Veneer group 2	1 025	
		Tabletop 1600x800 mm.	53 31 5301SEK	White HPL	808
		Including touchpad, frame and trafo.	53 xx 5301SEK	Optional HPL	1 061
	Prepared for cable box left side	53 xx 5301SEK	Linoleum	872	
		53 xx 5301SEK	Veneer group 1	967	
		53 xx 5301SEK	Veneer group 2	967	
	Tabletop 1600x800 mm.	53 31 5323SEK	White HPL	808	
	Including touchpad, frame and trafo.	53 xx 5323SEK	Optional HPL	1 061	
	Prepared for cable box right side	53 xx 5323SEK	Linoleum	872	
		53 xx 5323SEK	Veneer group 1	967	
		53 xx 5323SEK	Veneer group 2	967	
		Tabletop 1400x900 mm.	53 31 5311SEK	White HPL	876
		Including touchpad, frame and trafo.	53 xx 5311SEK	Optional HPL	1 099
Prepared for cable box left side		53 xx 5311SEK	Linoleum	907	
		53 xx 5311SEK	Veneer group 1	1 025	
		53 xx 5311SEK	Veneer group 2	1 025	
Tabletop 1400x900 mm.		53 31 5339SEK	White HPL	876	
Including touchpad, frame and trafo.		53 xx 5339SEK	Optional HPL	1 099	
Prepared for cable box right side		53 xx 5339SEK	Linoleum	907	
		53 xx 5339SEK	Veneer group 1	1 025	
		53 xx 5339SEK	Veneer group 2	1 025	

Illustration	Description	Article number	Material	EUR
	Tabletop 1400x800 mm. Including touchpad, frame and trafo. Prepared for cable box left side	53 31 5312SEK	White HPL	808
		53 xx 5312SEK	Optional HPL	1 061
		53 xx 5312SEK	Linoleum	872
		53 xx 5312SEK	Veneer group 1	967
		53 xx 5312SEK	Veneer group 2	967
	Tabletop 1400x800 mm. Including touchpad, frame and trafo. Prepared for cable box right side	53 31 5338SEK	White HPL	808
		53 xx 5338SEK	Optional HPL	1 061
		53 xx 5338SEK	Linoleum	872
		53 xx 5338SEK	Veneer group 1	967
		53 xx 5338SEK	Veneer group 2	967

Nomono GABLES

Color handles / closest NCS:

- Including electrical legs, adjustable 73-120 cm
- Lifting force 800N/leg, anti-collision, 0,1W power consumption in standby mode, 5 years warranty.
- Height from floor to top of gable: 618 mm
- Veneer group 1: Oak (03) / Ash (06)
- Veneer group 2: white oak (30), black ash (86), white ash (10), dark ash (76) Burgundy ash(C8) Conifer Ash (D3), Smokey Blue ash (D4). Olive ash (D6), Mushroom ash (D7).
- Options:
 - Gable door with lock: additional € 65 / door
 - Cable hole outer side of gable: additional € 92 / gable
 - Handles in Elmosoft 54035 Light Brown € 35:- / handle

- 31** White S 0300-N
- 37** Black S 9000-N
- 32** Yellow S 1070-Y
- 36** Green S 2570-G30Y
- 33** Red S 1580-Y80R
- 35** Turquoise S0540-B30G
- 42** Orange S 1080-Y50R

Depth 800 mm - for single desk without desk screen

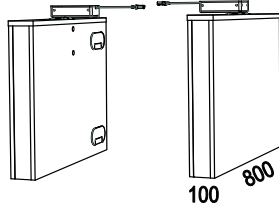
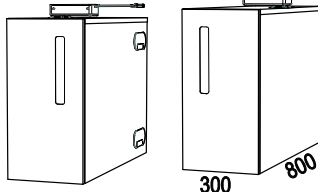
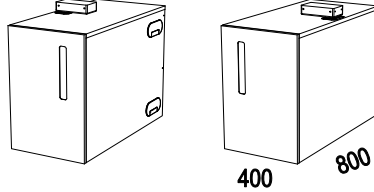
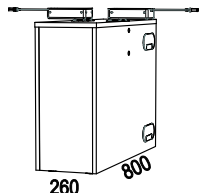
	Gable 800x100, left	53 31W 02445V	White dir.laminate	1 058
		53 xxX 02445V	Veneer group 1	1 511
		53 xxX 02445V	Veneer group 2	1 511
	Gable 800x100, right	53 31W 02445H	White dir.laminate	1 058
		53 xxX 02445H	Veneer group 1	1 511
		53 xxX 02445H	Veneer group 2	1 511
	Gable 800x300 mm, left, with storage	53 31Wxx 02450V	White dir.laminate	1 480
		53 xxXxx 02450V	Veneer group 1	2 357
		53 xxXxx 02450V	Veneer group 2	2 357
	Gable 800x300 mm, right, with storage	53 31Wxx 02450H	White dir.laminate	1 480
		53 xxXxx 02450H	Veneer group 1	2 357
		53 xxXxx 02450H	Veneer group 2	2 357
	Gable 800x400 mm, left, with withdrawable storage	53 31Wxx 03330V	White dir.laminate	2 236
		53 xxXxx 03330V	Veneer group 1	2 901
		53 xxXxx 03330V	Veneer group 2	2 901
	Gable 800x400 mm, right with withdrawable storage	53 31Wxx 03330H	White dir.laminate	2 236
		53 xxXxx 03330H	Veneer group 1	2 901
		53 xxXxx 03330H	Veneer group 2	2 901
	Gable, middle, 800x260 mm	53 31W 02455	White dir.laminate	1 571
		53 xxX 02455	Veneer group 1	2 055
		53 xxX 02455	Veneer group 2	2 055

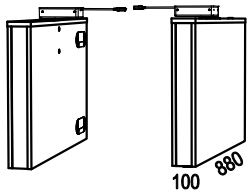
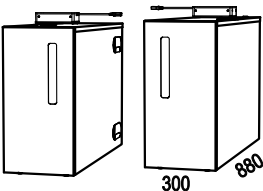
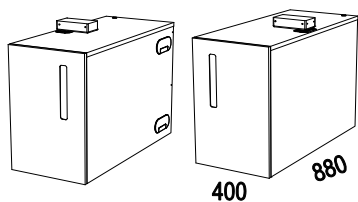
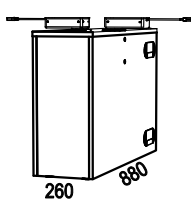
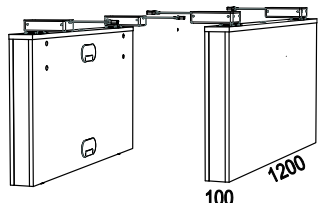
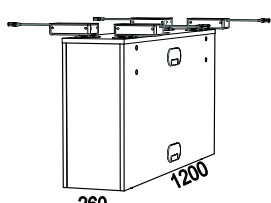
Illustration	Description	Article number	Material	EUR	
Depth 880 mm - for single desk with desk screen					
	Gable 880x100 mm, left	53 31W 02500V 53 xxX 02500V 53 xxX 02500V	White dir.laminate Veneer group 1 Veneer group 2	1 118 1 632 1 632	
	Gable 880x100 mm, right	53 31W 02500H 53 xxX 02500H 53 xxX 02500H	White dir.laminate Veneer group 1 Veneer group 2	1 118 1 632 1 632	
		Gable 880x300 mm, left, with storage	53 31Wxx 02505V 53 xxXxx 02505V 53 xxXxx 02505V	White dir.laminate Veneer group 1 Veneer group 2	1 541 2 478 2 478
		Gable 880x300 mm, right with storage	53 31Wxx 02505H 53 xxXxx 02505H 53 xxXxx 02505H	White dir.laminate Veneer group 1 Veneer group 2	1 541 2 478 2 478
			Gable 880x400 mm, left, with withdrawable storage	53 31Wxx 03955V 53 xxXxx 03955V 53 xxXxx 03955V	White dir.laminate Veneer group 1 Veneer group 2
	Gable 880x400 mm, right, with withdrawable storage		53 31Wxx 03955H 53 xxXxx 03955H 53 xxXxx 03955H	White dir.laminate Veneer group 1 Veneer group 2	2 297 3 022 3 022
	Gable, middle, 880x260 mm		53 31W 03075 53 xxX 03075 53 xxX 03075	White dir.laminate Veneer group 1 Veneer group 2	1 632 2 176 2 176
	Depth 1200 mm				
		Gable 1200x100 mm.	53 31W 02460 53 xxX 02460 53 xxX 02460	White dir.laminate Veneer group 1 Veneer group 2	1 571 2 085 2 085
		Gable, middle, 1200x260 mm.	53 31W 02465 53 xxX 02465 53 xxX 02465	White dir.laminate Veneer group 1 Veneer group 2	2 387 2 901 2 901

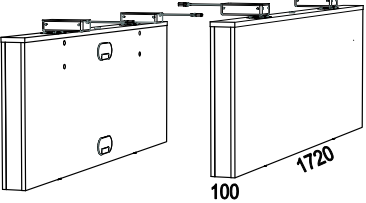
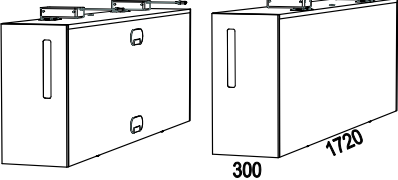
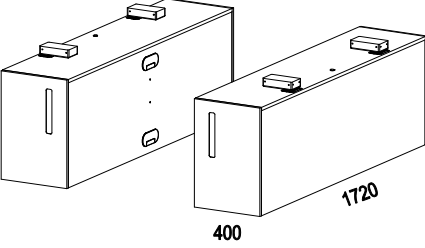
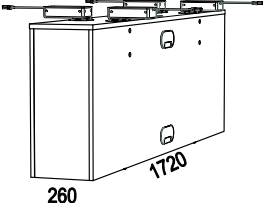
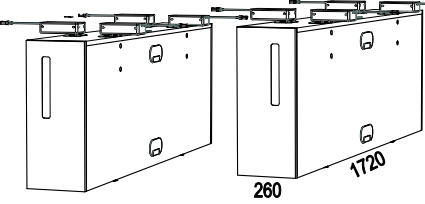
Illustration	Description	Article number	Material	EUR
Depth 1720 mm				
	Gable 1720x100 mm	53 31W 02470 53 xxX 02470 53 xxX 02470	White dir.laminate Veneer group 1 Veneer group 2	1 601 2 115 2 115
	Gable 1720x300 mm, with storage	53 31Wxx 02485 53 xxXxx 02485 53 xxXxx 02485	White dir.laminate Veneer group 1 Veneer group 2	2 297 3 626 3 626
	Gable, 1720x400 mm, with withdrawable storage	53 31Wxx 04024 53 xxXxx 04024 53 xxXxx 04024	White dir.laminate Veneer group 1 Veneer group 2	3 868 4 593 4 593
	Gable, middle, 1720x260 mm	53 31W 02475 53 xxX 02475 53 xxX 02475	White dir.laminate Veneer group 1 Veneer group 2	2 538 3 143 3 143
	Gable, middle, 1720x260 mm, with storage	53 31Wxx 02480 53 xxXxx 02480 53 xxXxx 02480	White dir.laminate Veneer group 1 Veneer group 2	3 173 4 532 4 532


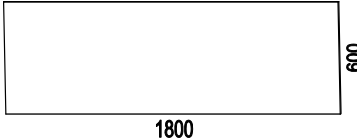
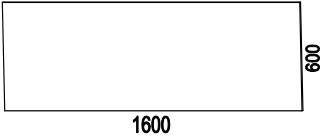
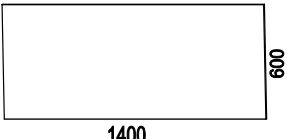

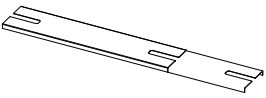

Illustration	Description	Article number	Material	EUR	
<p>Nomono SOUND ABSORBING DESK SCREENS</p> <ul style="list-style-type: none"> • For mounting in gables • Thickness approx.35 mm, of which 30 mm sound absorber • Fixed height from floor: 120 cm. • Brackets to be ordered separately • For fabric codes: please see the supplier's website 					
<p>Price group 1:</p> <p><u>Camira:</u> Cara, Carlow</p> <p><u>Gabriel:</u> Event Screen, Hush</p>		<p>Price group 2:</p> <p><u>Camira:</u> Blazer Lite</p> <p><u>Gabriel:</u> Soul, Soul Mel., Twist, Twist Mel.</p> <p>Focus Melange Screen, Cura Screen</p> <p><u>Kvadrat:</u> Hint Screen</p>		<p>Price group 3:</p> <p><u>Camira:</u> Blazer, Main Line Flax</p> <p><u>Gabriel:</u> Step Melange Screen</p> <p><u>Kvadrat:</u> Remix, Remix Screen, Floyd Screen</p>	
	<p>Sound absorbing desk screen, excluding brackets, length 2000 mm</p> <p>Brackets</p>	<p>34 97 04230-x</p> <p>53 37 01069</p>	<p>PG 1</p> <p>PG 2</p> <p>PG 3</p>	<p>540</p> <p>637</p> <p>721</p> <p>130</p>	
	<p>Sound absorbing desk screen, excluding brackets, length 1800 mm</p> <p>Brackets</p>	<p>34 97 06632-x</p> <p>53 37 01069</p>	<p>PG 1</p> <p>PG 2</p> <p>PG 3</p>	<p>450</p> <p>531</p> <p>601</p> <p>130</p>	
	<p>Sound absorbing desk screen, excluding brackets, length 1600 mm</p> <p>Brackets</p>	<p>34 97 04207-x</p> <p>53 37 01069</p>	<p>PG 1</p> <p>PG 2</p> <p>PG 3</p>	<p>388</p> <p>444</p> <p>544</p> <p>130</p>	
	<p>Sound absorbing desk screen, excluding brackets, length 1400 mm</p> <p>Brackets</p>	<p>34 97 07052-x</p> <p>53 37 01069</p>	<p>PG 1</p> <p>PG 2</p> <p>PG 3</p>	<p>378</p> <p>433</p> <p>506</p> <p>130</p>	

Illustration	Description	Article number	Material	EUR
Nomono FRONT PANELS • Required for single desks with gables without storage in order to obtain sufficient stability. • For single desks with storage the front panels are optional.				
	Front panel 1802x350 mm. For desk: 2000 mm with gables without storage	53 31 80204	White dir.laminate	272
		53 xx 80204	Veneer group 1	423
		53 xx 80204	Veneer group 2	423
	Front panel 1602x350 mm. For desks: 1800 mm with gables without storage 2000 mm with gable storage one side	53 31 80184	White dir.laminate	272
		53 xx 80184	Veneer group 1	423
		53 xx 80184	Veneer group 2	423
	Front panel 1502x350 mm. For desk: 2000 mm with gable with withdrawable storage one side	53 31 80205	White dir.laminate	272
		53 xx 80205	Veneer group 1	423
		53 xx 80205	Veneer group 2	423
	Front panel 1402x350 mm. For desks: 1600 mm with gables without storage 1800 mm with gable w.storage one side	53 31 80164	White dir.laminate	272
		53 xx 80164	Veneer group 1	423
		53 xx 80164	Veneer group 2	423
	Front panel 1302x350 mm. For desk: 1800 mm with gable with withdrawable storage one side	53 31 80185	White dir.laminate	272
		53 xx 80185	Veneer group 1	423
		53 xx 80185	Veneer group 2	423
	Front panel 1202x350 mm. For desks: 1400 mm with gables without storage 1600 mm with gable storage one side	53 31 80144	White dir.laminate	272
		53 xx 80144	Veneer group 1	423
		53 xx 80144	Veneer group 2	423
	Front panel 1102x350 mm. For desk: 1600 mm with gable with withdrawable storage one side	53 31 80165	White dir.laminate	272
		53 xx 80165	Veneer group 1	423
		53 xx 80165	Veneer group 2	423
	Front panel 1002x350 mm. For desk: 1400 mm with gable storage one side	53 31 80124	White dir.laminate	272
		53 xx 80124	Veneer group 1	423
		53 xx 80124	Veneer group 2	423
Nomono MIDDLE PANELS • Required for 2-groups (desks placed opposite each other) with gables without storage in order to obtain sufficient stability.				
	Middle panel 1802x200 mm. For desk 2000 mm with gables without storage	53 31 02490-4	White dir.laminate	174
		53 xx 02490-4	Veneer group 1	270
		53 xx 02490-4	Veneer group 2	270
	Middle panel 1602x200 mm. For desk 1800 mm with gables without storage	53 31 02490-3	White dir.laminate	174
		53 73 02490-3	Veneer group 1	270
		53 xx 02490-3	Veneer group 2	270
	Middle panel 1402x200 mm. For desk 1600 mm with gables without storage	53 31 02490-2	White dir.laminate	174
		53 73 02490-2	Veneer group 1	270
		53 xx 02490-2	Veneer group 2	270
	Middle panel 1202x200 mm. For desk 1400 mm with gables without storage	53 31 02490-1	White dir.laminate	174
		53 73 02490-1	Veneer group 1	270
		53 xx 02490-1	Veneer group 2	270

Illustration	Description	Article number	Material	EUR	
<p>Nomono CABLE TRAYS</p> <p>• Flexible cable tray for mounting in gables</p> <p style="text-align: right;">31 White RAL 9016 37 Black RAL 9005</p>					
	Flexible cable tray to single desks and groups side by side. Incl 2xpower 1 cable tray/desk is required.	53 31 03790-2 53 37 03790-2	White Black	244 244	
	Flexible cable tray for groups with 2 desks opposite each other. Ink'cl. 4xpower. 1 cable tray/2 desks is required.	53 31 03790-4 53 37 03790-4	White Black	292 292	
	<i>Not suitable to desk length 1400 mm with withdrawable gable.</i>				
		Lid for flexible cable tray	53 31 03792 53 37 03792	White Black	93 93
		<p>Nomono CABLE LID</p> <p>• Cable lid made of the same material as the desk top, with MDF edges.</p>			
		Extra cost for shutter on desk top. Incl. Plastic box (black or white) and 3-way standard socket and cable pipe in textile-	53 31 5300xx 53 xx 5300xx 53 xx 5300xx 53 xx 5300xx 53 xx 5300xx	White HPL Optional HPL Linoleum Veneer group 1 Veneer group 2	302 302 302 302 302

Nomono T Design: Fredrik Mattson

NOMONO T WORK DESKS



- Choose tabletop from format B or E.
- Complete prices including desk top, frame and electrical T-legs.
- Nomono T tabletops are made of 19 mm MDF with straight edge.
- Height adjustment control (touch pad) always on the right side of the desk top.
- Radius 0.
- Shape rectangular
- The cable box is always placed on the left side of the desk top.

• **Desktop from Forbo Flooring:**

4132 Ash	5502-G
4154 Burgundy	7010-R10B
4166 Charcoal	8502-B
4172 Mauve	7005-Y80R
4174 Conifer	8010-B90G
4175 Pebble	3502-Y
4176 Mushroom	2002-Y
4177 Vapour	2005-G10Y
4179 Smokey Blue	7010-R90B
4184 Olive	5010-G50Y

• **Veneer group 1:**

- Oak nature (03)
- Ash nature (06)

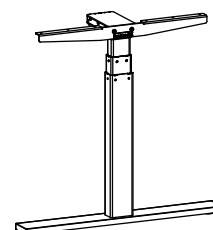
• **Veneer group 2:**

- White pigmented oak (30)
- Black stained ash (86)
- White pigmented ash (10)
- Dark ash (76)
- Burgundy ash (C8)
- Conifer ash (D3)
- Smokey Blue ash (D4)
- Olive ash (D6)
- Mushroom ash (D7)

• **High Pressure Laminate:**

	Closest NCS:
White HPL (lam0754)	S0502-Y
Light grey HPL (optional lam 0419)	S2002-Y
Light grey HPL (optional lam 1365)	S2005-R80B
Medium grey HPL (opt. Lam 1023)	S5500-N
Anthracite HPL (opt. lam 1397)	S7500-N
Black HPL (optional lam 2253)	S9000-N

- Electrical T-leg with anti-collision-solution
- Lifting speed 80mm/s, lifting force 800N/leg
- Power consumption in standby mode: 0,1W
- PFAS and PVC free
- 10 years warranty
- Massive feet
- For additional product information: please see www.horreds.se



Nomono T Design: Fredrik Mattson

B

Desks within size 2000x900 mm

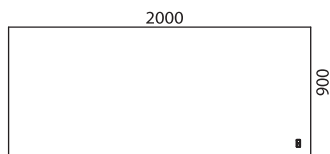
Complete package with tabletop, frame and electrical T-legs.

Please replace the first 2 xx in the article number with the material code for the desk top.
Next 4 xxxx should be replaced with the code for the desk (the code under the desk symbol)

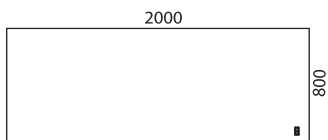
	Colour stand	Article number	White laminate (HPL)	Optional laminate (HPL)	Lineoleum	Veneer group 1	Veneer group 2
Tabletop incl electrical T-legs (61-126 cm)	White	53B xx xxxxx 31-E	1 730	1 953	1 761	1 879	1 879
	Black	53B xx xxxxx 37-E	1 730	1 953	1 761	1 879	1 879
Desk top only		53B xx xxxxE	388	611	419	537	537

OPTIONS:

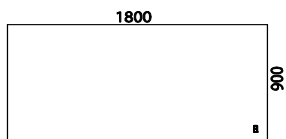
Additional cost for cable box			302	302	302	302	302
-------------------------------	--	--	-----	-----	-----	-----	-----



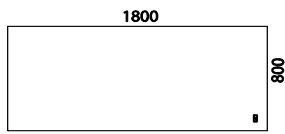
5306E



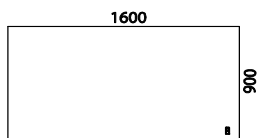
5305E



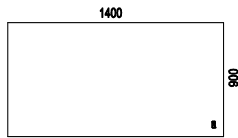
5304E



5303E



5302E



5311E

Nomono T Design: Fredrik Mattson

E Desks within size 1600x800 mm

Complete package with tabletop, frame and electrical T-legs.

Please replace the first 2 xx in the article number with the material code for the desk top.
Next 4 xxxx should be replaced with the code for the desk (the code under the desk symbol)

	Colour stand	Article number	White laminate (HPL)	Optional laminate (HPL)	Lineoleum	Veneer group 1	Veneer group 2
Tabletop incl electrical T-legs (61-126 cm)	White	53E xx xxxxx 31-E	1 662	1 915	1 726	1 821	1 821
	Black	53E xx xxxxx 37-E	1 662	1 915	1 726	1 821	1 821
Desk top only		53E xx xxxxE	320	573	384	479	479

OPTIONS:

Additional cost for cable box			302	302	302	302	302
-------------------------------	--	--	-----	-----	-----	-----	-----

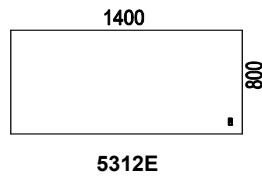
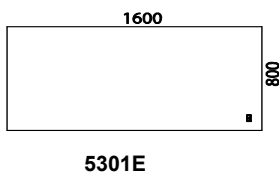
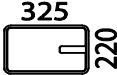
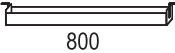
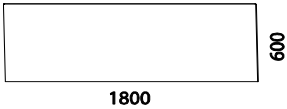
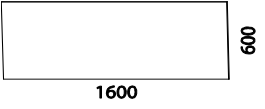
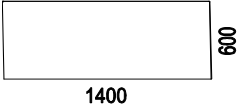


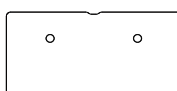
Illustration	Description	Article number	Material	EUR
Nomono T Design: Fredrik Mattson				
Nomono T ACCESSORIES The cable lid is made of the same material as the desk top, with MDF edges.				
	Extra cost for shutter on desk top.	53 31 5300xx	White HPL	302
	Incl. Plastic box (black or white) and 3-way standard socket and cable pipe in textile.	53 39 5300xx	Optional HPL	302
		53 88 5300xx	Lineleum	302
		53 xx 5300xx	Veneer gr 1	302
		53 xx 5300xx	Veneer gr 2	302
	Cable tray. Length 800 mm.	29 31 142	White	105
	Adjustable in 3 heights	29 37 142	Black	105
Nomono T FABRIC DESK SCREENS <ul style="list-style-type: none"> • For mounting in desk top • Thickness approx. 35 mm, of which 30 mm are sound absorbent • Height over desk: 500 mm • Brackets to be ordered separately. • For fabric codes: please see the supplier's website 				
Price group 1: <u>Camira:</u> Cara, Carlow <u>Gabriel:</u> Event Screen, Hush	Price group 2: <u>Camira:</u> Blazer Lite <u>Gabriel:</u> Soul, Soul Mel., Twist, Twist Mel. Focus Melange Screen, Cura Screen <u>Kvadrat:</u> Hint Screen	Price group 3: <u>Camira:</u> Blazer, Main Line Flax <u>Gabriel:</u> Step Melange Screen <u>Kvadrat:</u> Remix, Remix Screen, Floyd Screen		
	Sound absorbing desk screen, Length 1800 mm, excluding brackets	34 97 81800-x	PG 1	391
	Brackets	34 37 06794-4	PG 2	472
	Sound absorbing desk screen, Length 1600 mm, excluding brackets	34 97 81600-x	PG 3	542
	Brackets	34 37 06794-4	Black	65
	Sound absorbing desk screen, Length 1400 mm, excluding brackets	34 97 81400-x	PG 1	319
	Brackets	34 37 06794-4	PG 2	374
			PG 3	447
		34 37 06794-4	Black	65

Siglo Design: Henrik Schulz**Siglo** WORK DESKS

- Siglo tabletops in veneer, laminate and linoleum are made of 19 mm MDF with a straight pp-edge. White edge to veneer and matching edge to laminate and linoleum. Additional cost for chamfered edge.
- Siglo desk tops in white direct lam. are made of 19 mm particle board with straight edge.
- Radius 35 mm.
- Siglo has a cut-out for cables as standard. Cable holes against additional fee.

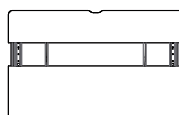
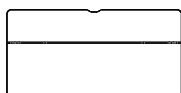


Standard



Med kabelhål (tillval)

- Electric stand, VX11, to be ordered separately. White, black and silver, range 65 cm.
- Siglo sliding tops are always delivered with chamfered edge (included in the price). Veneered tops always have a clear varnished MDF edge. Tops in laminate and linoleum have matching plastic edge. Electric stand and cable tray in felt is included.

• **Linoleum Forbo Flooring:**

4132 Ash (1B)	Closest NCS: 5502-G
4154 Burgundy (1C)	7010-R10B
4166 Charcoal (1G)	8502-B
4172 Mauve (1U)	7005-Y80R
4174 Conifer (1H)	8010-B90G
4175 Pebble (1I)	3502-Y
4176 Mushroom (1J)	2002-Y
4177 Vapour (1K)	2005-G10Y
4179 Smokey Blue (1M)	7010-R90B
4184 Olive (1R)	5010-G50Y

• **High Pressure laminate:**

White HPL (standard 0754)	Closest NCS: S0502-Y
Light grey HPL (opt. lam 0419)	S2002-Y
Light grey HPL (opt. lam 1365)	S2005-R80B
Medium grey HPL (opt. lam 1023)	S5500-N
Anthracite HPL (opt. lam 1397)	S7500-N
Black HPL (optional lam 2253)	S9000-N

• **Veneer group 1:**

Oak nature (03)
Ash nature (06)

• **Veneer group 2:**

White pigmented oak (30)
Black stained ash (86)
White pigmented ash (10)
Dark ash (76)
Burgundy ash (C8)
Conifer ash (D3)
Smokey Blue ash (D4)
Olive ash (D6)
Mushroom ash (D7)

- For additional product information please see www.horreds.se

Siglo Design: Henrik Schulz

B Desks within size 1800x900 mm.

Desk tops Siglo with cut-out for cables.

Electric stand VX11 to be ordered separately.

Replace the first 2 xx in the article number with the material code for desk top.

Next 5 xxxxx should be replaced with the code for the desk required (the code under the desk symbol)

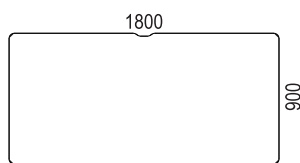
Tabletop Siglo:	Article number	White direct laminate	White laminate (HPL)	Optional lamnate (HPL)	Lino-leum	Veneer group 1	White oak (30) White ash (10) *
Siglo tabletop	60B xx 16-xxxxx	319	467	565	722	437	437
* Stained only available with chamfered edge, additional cost:							89

Electric stand:

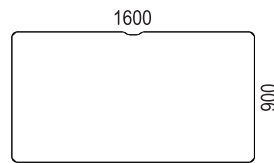
see VX11

Options:

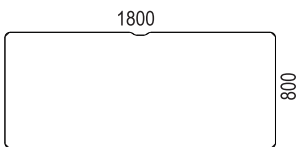
Chamfered edge Note: not in combination with direct laminate		20	89
Touchpad milled into desk top		343707444	56
Cable holes, incl. 2 lids, white/black	Plastic	60xx03118x2	155
Cable holes, incl. 2 lids	Brass	601603118x2	249
Cable holes, incl. 2 lids	Stainless	601703118x2	249



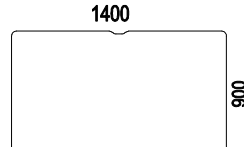
03436



03438



03435



03462

Siglo Design: Henrik Schulz

E Desks within size 1600x800 mm.

Desk tops Siglo with cut-out for cables.
Electric stand VX11 to be ordered separately.

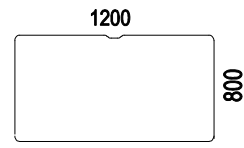
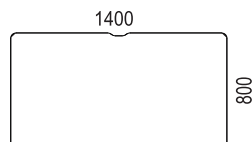
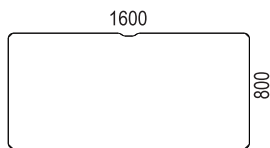
Replace the first 2 xx in the article number with the material code for desk top.
Next 5 xxxxx should be replaced with the code for the desk required (the code under the desk symbol)

Tabletop Siglo:	Article number	White direct laminate	White laminate (HPL)	Optional lamnate (HPL)	Lino-leum	Veneer group 1	White oak (30) White ash (10) *
Siglo tabletop * Stained only available with chamfered edge, additional cost:	60E xx 16-xxxxx	308	408	475	669	409	409 89

Electric stand:
see VX11

Options:

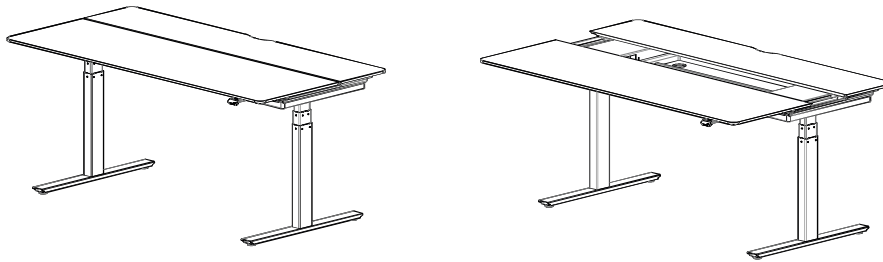
Chamfered edge Note: not in combination with direct laminate		20	89
Touchpad milled into desk top		343707444	56
Cable holes, incl. 2 lids, white/black	Plastic	60xx03118x2	155
Cable holes, incl. 2 lids	Brass	601603118x2	249
Cable holes, incl. 2 lids	Stainless	601703118x2	249



* not available with chamfered edge

Siglo Design: Henrik Schulz

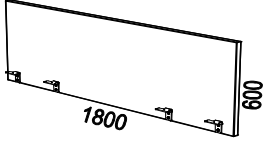
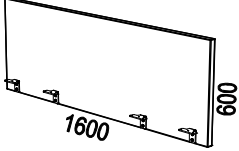
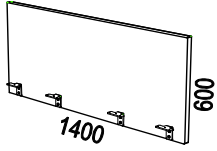
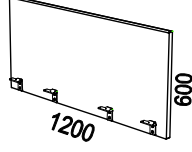
S Sliding desk



Complete package including sliding desk top with chamfered edge, frame, electrical T-legs VX8 and grey felt box.

xx in the article number should be replaced with the material code for the desk top.

		Article number	White direct laminate	White laminate (HPL)	Optional lamnate (HPL)	Lino-leum	Veneer group 1	White oak (30) White ash (10) *
1800x800:								
Sliding top 1800x800 with electrial adjustable T-legs (61-126 cm)* and grey felt box (art 6003609-2)	White	60B xx 20-03615-31S65		3 351	3 494	3 547	3 222	3 222
	Black	60B xx 20-03615-37S65		3 351	3 494	3 547	3 222	3 222
	Silver	60B xx 20-03615-38S65		3 351	3 494	3 547	3 222	3 222
1600x800:								
Sliding top 1600x800 with electrial adjustable T-legs (61-126 cm)* and grey felt box (art 6003608-2)	White	60E xx 20-03614-31S65		3 261	3 341	3 412	3 132	3 132
	Black	60E xx 20-03614-37S65		3 261	3 341	3 412	3 132	3 132
	Silver	60E xx 20-03614-38S65		3 261	3 341	3 412	3 132	3 132
1400x800:								
Sliding top 1400x800 with electrical adjustable T-legs (61-126 cm)* and grey felt box (art 6003607-2)	White	60E xx 20-03613-31S65		3 239	3 318	3 389	3 110	3 110
	Black	60E xx 20-03613-37S65		3 239	3 318	3 389	3 110	3 110
	Silver	60E xx 20-03613-38S65		3 239	3 318	3 389	3 110	3 110
Options:								
Electronic lock Mifare 13,56 Mhzfor sliding desk incl 1 user card (also includes 1 program card 371401 and 1 service card 371501 per order)		60372020		451				
Extra user card		371781		17				

Illustration	Description	Article number	EUR			
Siglo Design: Henrik Schulz						
<p>Siglo SOUND ABSORBING DESK SCREEN</p> <ul style="list-style-type: none"> • Height 600 mm (of which 500 mm over desk) • Thickness 35mm • Including black fittings • 3 different price groups • Also fits sliding desk • For additional product information; please see www.horreds.se 						
<p>Price group 1: <u>Camira:</u> Cara, Carlow <u>Gabriel:</u> Event Screen, Hush</p>		<p>Price group 2: <u>Camira:</u> Blazer Lite <u>Gabriel:</u> Soul, Soul Mel, Twist, Twist Mel, Focus Melange Screen, Cura Screen <u>Kvadrat:</u> Hint Screen</p>		<p>Price group 3: <u>Camira:</u> Blazer, Main Line Flax <u>Gabriel:</u> Step Melange Screen <u>Kvadrat:</u> Remix, Remix Screen, Floyd Scr.</p>		
	<p>Sound absorbing desk screen 1800x600 mm incl black fittings</p>	<p>60 97 81800-xxx</p>	<p>PG 1 587</p>	<p>PG 2 696</p>	<p>PG 3 798</p>	
	<p>Sound absorbing desk screen 1600x600 mm incl black fittings</p>	<p>60 97 81600-xxx</p>	<p>511</p>	<p>583</p>	<p>732</p>	
	<p>Sound absorbing desk screen 1400x600 mm incl black fittings</p>	<p>60 97 81400-xxx</p>	<p>492</p>	<p>568</p>	<p>677</p>	
	<p>Sound absorbing desk screen 1200x600 mm incl black fittings</p>	<p>60 97 81200-xxx</p>	<p>477</p>	<p>553</p>	<p>624</p>	

HORREDS WORK DESKS

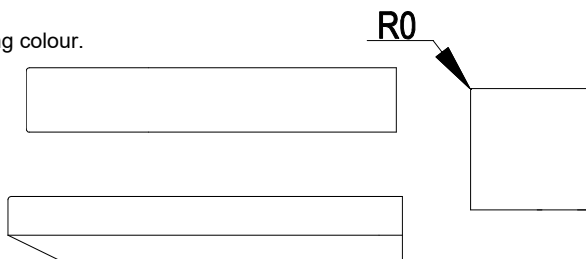


Here is a presentation of our work desks.

For information on desk materials and stands, see next page.

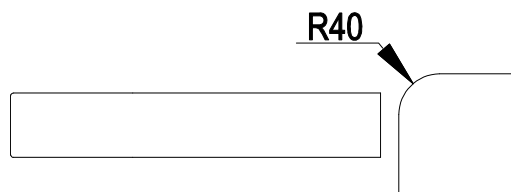
VX

- VX taböetops are made of 19 mm MDF with edging in matching colour.
- Corner radius 0 mm.
- Option: chamfered edge
- Option: cable entries
- Option: Horreds height adjustment control milled in desk top (touchpad).



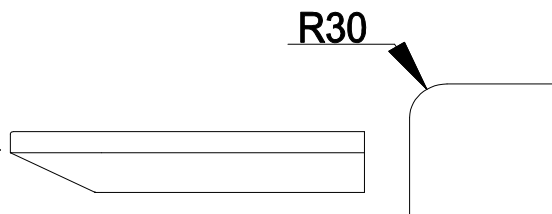
Henry Design: sandellsandberg

- Henry tabletops are made of 19 mm MDF with white plastic edge.
- Corner radius 40 mm.
- Cable holes with slot as standard unless otherwise stated in the order.
- Option: Horreds height adjustment control milled in desk top (touchpad).



Fri Design: Bror Boije

- Fri tabletops are made of 19 mm MDF with chamfered edge.
Clear coated edge on tables in ash, birch, oak, laminate and linoleum.
Matching colour on stained and white pigmented tables.
- Corner radius 30 mm.
- Option: cable entries
- Option: Horreds height adjustment control milled in desk top (touchpad).
- Horreds nedfräst handkontroll som tillval



Desk material

• High Pressure laminate:	Closest NCS:
White HPL (standard 0754)	S0502-Y
Light grey HPL (opt. lam 0419)	S2002-Y
Light grey HPL (opt. lam 1365)	S2005-R80B
Medium grey HPL (opt. lam 1023)	S5500-N
Anthracite HPL (opt. lam 1397)	S7500-N
Black HPL (optional lam 2253)	S9000-N

Linoleum:	Closest NCS:
4132 Ash	5502-G
4154 Burgundy	7010-R10B
4166 Charcoal	8502-B
4172 Mauve	7005-Y80R
4174 Conifer	8010-B90G
4175 Pebble	3502-Y
4176 Mushroom	2002-Y
4177 Vapour	2005-G10Y
4179 Smokey Blue	7010-R90B
4184 Olive	5010-G50Y

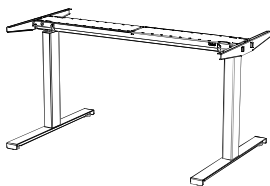
Veneer group 1:
Birch (05)
Oak (03)
Ash (06)
Veneer group 2:
White pigmented oak (30)*
White pigmented ash (10)*
Black stained ash (86)*
Dark stained ash (76)*
Burgundy ash (C8)*
Conifer ash (D3)*
Smokey Blue ash (D4)*
Olive ash (D6)*
Mushroom ash (D7)*
(*= <i>notHenry</i>)



Electric stands

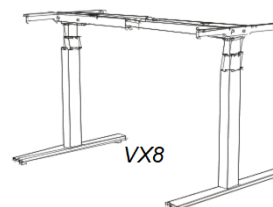
VX11:

- Range 65 cm (table height 61-126 cm).
- Lifting force 800N / leg.
- Anti-collision.
- Power consumption 0,1 w power in standeby mode.
- PVC-free system..
- Complete stand with legs, feet, black flexible frame and hand control under the table. Horreds touchpad (milled into tabletop) as option.
- Colours: White (RAL9016) / Black (RAL9005) / Silver (RAL 9006)
- Colours: White (RAL9016) / Black (RAL9005) / Silver (RAL 9006)
- Two sizes of feet; 71 and 56 cm.
- 5 years warranty..



VX8:

- Range 65 cm (table height 61-126 cm).
- Premium design with leg profiles without holes/visable glides.
- Lifting speed 80mm / s.
- Lifting force 800N / leg
- Complete stand with legs, feet, black flexible frame and hand control under the table. Horreds touchpad (milled into tabletop) as option.
- Anti-collision and soft start/stop.
- Power consumption 0,1 w power in standeby mode.
- PVC and PFAS free system
- Standard colours: Traffic white (RAL9016), Jet black (RAL9005).
- Optional colours: Grey beige (RAL1019), Ochre yellow (RAL1024), Black red (RAL3007), Grey blue (RAL5008), Fir green (RAL6009), Reed green (RAL6013), Quartz grey (RAL7039) och Silk grey (RAL7044).
- Two sizes of feet; 70 and 55 cm.
- 10 years warranty..
- Option: massive feet 70 cm black and white..



Stand with fixed height

VX10:

- Fixed height 73 cm
- Complete stand with legs, feet, black frame.
- Colours: White (RAL9016) / Black (RAL9005) / Silver (RAL 9006)
- Two sizes of feet; 70 and 55 cm.

• For additional product information please see www.horreds.se

HORREDS WORK DESKS

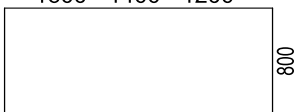
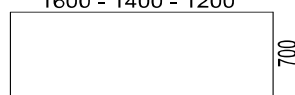
E Desks within size 1600X800 mm.

Note: Table tops and frames are priced separately.

Table top (excluding stand)	art nr	White laminate (HPL)	Optional laminate (HPL)	Linoleum	Veneer group 1	Veneer group 2
Series: Radius: Edge profile:						
VX (3416) 0 mm Straight / matching list	34xx16xxxxE	278	498	334	416	416
VX (3417) 0 mm Chamfered / matching list	34xx17xxxxE	335	555	391	473	473
Henry (80) 40 mm Straight/white pp-list, inc cable hole	80xxxxxE	320	573	384	479	
Fri (3513) 30 mm Chamfered / MDF	35xx13xxxxE	320	573	384	479	479
<i>Option: Horreds touchpad</i>	343707444	56	56	56	56	56
<i>Option: Veneered edge on laminate</i>		107	107			
<i>Option: Veneered edge on linoleum: NB: Only oak/ash nature and white pigmented (not stained!)</i>				107		

Cable holes: Henry has cable hole with slot as standard, for VX and Fri it is optional.

Stands (excl. table top)	Art nr	White (31)	Black (37)	Silver (38)	Horreds opt.colour (xx)
VX11 electric stand, range 65 cm, feet 71 cm	VX11xx657-x	549	549	549	
VX11 electric stand, range 65 cm, feet 56 cm	VX11xx655-x	549	549	549	
VX8 electric stand, range 65 cm	VX8xx2657F2	742	742		885
VX10 fixed height 73 cm	VX10xx2007F2	620	620	620	
<i>Upcharge massive feet 700 mm to VX8+VX10</i>		208	208		

	Rectangular (mm):	<i>Drawing number:</i>		
1600 - 1400 - 1200		VX	Henry	Fri
	1600x800	7025	8402	2068
	1400x800	7024	8419	2067
	1200x800	7023	8523	2066
1600 - 1400 - 1200				
	1600x700	7063	8542	2153
	1400x700	7109	8421	2245
	1200x700	7183	8594	2846

HORREDS SKRIVBORD

C Desks within size 1200X600 mm.

Note: Table tops and frames are priced separately.

Table top (excluding stand)	art nr	White laminate (HPL)	Optional laminate (HPL)	Linoleum	Veneer group 1	Veneer group 2
Series: Radius: Edge profile:						
VX (3416) 0 mm Straight / matching list	34xx16xxxxC	228	299	255	315	315
VX (3417) 0 mm Chamfered / matching list	34xx17xxxxC	285	356	312	371	371
Henry (80) 40 mm Straight/white pp-list, inc cable hole	80xxxxxC	262	344	293	362	
Fri (3513) 30 mm Chamfered / MDF	35xx13xxxxC	262	344	293	362	362
<i>Option: Horreds touchpad</i>	343707444	56	56	56	56	56
<i>Option: Veneered edge on laminate</i>		107	107			
<i>Option: Veneered edge on linoleum: NB: Only oak/ash nature and white pigmented (not stained!)</i>				107		

Cable holes: Henry has cable hole with slot as standard, for VX and Fri it is optional.

Stands (excl.table top)	Art nr	White (31)	Black (37)	Silver (38)	Horreds opt.colour (xx)
VX11 electric stand, range 65 cm	VX11xx655-x	549	549	549	
VX8 electric stand, range 65 cm	VX8xx2655F2	742	742		885
VX10 stand, fixed height 73 cm	VX10xx2005F2	620	620	620	

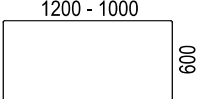
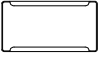
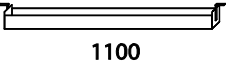
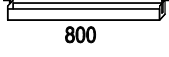
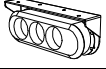

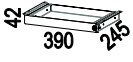
	Rectangular (mm):	Drawing number:		
		VX	Henry	Fri
	1200x600	7013	8513	2162
1000x600	7012	8567	2139	

Illustration	Description	Article nr	Colour	EUR					
CABLE ENTRIES & CABLE TRAYS FOR DESKS									
<ul style="list-style-type: none"> • Cable entries, diameter 80 mm, including lid. • For desks in series Fri and VX. • If other entry than our standard; please contact customer service for price. 									
				Entry codes					
			Colour:	Y1	Y2	Y3	Y4	Y5	Y8
	Cable entry 80 mm, including lid in plastic	3931850	white	33	33	33	39	39	39
		3937850	black	33	33	33	39	39	39
	Lid only	573180	white	7					
		573780	black	7					
	Powerdot cable entry 80 mm with 1xpower and 4 Magic Holes	935-PD10	black	Y1	Y2	Y3			
		935-PD10W	white	68	68	68			
	Powerdot cable entry 80 mm. 1 power, 2 USB-C charger (2x30W), 1 magic hole ø8 mm).	935-PD17	black	196	196	196			
		935-PD17W	white	196	196	196			
	Powerdot cable entry 60 mm 1 x power + 1 x USB-C charger 30W	935-PM62	black	F1	F2	F3			
		935-PM62W	white	149	149	149			
	Powerdot cable entry 51 mm. 1 power.	935-PM50	black	Entry codes					
		935-PM50W	white	D1	D2	D3	65	65	65
	Powerdot cable entry 51 mm. 2 USB-C charger max 30W	935-PM52	black	149	149	149			
		935-PM52W	white	149	149	149			
	Powerdot cable entry 30 mm 2 x USB-A charger 10W	935-PM30	black	J1	J2	J3			
		935-PM30W	white	91	91	91			
	Powerdot cable entry 30 mm 1 x USB-C and 1 USB-A charger 12W	935-PM32	black	144	144	144			
		935-PM32W	white	144	144	144			

Illustration	Description	Article nr	Colour	EUR		
				R1 center	R2 right	R3 left
	Cable entry including lid 233x128 in Same material as desk top Note: no matching of veneer	57xx6253K		135	135	135
	Cable entry, customized (without lid)	HAL1		118		
	Cable tray. Length 1100 mm. Adjustable 3 heights.. Minimum desk length: 1200 mm.	2937140 2931140 2938140	black white silver	105 105 105		
	Cable tray. Length 800 mm. Adjustable 3 heights.	2937142 2931142 2938142	black white silver	105 105 105		
	Power socket, 3-ways, with bracket.	343707434	black	100		
	Power socket 3-ways, 3 m cable	936-E3V30B	black	28		
	Power socket 6-ways, 3 m cable	936-E6V30B	black	33		
	Cable pipe ø 20mm in braided textile. Length 1500 mm. With zipper.	3254000109 3254000101	black white	41 41		
	Cable pipe in textile. Length 1500 mm.	29371500 29311500	black white	122 122		
	Cable cover 1300 mm i fabric (Gabriel Runner 60999) with Velcro.	341300-600	black	89		

ACCESSORIES DESKS					
• For additional product information: please see www.horreds.se					
	Metallic pen drawer 390x245x42 mm,	4048	Svart	236	
	Metallic pen drawer 390x245x42 mm, with lock.	4015-L	Svart	197	

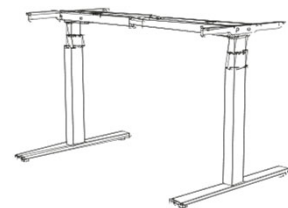
VX**VX8, VX10 & VX11 T-BENSSTATIV**

VX8 är premiumalternativet av stativ och finns i 10 kulörer.

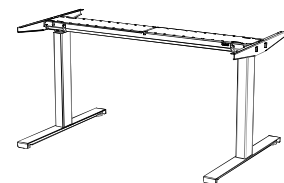
VX11 är ett stativ med enkel montering. De fyra delarna i konceptet är omsorgsfullt designade för att endera klickas samman eller fästas med några få skruvar. Sargen är hjärtat i systemet eftersom motor, elektronik och kablage redan är förmonterat i sargen.

VX8 ELECTRIC STAND

- Range 65 cm (table height 61-126 cm).
- Premium design with leg profiles without holes/visible glides.
- Transformer with programming capability. You can control your table using a programme on your computer or via an app.
- Lifting speed 80mm / s.
- Lifting force 800N / ben.
- Anti-collision and soft start/stop.
- Power consumption 0,1 w power in standeby mode.
- PVC and PFAS free system
- Complete stand with legs, feet, black flexible frame and hand control under the table. Horreds touchpad (milled into tabletop) as option.
- Standard colours: Traffic white (RAL9016), Jet black (RAL9005).
- Optional colours: Grey beige (RAL1019), Ochre yellow (RAL1024), Black red (RAL3007), Grey blue (RAL5008), Fir green (RAL6009), Reed green (RAL6013), Quartz grey (RAL7039) and Silk grey (RAL7044).
- Two sizes of feet; 70 and 55 cm.
- 10 years warranty..
- Option: massive feet 70 cm black and white..

**VX11 ELECTRIC STAND**

- Range 65 cm (table height 61-126 cm).
- Lifting force 800N / leg.
- Anti-collision.
- Power consumption 0,1 w power in standeby mode and free from PVC.
- Complete stand with legs, feet, black flexible frame and hand control under the table. Horreds touchpad (milled into tabletop) as option.
- For table tops in length 1200-1800 mm and depth 800-900 mm
- Colours: White (RAL9016) / Black (RAL9005) / Silver (RAL 9006)
- Two sizes of feet; 71 and 56 cm.
- 5 years warranty..

**VX10 FIXED HEIGHT**

- Fixed height 73 cm
- Complete stand with legs, feet, black frame.
- Colours: White (RAL9016) / Black (RAL9005) / Silver (RAL 9006)
- Two sizes of feet; 70 and 55 cm.
- For more product information see www.horreds.se

Description	Art.nr	EUR
<p>VX STANDS WITH T-LEGS</p> <p>VX11 with desk depth 800-900mm is delivered with feet 710mm, table depth 600-700mm with feet 560mm. VX8 with desk depth 800-900mm is delivered with feet 700mm, table depth 600-700mm with feet 550mm. VX10 with desk depth 800-900mm is delivered with feet 700mm, table depth 600-700mm with feet 550mm.</p> <p>Standard colours RAL VX10 / VX11: White 9016 (31), Black 9005 (37), Grey 9006 (38)</p> <p>Standard colours RAL VX8: White 9016 (31), Black 9005 (37)</p> <p>Optional colours RAL VX8: 1019 Grey beige (3H), 1024 Ochre yellow (3G), 3007 Black red (3D), 5008 Grey blue (3C) 6009 Fir green (3L), 6013 Reed green (3K), 7039 Quartz grey (3J), 7044 Silk grey (3A)</p>		

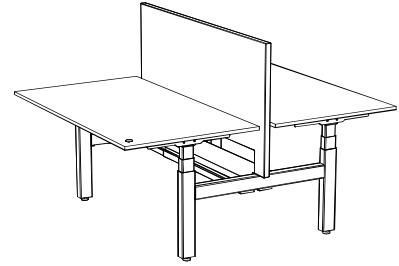
VX11	Article number	White (31) Black (37) Grey (38)
T-stand with flexible frame 1156-1756 mm, range 650mm		
VX11 to desk length 1200-1800mm and depth 800-900mm, feet 710mm	VX11xx657-x	549
VX11 till desk length 1200-1800mm and depth 600-700mm, feet 560mm	VX11xx655-x	549
	SA1023W1241	19

VX8	Article number	White (31) Black (37)	Horreds optional colours
T-stand with flexible frame (choose F1, F2, F3) feet 700mm / 550mm			
VX8, range 650mm, for desk length 1100-1600mm	VX8xx265xF1	742	885
VX8, range 650mm, for desk length 1300-1700mm	VX8xx265xF2	742	885
VX8, range 650mm, for desk length 1600-2200mm	VX8xx265xF3	742	885
Option: Massive feet 700mm (white/black)	52xx02640	208	

VX10	Article number	White (31) Black (37) Grey (38)
T-bensstativ med fast höjd, flexibel sarg (välj F1, F2, F3) fot 700mm / 550mm		
VX10, desk height 730mm, for table lengths 1100-1600mm	VX10xx200xF1	620
VX10, desk height 730mm, for table lengths 1300-1700mm	VX10xx200xF2	620
VX10, desk height 730mm, for table lengths 1600-2200mm	VX10xx200xF3	620
Option: Massive feet 700mm (white/black only)	52xx02640	208

VX DUO

D DOUBLE STAND

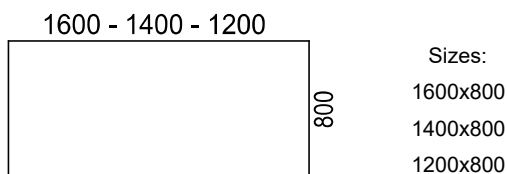
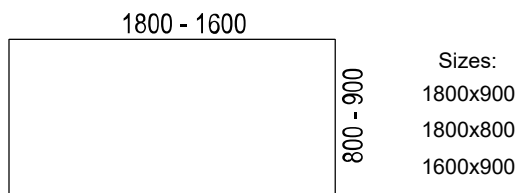


Complete package containing 2 pcs VX table top and 1 Duo stand.
Duo stand with anti-collision, lifting power 800N/leg, lifting speed 80mm/s,
PVC- and PFAS-free system, 10 years warranty

	Colour	Article number	White laminate (HPL)	Optional laminate (HPL)	Linoleum	Veneer group 1	Veneer group 2
1800x900, 1800x800, 1600x900mm: 2 x table tops and 1 x Duo stand. (60-125 cm)	White	3431DUOxxx	2 570	2 969	2 624	2 829	2 829
	Black	3437DUOxxx	2 570	2 969	2 624	2 829	2 829
1600x800, 1400x800, 1200x800mm: 2 x table tops and 1 x Duo stand. (60-125 cm)	White	3431DUOxxx	2 451	2 891	2 563	2 728	2 728
	Black	3437DUOxxx	2 451	2 891	2 563	2 728	2 728

OPTIONS:

Flexible cable tray with lid	White	34311870	184	*only clear coated and white pigmented oak/ash
Flexible cable tray with lid	Black	34371870	184	
Option: Horreds touchpad. Price per desk	Black	343707444	64	
Option: Veneered edge on laminate			107	
Option: Veneered edge on linoleum*			107	
Cable entries and accessories		See page 46		
Desk screens, table-mounted		See page52		
Desk screen mounted in the stand		See next page		



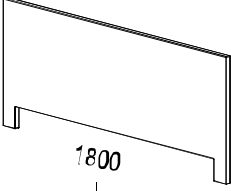
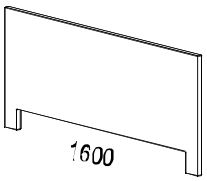
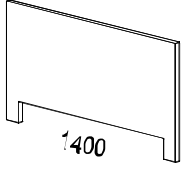
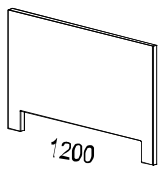
VX DUO DESK SCREENS IN FABRIC • For mounting in VX Duo stand. • Thickness approx.ca 35 mm, of which 30mm sound absorbent. • Fixed height 120 cm above floor. • Brackets are ordered separatley. Choose white or black. • Don't forget to enter the colour code; see respectively fabric supplier's website.				
Price group 1: Camira: Cara, Carlow Gabriel: Event Screen, Hush	Price group 2: Camira: Blazer Lite Gabriel: Soul, Soul Mel., Twist, Twist Mel. Focus Melange Screen, Cura Screen Kvadrat: Hint Screen	Price group 3: Camira: Blazer, Main Line Flax Gabriel: Step Melange Screen Kvadrat: Remix, Remix Screen, Floyd Screen		
	Sound absorbing desk screen Lenght 1800 mm, exklusive beslag Brackets	34 97 09440 34 xx 09441	PG 1 PG 2 PG 3 white/black	342 417 484 35
	Sound absorbing desk screen Lenght 1600 mm, exklusive beslag Brackets	34 97 09439 34 xx 09441	PG 1 PG 2 PG 3 white/black	310 372 445 35
	Sound absorbing desk screen Lenght 1400 mm, exklusive beslag Brackets	34 97 09438 34 xx 09441	PG 1 PG 2 PG 3 white/black	287 342 408 35
	Sound absorbing desk screen Lenght 1200 mm, exklusive beslag Brackets	34 97 09437 34 xx 09441	PG 1 PG 2 PG 3 white/black	272 323 374 35



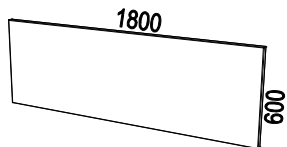
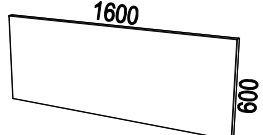
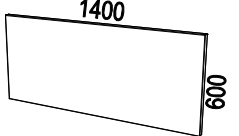
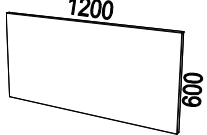
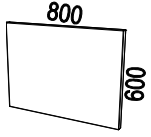
Illustration	Description	Article number	EUR		
VX					
	VX sound absorbing desk screen  <ul style="list-style-type: none"> • Height 600 mm (of which 500 mm over desk). • Fittings to be ordered separately. • Thickness 35 mm, of which 30 mm sound absorber • Specification sound absorbent: <ul style="list-style-type: none"> - 30 mm polyester wadding (1000g/m2) - 100 % polyester, up to 80% regenererade fibrer - Certified according to Ökotex, class 1. • Max weight capacity 25 kg. • Also suitable for desks Henry and Fri. • For fabric codes: please see the supplier's website • For fabric codes: please see the supplier's website 				
Price group 1: <u>Camira:</u> Cara, Carlow <u>Gabriel:</u> Event Screen, Hush		Price group 2: <u>Camira:</u> Blazer Lite <u>Gabriel:</u> Soul, Soul Mel, Twist, Twist Mel, Focus Melange Screen, Cura Screen <u>Kvadrat:</u> Hint Screen		Price group 3: <u>Camira:</u> Blazer, Main Line Flax <u>Gabriel:</u> Step Melange Screen <u>Kvadrat:</u> Remix, Remix Screen, Floyd Scr.	
			PG 1	PG 2	PG 3
	Sound absorbing desk screen, straight corners. Lenght 1800 mm, exkl brackets Brackets, 4-pcs, black	34 97 81800-x 34 37 06794-4	391 65	472 65	542 65
	Sound absorbing desk screen, straight corners. Lenght 1600 mm, exkl brackets Brackets, 4-pcs, black	34 97 81600-x 34 37 06794-4	329 65	385 65	485 65
	Sound absorbing desk screen, straight corners. Lenght 1400 mm, exkl brackets Brackets, 4-pcs, black	34 97 81400-x 34 37 06794-4	319 65	374 65	447 65
	Sound absorbing desk screen, straight corners. Lenght 1200 mm, exkl brackets Brackets, 3-pcs, black	34 97 81200-x 34 37 06794-3	308 54	364 54	412 54
	Sound absorbing desk screen, straight corners. Lenght 800 mm, exkl brackets Brackets, 2-pcs, black	34 97 08354-x 34 37 06780	206 43	244 43	276 43

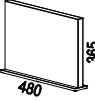
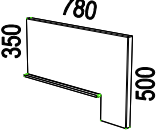

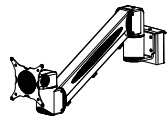

Illustration	Description	Article number	EUR		
			PG 1	PG 2	PG 3
	Sound absorbing desk screen, 480x365x35 mm. Incl foot in laquered steel. Choose colour of foot: white or black.	34 xx 03374-x	301	320	348
	Sound absorbing desk screen, 780x365x35 mm. Incl foot in laquered steel. Choose colour of foot: white or black.	34 xx 06360-x	373	410	447
Accessories to VX desk screen					
			Material	EUR	
	Accessory strip in extruded aluminum. Can be attached to the table screen or to the wall.				
	Freewall 1750 mm	670 175	Silver	181	
		670 175-1	White	181	
	Freewall 1550 mm	670 155	Silver	165	
		670 155-1	White	165	
	Freewall 1350 mm	670 135	Silver	146	
		670 135-1	White	146	
	Monitor arm D-Zine Toolbar 3 (1,5-8,5 kg) To be attached in Freewall. VESA 75 och 100.	611 325 611 325-1	Silver White	415 415	
	Pen box to free-standing desk screens	34 31 03357	White	68	
		34 37 03357	Black	68	


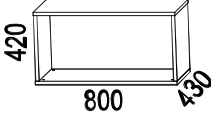
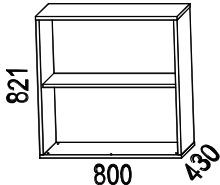
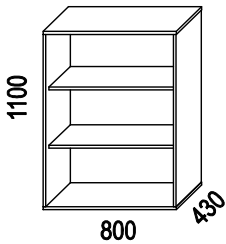
Illustration	Description	Article number	Material	EUR
<p style="text-align: center;">STORAGE BASIC UNITS</p> <div style="text-align: right;">  </div> <ul style="list-style-type: none"> • Basic unit in direct laminated or veneered particle board • White direct laminate = closest NCS S0300-N • Stationary shelves • For additional product information; please see www.horreds.se <p><u>Veneer group 1:</u> Birch (05), Oak (03), Ash (06).</p> <p><u>Veneer group 2:</u> White pigmented Oak (30), White pigmented Ash (10), Black stained Ash (86), Dark stained Ash (76).</p> <p>Note! Price is for basic unit only</p> <ul style="list-style-type: none"> • Base to be ordered separately. • Sliding doors to be ordered separately. 				
WIDTH 800 MM:				
	<p>Basic unit 800x420x430 mm. 1xA4-height prepared for sliding doors.</p> <p>As above but not prepared for sliding doors</p>	<p>57 31 71310 57 xx 71310 57 xx 71310</p> <p>57 31 71300 57 xx 71300 57 xx 71300</p>	<p>White direct lam. Veneer group 1 Veneer group 2</p> <p>White direct lam. Veneer group 1 Veneer group 2</p>	<p>440 682 682</p> <p>440 682 682</p>
	<p>Basic unit 800x821x430 mm. 2xA4-height prepared for sliding doors.</p> <p>As above but not prepared for sliding doors</p>	<p>57 31 72310 57 xx 72310 57 xx 72310</p> <p>57 31 72300 57 xx 72300 57 xx 72300</p>	<p>White direct lam. Veneer group 1 Veneer group 2</p> <p>White direct lam. Veneer group 1 Veneer group 2</p>	<p>482 889 889</p> <p>482 889 889</p>
	<p>Basic unit 800x1100x430 mm. 3xA4-height prepared for sliding doors.</p> <p>As above but not prepared for sliding doors</p>	<p>57 31 73310 57 xx 73310 57 xx 73310</p> <p>57 31 73300 57 xx 73300 57 xx 73300</p>	<p>White direct lam. Veneer group 1 Veneer group 2</p> <p>White direct lam. Veneer group 1 Veneer group 2</p>	<p>613 1 216 1 216</p> <p>613 1 216 1 216</p>

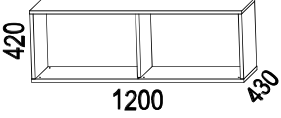
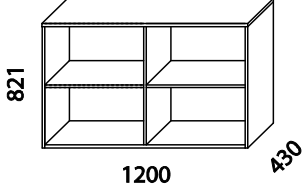
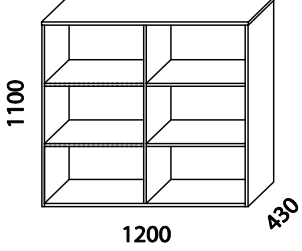
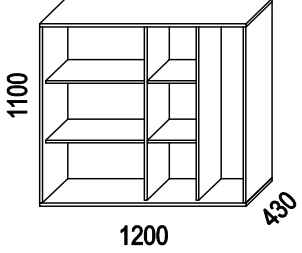
Illustration	Description	Article number	Material	EUR
WIDTH 1200 MM:				
	Basic unit 1200x420x430 mm. 1xA4-height prepared for sliding doors.	57 31 71510	White direct lam.	498
		57 xx 71510	Veneer group 1	904
		57 xx 71510	Veneer group 2	904
	As above but not prepared for sliding doors	57 31 71500	White direct lam.	498
		57 xx 71500	Veneer group 1	904
		57 xx 71500	Veneer group 2	904
	Basic unit 1200x821x430 mm. 2xA4-height prepared for sliding doors.	57 31 72510	White direct lam.	580
		57 xx 72510	Veneer group 1	1 194
		57 xx 72510	Veneer group 2	1 194
	As above but not prepared for sliding doors	57 31 72500	White direct lam.	580
		57 xx 72500	Veneer group 1	1 194
		57 xx 72500	Veneer group 2	1 194
	Basic unit 1200x1100x430 mm. 3xA4-height prepared for sliding doors.	57 31 73510	White direct lam.	662
		57 xx 73510	Veneer group 1	1 260
		57 xx 73510	Veneer group 2	1 260
	As above but not prepared for sliding doors	57 31 73500	White direct lam.	662
		57 xx 73500	Veneer group 1	1 260
		57 xx 73500	Veneer group 2	1 260
	Basic unit 1200x1100x430 mm with wardrobe compartment. 3xA4-height, prepared for sliding doors.	57 31 73512	White direct lam.	892
		57 xx 73512	Veneer group 1	1 576
		57 xx 73512	Veneer group 2	1 576

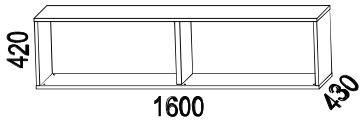
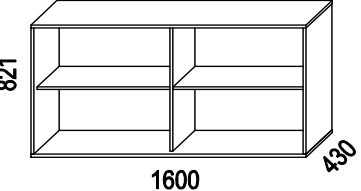
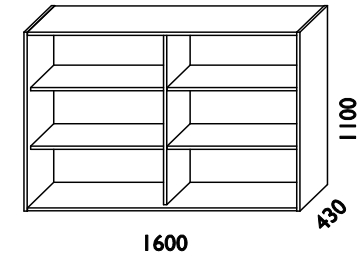
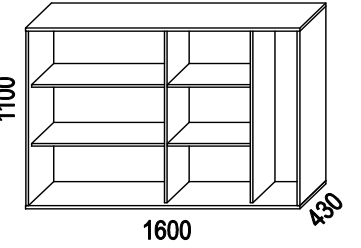
Illustration	Description	Article number	Material	EUR
WIDTH 1600 MM:				
	Basic unit 1600x420x430 mm. 1xA4-height, prepared for sliding doors.	57 31 71710	White direct lam.	635
		57 xx 71710	Veneer group 1	1 066
		57 xx 71710	Veneer group 2	1 066
	As above but not prepared for sliding doors	57 31 71700	White direct lam.	635
		57 xx 71700	Veneer group 1	1 066
		57 xx 71700	Veneer group 2	1 066
	Basic unit 1600x821x430 mm. 2xA4-height, prepared for sliding doors.	57 31 72710	White direct lam.	706
		57 xx 72710	Veneer group 1	1 437
		57 xx 72710	Veneer group 2	1 437
	As above but not prepared for sliding doors	57 31 72700	White direct lam.	706
		57 xx 72700	Veneer group 1	1 437
		57 xx 72700	Veneer group 2	1 437
	Basic unit 1600x1100x430 mm. 3xA4-height, prepared for sliding doors.	57 31 73710	White direct lam.	884
		57 xx 73710	Veneer group 1	1 556
		57 xx 73710	Veneer group 2	1 556
	As above but not prepared for sliding doors	57 31 73700	White direct lam.	884
		57 xx 73700	Veneer group 1	1 556
		57 xx 73700	Veneer group 2	1 556
	Basic unit 1600x1100x430 mm with wardrobe compartment. 3xA4-height, prepared for sliding doors.	57 31 73712	White direct lam.	1 046
		57 xx 73712	Veneer group 1	1 922
		57 xx 73712	Veneer group 2	1 922


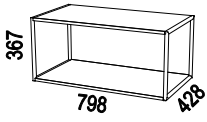
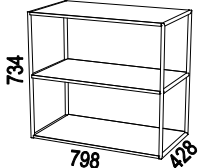
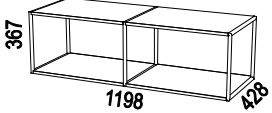
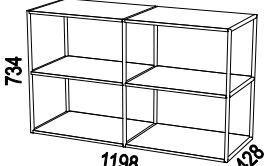
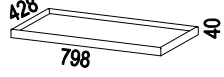
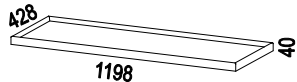
Illustration	Description	Article number	Material	EUR
Biblio Design: Anderssen & Voll				
 MÖBELFAKTA				
BIBLIO EXTENSION UNITS <ul style="list-style-type: none"> • Metallic extension unit I: white (RAL 9016 str) and black (RAL 9005 str) • Shelves: <ul style="list-style-type: none"> -White lacquer NCS S0300-N -Veneer group 1: Oak (03), Ash (06) - Veneer group 2: Black ash (86), Dark ash (76), White oak (30), White ash (10) • For additional product information see www.horreds.se 				
	Extension unit 798x367x428 mm	64 xx31 -0801	White shelves	549
	in white or black metal with shelves	64 xxxx -0801	Veneer gr 1 shelves	689
	in white lacquer or veneer	64 xxxx -0801	Veneer gr 2 shelves	689
	Extension unit 798x734x428 mm	64 xx31 -0802	White shelves	671
	in white or black metal with shelves	64 xxxx -0802	Veneer gr 1 shelves	892
	in white lacquer or veneer	64 xxxx -0802	Veneer gr 2 shelves	892
	Extension unit 1198x367x428 mm	64 xx31 -1201	White shelves	786
	in white or black metal with shelves	64 xxxx -1201	Veneer gr 1 shelves	1 059
	in white lacquer or veneer	64 xxxx -1201	Veneer gr 2 shelves	1 059
	Extension unit 1198x734x428 mm	64 xx31 -1202	White shelves	1 126
	in white or black metal with shelves	64 xxxx -1202	Veneer gr 1 shelves	1 503
	in white lacquer or veneer	64 xxxx -1202	Veneer gr 2 shelves	1 503
BIBLIO TRAYS <ul style="list-style-type: none"> • Tray in veneer with massive edges. -Veneer group 1: Oak (03), Ash (06) - Veneer group 2: Black ash (86), Dark ash (76), White oak (30), White ash (10) • For additional product information see www.horreds.se 				
	Tray 798x428x40 mm	64 xx 07525-080	Veneer group 1	489
			Veneer group 2	489
	Tray 1198x428x40 mm	64 xx 07525-120	Veneer group 1	515
			Veneer group 2	515


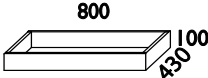
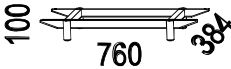
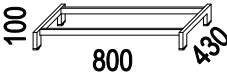
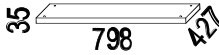

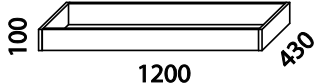
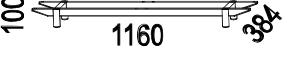
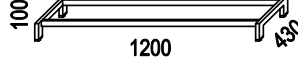
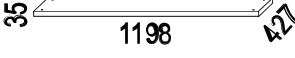

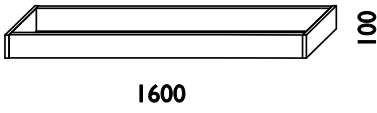
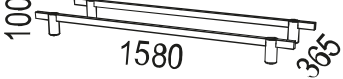
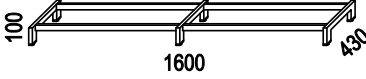
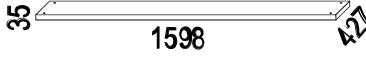



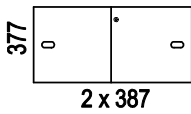
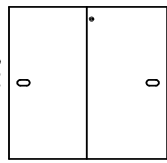
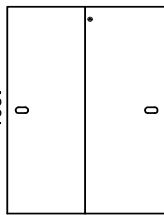
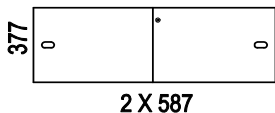
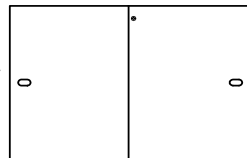
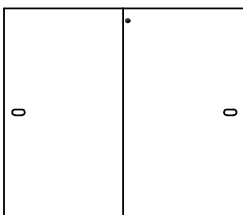

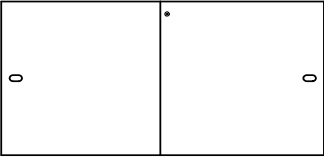
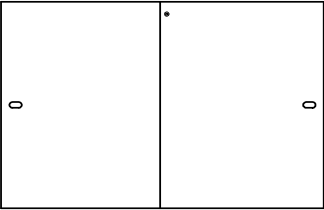
Illustration	Description	Article number	Material	EUR
<p>BASES</p> <p>• For basic units with depth 430 mm. • For additional product information; please see www.horreds.se</p> <p><u>Veneer group 1:</u> Birch (05) Oak (03) Ash (06)</p> <p><u>Veneer group 2:</u> White pigmented Oak (30) White pigmented Ash (10) Black stained Ash (86) Dark stained Ash (76)</p> 				
WIDTH 800 MM:				
	Base 800x100x430 mm	57 31 70310 57 xx 70310 57 xx 70310	Vit direktlam. Faner grupp 1 Faner grupp 2	122 141 141
	Leg base, solid wood, height 100 mm.	57 03 70340 57 06 70340 57 xx 70340	Ek Ask Faner grupp 2	324 324 324
	Leg base 800x100x430 mm, steel med ställfötter	57 31 70330 57 37 70330	Vit Svart	148 148
	Base plate with small adjustable feet, 798x35x427 mm	57 31 70381 57 xx 70381 57 xx 70381	Vit direktlam. Faner grupp 1 Faner grupp 2	65 99 99
	Castors. Height 100 mm. For 800 mm wide storage (4 castors of which 2 lockable)	39 08 28	Grå/Zink	68
	Adjustable furniture feet (4 pieces)	57 00 04-19		24

Illustration	Description	Article number	Material	EUR
WIDTH 1200 MM:				
	Base 1200x100x430 mm	57 31 70510 57 xx 70510 57 xx 70510	White dir.lam. Veneer group 1 Veneer group 2	134 174 174
	Leg base, solid wood, height 100 mm.	57 03 70540 57 06 70540 57 xx 70540	Oak Ash Veneer group 2	388 388 388
	Leg base 1200x100x430 mm, steel	57 31 70530 57 37 70530	White Blacke	166 166
	Base plate with small adjustable feet, 1198x35x427 mm	57 31 70581 57 xx 70581 57 xx 70581	Grey/zink	95 112 112
	Castors. Height 100 mm. to 1200 mm wide storage (5 castors of which 2 lockable)	39 08 28-1	White dir.lam. Veneer group 1 Veneer group 2	87
	Adjustable furniture feet (6 pieces)	57 00 06-19		29
WIDTH 1600 MM:				
	Base 1600x100x430 mm	57 31 70710 57 xx 70710 57 xx 70710	White dir.lam. Veneer group 1 Veneer group 2	140 217 217
	Leg base, solid wood, height 100 mm.	57 03 70740 57 06 70740 57 xx 70740	Oak Ash Veneer group 2	497 497 497
	Leg base 1600x100x430 mm, steel	57 31 70730 57 37 70730	White Black	193 193
	Base plate with small adjustable feet, 1598x35x427 mm	57 31 70781 57 xx 70781 57 xx 70781	Grey/zink	102 124 124
	Castors. Height 100 mm. to 1600 mm wide storage (6 castors of which 3 lockable)	39 08 28-2	White dir.lam. Veneer group 1 Veneer group 2	106
	Adjustable furniture feet (6 pieces)	57 00 06-19		29

Description	Article number	Material	EUR
Biblio Design: Anderssen & Voll			
<p style="text-align: center;">Biblio SLIDING DOORS</p> <div style="display: flex; justify-content: space-between; align-items: center;"> <ul style="list-style-type: none"> • Sliding doors in lacquered or veneered MDF • Handles in veneered steel • Fronts in optional NCS: delivery time 6 weeks. • Including lock with 2 keys • For additional product information please see www.horreds.se  </div> <p><u>Note! Price is for sliding doors only.</u></p> <ul style="list-style-type: none"> • Basic unit and base to be ordered separately. <div style="display: flex; justify-content: space-between; margin-top: 20px;"> <div style="width: 45%;"> <p><u>Material:</u></p> <p>Veneer group 1:</p> <p>Oak (03)</p> <p>Ash (06)</p> <p>Veneer group 2:</p> <p>White pigmented Oak (30)</p> <p>White pigmented Ash (10)</p> <p>Black stained Ash (86)</p> <p>Dark stained Ash (76)</p> <p>White laquer:</p> <p>NCS S0300-N (31)</p> </div> <div style="width: 45%;"> <p><u>Handles:</u></p> <p>03 Oak</p> <p>06 Ash</p> <p>30 White pigmented oak</p> <p>10 White pigmented ash</p> <p>86 Black stained ash</p> <p>76 Dark stained ash</p> <p>31 White (RAL 9016)</p> </div> </div>			
			

Description	Article number	Material	EUR		
FOR STORAGE WIDTH 800 MM:					
 <p>377 0 0 2 x 387</p>	Biblio sliding doors 1xA4-height. Fit on basic unit 800x420x430 mm (art 71310)	64 31xx 713481A White direct laminate 64 xxxx 713481A Veneer group 1 64 xxxx 713481A Veneer group 2 64 99xx 713481A Optional NCS	554 653 653 797		
	 <p>778 0 0 2 x 387</p>	Biblio sliding doors 2xA4-height. Fit on basic unit 1200x821x430 mm (art 72510)	64 31xx 723481A White direct laminate 64 xxxx 723481A Veneer group 1 64 xxxx 723481A Veneer group 2 64 99xx 723481A Optional NCS	574 673 673 816	
		 <p>1057 0 0 2 x 387</p>	Biblio sliding doors 3xA4-height. Fit on basic unit 800x1100x430 mm (art 73310)	64 31xx 733481A White direct laminate 64 xxxx 733481A Veneer group 1 64 xxxx 733481A Veneer group 2 64 99xx 733481A Optional NCS	593 692 692 836
			FOR STORAGE WIDTH 1200 MM:		
 <p>377 0 0 2 X 587</p>			Biblio sliding doors 1xA4-height. Fit on basic unit 1200x420x430 mm (art 71510)	64 31xx 715481A White direct laminate 64 xxxx 715481A Veneer group 1 64 xxxx 715481A Veneer group 2 64 99xx 715481A Optional NCS	561 659 659 803
	 <p>778 0 0 2 X 587</p>		Biblio sliding doors 2xA4-height. fit on basic unit 1200x821x430 mm (art 72510)	64 31xx 725481A White direct laminate 64 xxxx 725481A Veneer group 1 64 xxxx 725481A Veneer group 2 64 99xx 725481A Optional NCS	601 699 699 843
		 <p>1057 0 0 2 X 587</p>	Biblio sliding doors 3xA4-height. Fit on basic unit 1200x1100x430 mm (art 73510 och 73512)	64 31xx 735481A White direct laminate 64 xxxx 735481A Veneer group 1 64 xxxx 735481A Veneer group 2 64 99xx 735481A Optional NCS	627 725 725 869

Description	Article number	Material	EUR
FOR STORAGE WIDTH 1600 MM:			
377  2 X 791	Biblio sliding doors 1xA4-height. Fit on basic unit 1600x420x430 mm (art 71710)	64 31xx 717481A White direct laminate 64 xxxx 717481A Veneer group 1 64 xxxx 717481A Veneer group 2 64 99xx 717481A Optional NCS	593 692 692 836
778  2 X 791	Biblio sliding doors 2xA4-height. Fit on basic unit 1600x821x430 mm (art 72710)	64 31xx 727481A White direct laminate 64 xxxx 727481A Veneer group 1 64 xxxx 727481A Veneer group 2 64 99xx 727481A Optional NCS	640 814 814 883
1057  2 X 791	Biblio sliding doors 3xA4-height. Fit on basic unit 1600x1100x430 mm (art 73710 och 73712)	64 31xx 737481A White direct laminate 64 xxxx 737481A Veneer group 1 64 xxxx 737481A Veneer group 2 64 99xx 737481A Optional NCS	689 851 851 932

Description	Article number	Material	EUR
-------------	----------------	----------	-----

Nomono Design: Fredrik Mattson

Nomono SLIDING DOORS



- Sliding doors in lacquered or veneered MDF
- Handles in lacquered steel sheet
- Fronts in optional NCS: delivery time 6 weeks.
- Including lock with 2 keys
- For additional product information please see www.horreds.se

Note! Price is for sliding doors only.

- Basic unit and base to be ordered separately.

Material:

Veneer group 1:

Birch (05)

Oak (03)

Ash (06)

Veneer group 2:

White pigmented Oak (30)

White pigmented Ash (10)

Black stained Ash (86)

Dark stained Ash (76)

White laquer:

NCS S0300-N (31)

Colour handles / Closest NCS

31 White S0300-N

37 Black S9000-N

32 Yellow S1070-Y

36 Green S2570-G30Y

33 Red S1580-Y80R

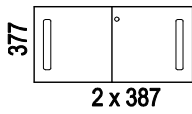
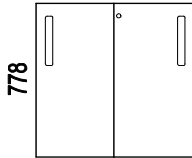
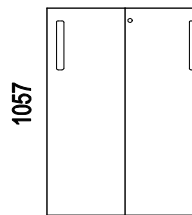
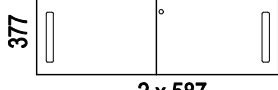
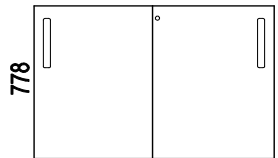
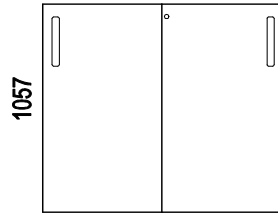
35 Turq.Blue S540-B30G

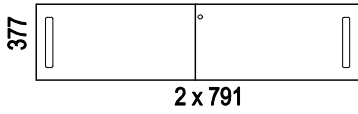
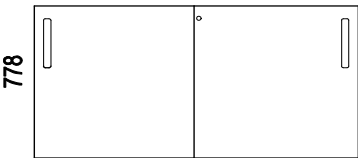
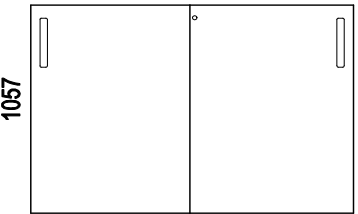
42 Orange S1080-Y50R

xx *Elmosoft Light Brown 54035

* additional cost € 72



Description	Article number	Material	EUR
FOR STORAGE WIDTH 800 MM:			
 <p>377 2 x 387</p>	Nomono sliding doors 1xA4-height. Fit on basic unit 800x420x430 mm (art 71310)	53 31xx 713381A White laquer	524
		53 xxxx 713381A Veneer group 1	621
		53 xxxx 713381A Veneer group 2	621
		53 99xx 713381A Optional NCS	762
 <p>778 2 x 387</p>	Nomono sliding doors 2xA4-height. Fit on basic unit 800x821x430 mm (art 72510)	53 31xx 723381A White laquer	544
		53 xxxx 723381A Veneer group 1	641
		53 xxxx 723381A Veneer group 2	641
		53 99xx 723381A Optional NCS	781
 <p>1057 2 x 387</p>	Nomono sliding doors 3xA4-height. Fit on basic unit 800x1100x430 mm (art 73310)	53 31xx 733381A White laquer	563
		53 xxxx 733381A Veneer group 1	660
		53 xxxx 733381A Veneer group 2	660
		53 99xx 733381A Optional NCS	801
FOR STORAGE WIDTH 1200 MM:			
 <p>377 2 x 587</p>	Nomono sliding doors 1xA4-height. Fit on basic unit 1200x420x430 mm (art 71510)	53 31xx 715381A White laquer	531
		53 xxxx 715381A Veneer group 1	627
		53 xxxx 715381A Veneer group 2	627
		53 99xx 715381A Optional NCS	768
 <p>778 2 x 587</p>	Nomono sliding doors 2xA4-height. fit on basic unit 1200x821x430 mm (art 72510)	53 31xx 725381A White laquer	569
		53 xxxx 725381A Veneer group 1	666
		53 xxxx 725381A Veneer group 2	666
		53 99xx 725381A Optional NCS	808
 <p>1057 2 x 587</p>	Nomono sliding doors 3xA4-height. Fit on basic unit 1200x1100x430 mm (art 73510 och 73512)	53 31xx 735381A White laquer	595
		53 xxxx 735381A Veneer group 1	692
		53 xxxx 735381A Veneer group 2	692
		53 99xx 735381A Optional NCS	833

Description	Article number	Material	EUR
FOR STORAGE WIDTH 1600 MM:			
 <p>377 2 x 791</p>	<p>Nomono sliding doors 1xA4-height. Fit on basic unit 1600x420x430 mm (art 71710)</p>	<p>53 31xx 717381A 53 xxxx 717381A 53 xxxx 717381A 53 99xx 717381A</p>	<p>White laquer 563 Veneer group 1 660 Veneer group 2 660 Optional NCS 801</p>
 <p>778 2 x 791</p>	<p>Nomono sliding doors 2xA4-height. Fit on basic unit 1600x821x430 mm (art 72710)</p>	<p>53 31xx 727381A 53 xxxx 727381A 53 xxxx 727381A 53 99xx 727381A</p>	<p>White laquer 608 Veneer group 1 779 Veneer group 2 779 Optional NCS 846</p>
 <p>1057 2 x 791</p>	<p>Nomono sliding doors 3xA4-height. Fit on basic unit 1600x1100x430 mm (art 73710 och 73712)</p>	<p>53 31xx 737381A 53 xxxx 737381A 53 xxxx 737381A 53 99xx 737381A</p>	<p>White laquer 657 Veneer group 1 815 Veneer group 2 815 Optional NCS 895</p>

Description	Article number	Material	EUR
-------------	----------------	----------	-----

VX



VX SLIDING DOORS

- Sliding doors in white direct laminated particle board or veneered MDF
- Steel handle
- Fronts in optional NCS (lacquered MDF): delivery time 6 weeks
- Including lock with 2 keys
- For additional product information please see www.horreds.se

Note! Price is for sliding doors only.

- Basic unit and base be ordered separately.

Material:

Veneer group 1:

Birch (05)

Oak (03)

Ash (06)

Veneer group 2:

White pigmented Oak (30)

White pigmented Ash (10)

Black stained Ash (86)

Dark stained Ash (76)

White direct laminate:

NCS S0300-N (31)

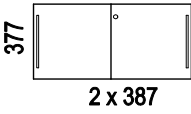
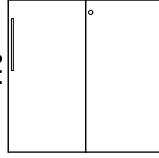
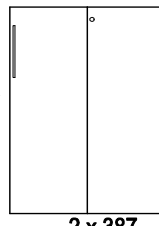
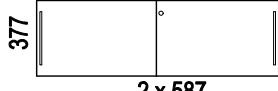
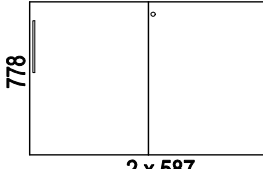
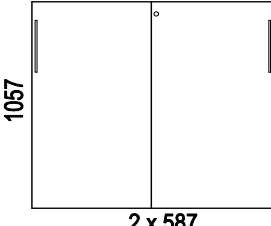
Colour handles

31 White

37 Black

17 Stainless steel look



Description	Article number	Material	EUR	
FOR STORAGE WIDTH 800 MM:				
 <p>377 2 x 387</p>	VX sliding doors 1xA4-height. Fit on basic unit 800x420x430 mm (art 71310)	34 31xx 713481A	White direct laminate	282
		34 xxxx 713481A	Veneer group 1	497
		34 xxxx 713481A	Veneer group 2	497
		34 99xx 713481A	Optional NCS	520
 <p>778 2 x 387</p>	VX sliding doors 2xA4-height. Fit on basic unit 800x821x430 mm (art 72510)	34 31xx 723481A	White direct laminate	298
		34 xxxx 723481A	Veneer group 1	515
		34 xxxx 723481A	Veneer group 2	515
		34 99xx 723481A	Optional NCS	536
 <p>1057 2 x 387</p>	VX sliding doors 3xA4-height. Fit on basic unit 800x1100x430 mm (art 73310)	34 31xx 733481A	White direct laminate	311
		34 xxxx 733481A	Veneer group 1	534
		34 xxxx 733481A	Veneer group 2	534
		34 99xx 733481A	Optional NCS	549
FOR STORAGE WIDTH 1200 MM:				
 <p>377 2 x 587</p>	VX sliding doors 1xA4-height. Fit on basic unit 1200x420x430 mm (art 71510)	34 31xx 715481A	White direct laminate	289
		34 xxxx 715481A	Veneer group 1	503
		34 xxxx 715481A	Veneer group 2	503
		34 99xx 715481A	Optional NCS	527
 <p>778 2 x 587</p>	VX sliding doors 2xA4-height. fit on basic unit 1200x821x430 mm (art 72510)	34 31xx 725481A	White direct laminate	314
		34 xxxx 725481A	Veneer group 1	540
		34 xxxx 725481A	Veneer group 2	540
		34 99xx 725481A	Optional NCS	551
 <p>1057 2 x 587</p>	VX sliding doors 3xA4-height. Fit on basic unit 1200x1100x430 mm (art 73510 och 73512)	34 31xx 735481A	White direct laminate	332
		34 xxxx 735481A	Veneer group 1	565
		34 xxxx 735481A	Veneer group 2	565
		34 99xx 735481A	Optional NCS	570

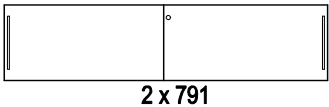
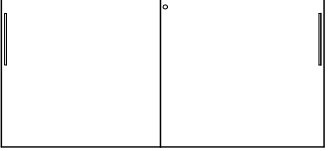
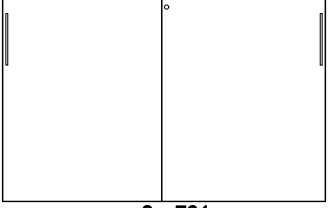
Description	Article number	Material	EUR
FOR STORAGE WIDTH 1600 MM::			
 <p>377 2 x 791</p>	<p>VX sliding doors 1xA4-height. Fit on basic unit 1600x420x430 mm (art 71710)</p>	<p>34 31xx 717481A 34 717481A 34 717481A 34 717481A</p>	<p>White direct laminate 304 Veneer group 1 534 Veneer group 2 534 Optional NCS 543</p>
 <p>778 2 x 791</p>	<p>VX sliding doors 2xA4-height. Fit on basic unit 1600x821x430 mm (art 72710)</p>	<p>34 31xx 727481A 34 xxxx 727481A 34 xxxx 727481A 34 99xx 727481A</p>	<p>White direct laminate 332 Veneer group 1 649 Veneer group 2 649 Optional NCS 570</p>
 <p>1057 2 x 791</p>	<p>VX sliding doors 3xA4-height. Fit on basic unit 1600x1100x430 mm (art 73710 och 73712)</p>	<p>34 31xx 737481A 34 xxxx 737481A 34 xxxx 737481A 34 99xx 737481A</p>	<p>White direct laminate 370 Veneer group 1 683 Veneer group 2 683 Optional NCS 608</p>



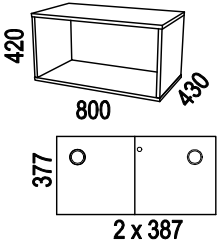
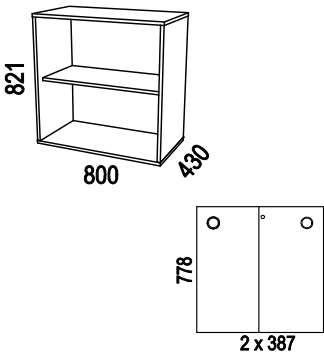
Illustration	Description	Article number	Material	EUR
Siglo Design: Henrik Schulz				
	<p>Siglo STORAGE</p> <ul style="list-style-type: none"> • Basic unit in direct laminated alt. veneered particle board • Doors in direct laminate alt. veneered MDF • Back in melamine • Works also as a room divider • Stationary shelves • Adjustable furniture feet as standard. Wooden base as option • For additional product information; please see www.horreds.se <p><u>Material:</u></p> <p>Veneer group 1: Birch (05) Oak (03) Ash (06)</p> <p>Veneer group 2: Black stained Ash (86) Dark stained Ash (76) White pigmented Oak (30) White pigmented Ash (10)</p> <p>White direct laminate: Closest NCS: S0300-N</p> <p><u>Handles standard:</u></p> <p>31 White plastic 37 Black plastic</p> <p><u>Handles optional:</u></p> <p>16 Brass 17 Stainless</p> <p><u>Options:</u></p> <ul style="list-style-type: none"> • Handles in brass or stainless steel: additional fee € 278. • Doors in optional NCS: additional fee € 256. Delivery time 6 weeks. 		<p>MÖBELFAKTA</p>	
WIDTH 800 MM:			Unit / doors	
	<p>Unit 800x420x430 mm (art 71310) including sliding doors (art 713081A) and adjustable feet (art 600004-19).</p>	<p>60 3131xx S1A1</p> <p>60 31xxxx S1A1</p> <p>60 31xxxx S1A1</p> <p>60 xx31xx S1A1</p> <p>60 xx31xx S1A1</p> <p>60 xxxxxx S1A1</p> <p>60 xxxxxx S1A1</p>	<p>White/white</p> <p>White/veneer gr 1</p> <p>White/veneer gr 2</p> <p>Veneer gr 1 / White</p> <p>Veneer gr 2 / White</p> <p>Veneer/veneer gr 1</p> <p>Veneer/veneer gr 2</p>	<p>808</p> <p>1 049</p> <p>1 049</p> <p>1 078</p> <p>1 078</p> <p>1 336</p> <p>1 336</p>
	<p>Unit 800x821x430 mm (art 72310) including sliding doors (art 723081A) and adjustable feet (art 600004-19).</p>	<p>60 3131xx S1A2</p> <p>60 31xxxx S1A2</p> <p>60 31xxxx S1A2</p> <p>60 xx31xx S1A2</p> <p>60 xx31xx S1A2</p> <p>60 xxxxxx S1A2</p> <p>60 xxxxxx S1A2</p>	<p>White/white</p> <p>White/veneer gr 1</p> <p>White/veneer gr 2</p> <p>Veneer gr 1 / White</p> <p>Veneer gr 2 / White</p> <p>Veneer/veneer gr 1</p> <p>Veneer/veneer gr 2</p>	<p>940</p> <p>1 184</p> <p>1 184</p> <p>1 314</p> <p>1 314</p> <p>1 575</p> <p>1 575</p>

Illustration	Description	Article number	Material	EUR
	Unit 800x1100x430 mm (art 73310) including sliding doors (art 733081A) and adjustable feet (art 600004-19).	60 3131xx S1A3	White/white	1 039
		60 31xxxx S1A3	White/veneer gr 1	1 290
		60 31xxxx S1A3	White/veneer gr 2	1 290
		60 xx31xx S1A3	Veneer gr 1 / White	1 672
		60 xx31xx S1A3	Veneer gr 2 / White	1 672
		60 xxxxxx S1A3	Veneer/veneer gr 1	1 942
		60 xxxxxx S1A3	Veneer/veneer gr 2	1 942
	<i>Add. fee for base 800x100x430 mm instead of adjustable furniture feet</i>	60 31 70310	White direct lam.	120
		60 xx 70310	Veneer group 1	133
		60 xx 70310	Veneer group 2	133
WIDTH 1200 MM:				
	Unit 1200x420x430 mm (art 71510) including sliding doors (art 715081A) and adjustable feet (art 600004-19).	60 3131xx S1B1	White/white	918
		60 31xxxx S1B1	White/veneer gr 1	1 158
		60 31xxxx S1B1	White/veneer gr 2	1 158
		60 xx31xx S1B1	Veneer gr 1 / White	1 318
		60 xx31xx S1B1	Veneer gr 2 / White	1 318
		60 xxxxxx S1B1	Veneer/veneer gr 1	1 577
		60 xxxxxx S1B1	Veneer/veneer gr 2	1 577
	Unit 1200x821x430 mm (art 72510) including sliding doors (art 725081A) and adjustable feet (art 600004-19).	60 3131xx S1B2	White/white	1 123
		60 31xxxx S1B2	White/veneer gr 1	1 377
		60 31xxxx S1B2	White/veneer gr 2	1 377
		60 xx31xx S1B2	Veneer gr 1 / White	1 653
		60 xx31xx S1B2	Veneer gr 2 / White	1 653
		60 xxxxxx S1B2	Veneer/veneer gr 1	1 926
		60 xxxxxx S1B2	Veneer/veneer gr 2	1 926
	Unit 1200x1100x430 mm (art 73510) including sliding doors (art 735081A) and adjustable feet (art 600004-19).	60 3131xx S1B3	White/white	1 144
		60 31xxxx S1B3	White/veneer gr 1	1 412
		60 31xxxx S1B3	White/veneer gr 2	1 412
		60 xx31xx S1B3	Veneer gr 1 / White	1 738
		60 xx31xx S1B3	Veneer gr 2 / White	1 738
		60 xxxxxx S1B3	Veneer/veneer gr 1	2 026
		60 xxxxxx S1B3	Veneer/veneer gr 2	2 026

Illustration	Description	Article number	Material	EUR
	Unit 1200x1100x430 mm with wardrobe (art 73512) including sliding doors (art 735081A) and clamping knobs (art 600006-19).	60 3131xx S1BG	White/white	1 555
		60 31xxxx S1BG	White/veneer gr 1	1 824
		60 31xxxx S1BG	White/veneer gr 2	1 824
		60 xx31xx S1BG	Veneer gr 1 / White	2 070
		60 xx31xx S1BG	Veneer gr 2 / White	2 070
		60 xxxxxx S1BG	Veneer/veneer gr 1	2 358
		60 xxxxxx S1BG	Veneer/veneer gr 2	2 358
	Add. fee for base 1200x100x430 mm instead of adjustable furniture feet	60 31 70510	White direct lam.	131
		60 xx 70510	Veneer group 1	162
		60 xx 70510	Veneer group 2	162
WIDTH 1600 MM:				
	Unit 1600x420x430 mm (art 71710) including sliding doors (art 717081A) and clamping knobs (art 600006-19).	60 3131xx S1C1	White/white	1 044
		60 31xxxx S1C1	White/veneer gr 1	1 302
		60 31xxxx S1C1	White/veneer gr 2	1 302
		60 xx31xx S1C1	Veneer gr 1 / White	1 507
		60 xx31xx S1C1	Veneer gr 2 / White	1 507
		60 xxxxxx S1C1	Veneer/veneer gr 1	1 784
		60 xxxxxx S1C1	Veneer/veneer gr 2	1 784
	Unit 1600x821x430 mm (art 72710) including sliding doors (art 727081A) and clamping knobs (art 600006-19).	60 3131xx S1C2	White/white	1 283
		60 31xxxx S1C2	White/veneer gr 1	1 547
		60 31xxxx S1C2	White/veneer gr 2	1 547
		60 xx31xx S1C2	Veneer gr 1 / White	1 927
		60 xx31xx S1C2	Veneer gr 2 / White	1 927
		60 xxxxxx S1C2	Veneer/veneer gr 1	2 212
		60 xxxxxx S1C2	Veneer/veneer gr 2	2 212

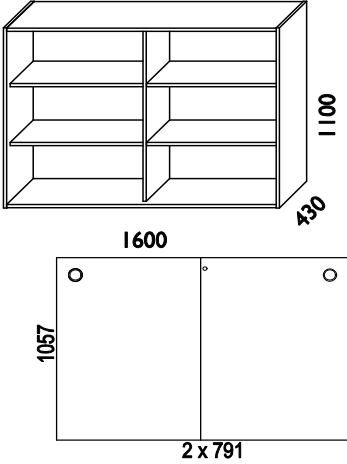
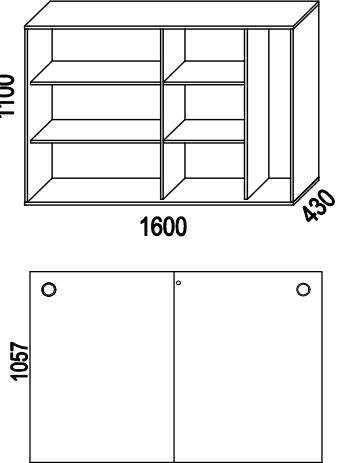
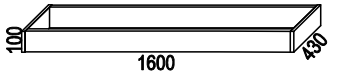
Illustration	Description	Article number	Material	EUR
	Unit 1600x1100x430 mm (art 73710) including sliding doors (art 737081A) and adjustable feet (art 600004-19).	60 3131xx S1C3	White/white	1 414
		60 31xxxx S1C3	White/veneer gr 1	1 766
		60 31xxxx S1C3	White/veneer gr 2	1 766
		60 xx31xx S1C3	Veneer gr 1 / White	2 101
		60 xx31xx S1C3	Veneer gr 2 / White	2 101
		60 xxxxxx S1C3	Veneer/veneer gr 1	2 479
		60 xxxxxx S1C3	Veneer/veneer gr 2	2 479
	Unit 1600x1100x430 mm with wardrobe (art 73712) including sliding doors (art 737081A) and adjustable feet (art 600004-19).	60 3131xx S1CG	White/white	1 663
		60 31xxxx S1CG	White/veneer gr 1	2 015
		60 31xxxx S1CG	White/veneer gr 2	2 015
		60 xx31xx S1CG	Veneer gr 1 / White	2 385
		60 xx31xx S1CG	Veneer gr 2 / White	2 385
		60 xxxxxx S1CG	Veneer/veneer gr 1	2 863
		60 xxxxxx S1CG	Veneer/veneer gr 2	2 863
	Add. fee for base 1600x100x430 mm instead of adjustable furniture feet	60 31 70710	White direct lam.	138
		60 xx 70710	Veneer group 1	207
		60 xx 70710	Veneer group 2	207



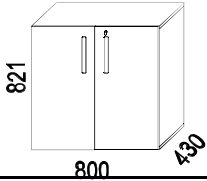
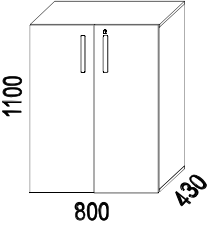
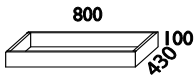
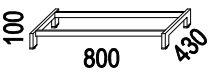
Illustration	Description	Article number	Material	EUR
Nomono Design: Fredrik Mattson				
<div style="display: flex; justify-content: space-between; align-items: flex-start;"> <div style="flex: 1;">  </div> <div style="flex: 2;"> <p>Nomono WITH HINGED DOORS</p> <ul style="list-style-type: none"> • Basic unit in direct laminated or veneered particleboard. • Hinged doors in lacquered or veneered MDF. Opening 110° • Including lock with 2 keys • Back in melamine • Stationary shelves • Fronts in optiona NCS: delivery time 6 weeks • Base not included, order separately • For additional product information please see www.horred.se <p>Material:</p> <p>Veneer group 1: Birch (05) Oak (03) Ash (06)</p> <p>Veneer group 2: White pigmented Oak (30) White pigmented Ash (10) Black stained Ash (86) Black stained Ash (76)</p> <p>White direct laminate and laquer: NCS S0300-N (31)</p> </div> <div style="flex: 1; text-align: right;">  <p>Colour handles / Closest NCS</p> <p>31 White S0300-N 37 Black S9000-N 32 Yellow S1070-Y 36 Green S2570-G30Y 33 Red S1580-Y80R 35 Turq.Blue S540-B30G 42 Orange S1080-Y50R xx * Elmosoft light brown 54035 * additional fee € 72..</p> </div> </div>				
	Storage 800x821x450 mm. 2 A4-height with hinged doors. <i>Upcharge for doors in optional NCS</i>	53 31xx 72340 53 xxxx 72340 53 xxxx 72340	White Veneer group 1 Veneer group 1	1 070 1 393 1 393 145
	Storage 800x1100x450 mm. 3 A4-height with hinged doors. <i>Upcharge for doors in optional NCS</i>	53 31xx 73340 53 xxxx 73340 53 xxxx 73340	White Veneer group 1 Veneer group 1	1 191 1 559 1 559 145
	Base 800x100x430 mm	57 31 70310 57 xxxx 70310 57 xxxx 70310	White Veneer group 1 Veneer group 1	122 141 141
	Leg base 800x100x430 mm, steel.	57 31 70330 57 37 70330	White Black	220 220



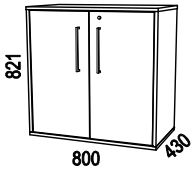
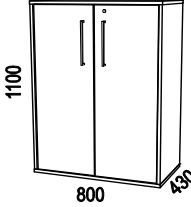
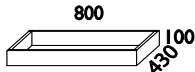
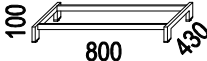
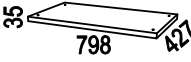



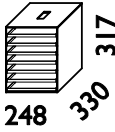
Illustration	Description	Article number	Material	EUR
VX				
VX WITH HINGED DOORS				
	<ul style="list-style-type: none"> • Basic unit in direct laminated or veneered particleboard. • Hinged doors in direct laminated particle board or veneered MDF. • Including lock with 2 keys. • Back in melamine • Stationary shelves • Base not included, order separately • For more product information; please see www.horreds.se 			
	<p>Material:</p> <p>Veneer group 1: birch (05), oak (03), ash (06)</p> <p>Veneer group 2: black ash (86), dark ash (76), white oak (30), white ash (10)</p>	<p>Colour handles</p> <p>31 White</p> <p>37 Black</p> <p>17 Stainless steel look</p>		
White direct laminatet: closest NCS S0300-N (31)				
	<p>Storage 800x821x430 mm.</p> <p>2 A4-height with hinged doors.</p> <p><i>Upcharge for doors in optional NCS</i></p>	<p>34 31xx 72330</p> <p>34 xxxx 72330</p> <p>34 xxxx 72330</p>	<p>White direct laminate</p> <p>Veneer group 1</p> <p>Veneer group 2</p>	<p>726</p> <p>1 273</p> <p>1 273</p> <p>238</p>
	<p>Storage 800x1100x430 mm.</p> <p>3 A4-height with hinged doors.</p> <p><i>Upcharge for doors in optional NCS</i></p>	<p>34 31xx 73330</p> <p>34 xxxx 73330</p> <p>34 xxxx 73330</p>	<p>White direct laminate</p> <p>Veneer group 1</p> <p>Veneer group 2</p>	<p>776</p> <p>1 367</p> <p>1 367</p> <p>238</p>
	<p>Base 800x100x430 mm</p>	<p>57 31 70310</p> <p>57 xx 70310</p> <p>57 xx 70310</p>	<p>White direct laminate</p> <p>Veneer group 1</p> <p>Veneer group 2</p>	<p>122</p> <p>141</p> <p>141</p>
	<p>Leg base 800x100x430 mm, steel.</p>	<p>57 31 70330</p> <p>57 37 70330</p>	<p>White</p> <p>Black</p>	<p>220</p> <p>220</p>
	<p>Castors. Height 100 mm.</p> <p>For 800 mm wide storage (4 castors of which 2 lockable).</p>	<p>57 31 70381</p> <p>57 xx 70381</p> <p>57 xx 70381</p>	<p>Grey/zink</p>	<p>65</p> <p>99</p> <p>99</p>
	<p>Base plate with small adjustable feet</p> <p>798x35x427 mm</p>	<p>39 08 28</p>	<p>White direct laminate</p> <p>Veneer group 1</p> <p>Veneer group 2</p>	<p>72</p>
	<p>Clamping knobs (4 pieces)</p>	<p>57 00 04</p>		<p>24</p>

Illustration	Description	Article number	Material	EUR
<p>ACCESSORIES TO STORAGE WITH DEPTH 43 CM</p> <p>• For more product information, see www.horreds.se</p>				
	<p>Insert in direct laminate with fronts in lacquer. 3 drawers. The top drawer is lockable.</p> <p><i>NB: does not fit VX width 80 cm with sliding doors.</i></p>	<p>57 31 076</p> <p>57 3199 076</p>	<p>White/white fronts</p> <p>White/opt.NCS fronts</p>	<p>364</p> <p>476</p>
	<p>Fits in all units with slidings doors and in Nomono with hinged doors.</p>	<p>35 57 31 03160</p>	<p>White</p>	<p>182</p>
	<p>C4-letter stack. Including 7 letter trays.</p>	<p>50 047 134</p>	<p>Black</p>	<p>72</p>

VX

VX Personal Storage

- Basic unit in white chipboard with direct laminate coating.
- Doors in white direct laminate (chipboard) or lacquered and
- Movable shelves are ordered separately.
- Bases are ordererd separately
- Knobs/handles are ordered separately.
- Cover plates and top shelves as options.
- Must be anchored to the wall due to tipping risk.
- When ordering, specify whether doores should be right-hung (A, B) or left-hung (C, D). If nothing is specified, they are delivered right-hung.
- Doors with knob/handle with/without lock have soft-closed hinges, not push-open.
- Electronic locks: Mifare 13,56 MHz incl. battery.
- Battery replacement is recommended at 2-year intervals.
- Configurator to quickly see the price for your desired setup; see www.horreds.se/Productst/Storage/Personal Stoage.



Basic units: White direct laminate, closest NCS S0300-N (31).






Doors white direct laminate: closest NCS S0300-N (31).

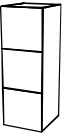



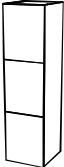



Doors Horreds optional NCS: see page 165

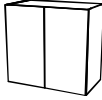
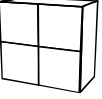
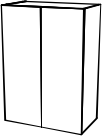
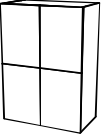
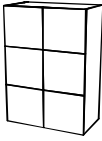
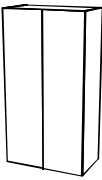
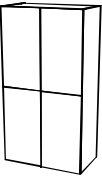
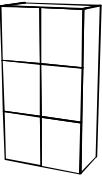

Doors customized optional NCS: Optional NCS (99).





Doors veneer group 1: Oak (03), Ash (06), White pigm. oak (30), White pigm. ash (10), Black stained ash (86), Dark stained ash (76), Burgundy ash (C8), Conifer ash (D3), Smokey Blue ash (D4), Olive ash (D6), Mushroom ash(D7).




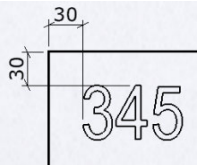



		<u>Door model</u>	<u>Article number</u>	<u>White</u>	<u>Horreds NCS</u>	<u>Optional NCS</u>	<u>Veneer</u>
	Storage white direct laminate 432x432x477mm (BxHxD) incl 1 door. <i>Upcharge opt. colour frame</i>	Push-open, no lock	34 xx A00 A11D	211	229	260	284
		Electronic lock	34 xx zyy A11A	386	404	435	459
		Code lock	34 xx zyy A11B	269	287	317	342
		Cylinder lock	34 xx zyy A11C	253	271	302	326
				79			
	Storage white direct laminate 432x864x477mm (BxHxD) incl 1 door. <i>Upcharge opt. colour frame</i>	Push-open, no lock	34 xx A00 A21D	237	275	300	351
		Electronic lock	34 xx zyy A21A	412	450	474	526
		Code lock	34 xx zyy A21B	295	332	357	409
		Cylinder lock	34 xx zyy A21C	280	317	342	393
				122			
	Storage white direct laminate 432x864x477mm (BxHxD) incl 2 doors and 1 fixed shelf. <i>Upcharge opt. colour frame</i>	Push-open, no lock	34 xx A00 A22D	315	350	412	460
		Electronic lock	34 xx zyy A22A	664	699	761	810
		Code lock	34 xx zyy A22B	429	465	526	575
		Cylinder lock	34 xx zyy A22C	399	434	496	544
				138			
	Storage white direct laminate 432x1296x477mm (BxHxD) incl 1 dörr. <i>Upcharge opt. colour frame</i>	Push-open, no lock	34 xx A00 A31D	319	374	407	503
		Electronic lock	34 xx zyy A31A	494	549	582	678
		Code lock	34 xx zyy A31B	377	432	464	560
		Cylinder lock	34 xx zyy A31C	361	416	449	545
				146			
	Storage white direct laminate 432x1296x477mm (BxHxD) incl 2 doors and 1 fixed shelf. <i>Upcharge opt. colour frame</i>	Push-open, no lock	34 xx A00 A32D	361	416	469	578
		Electronic lock	34 xx zyy A32A	711	765	818	928
		Code lock	34 xx zyy A32B	476	531	584	693
		Cylinder lock	34 xx zyy A32C	445	500	553	662
				162			

		<u>Door model</u>	<u>Article number</u>	<u>White</u>	<u>Horreds</u> <u>NCS</u>	<u>Optional</u> <u>NCS</u>	<u>Veneer</u>
	Storage white direct laminate 432x1296x477mm (BxHxD) incl 3 doors and 2 fixed shelves. <i>Upcharge opt. colour frame</i>	Push-open, no lock Electronic lock Code lock Cylinder lock	34 xx A00 A33D 34 xx zyy A33A 34 xx zyy A33B 34 xx zyy A33C	421 945 593 547 177	474 998 646 600	566 1 090 739 692	639 1 163 811 765
	Wardrobe white direct lam. 432x1296x477mm (BxHxD) incl 1 door, clothes rail, 1 movable shelf and rubber mat. <i>Upcharge opt. colour frame</i>	Push-open, no lock Electronic lock Code lock Cylinder lock	34 xx A00 A31DG 34 xx zyy A31AG 34 xx zyy A31BG 34 xx zyy A31CG	526 701 584 569 162	582 756 639 624	614 789 672 656	710 885 768 752
	Storage white direct laminate 432x1728x477mm (BxHxD) incl 1 door and 1 fixed shelf. <i>Upcharge opt. colour frame</i>	Push-open, no lock Electronic lock Code lock Cylinder lock	34 xx A00 A41D 34 xx zyy A41A 34 xx zyy A41B 34 xx zyy A41C	371 545 428 413 202	445 620 503 487	482 657 540 524	569 744 627 611
	Storage white direct laminate 432x1728x477mm (BxHxD) incl 2 doors and 1 fixed shelf. <i>Upcharge opt. colour frame</i>	Push-open, no lock Electronic lock Code lock Cylinder lock	34 xx A00 A42D 34 xx zyy A42A 34 xx zyy A42B 34 xx zyy A42C	402 751 516 486 202	476 826 591 560	526 875 641 610	629 978 744 713
	Storage white direct laminate 432x1728x477mm (BxHxD) incl 3 doors and 2 fixed shelves. <i>Upcharge opt. colour frame</i>	Push-open, no lock Electronic lock Code lock Cylinder lock	34 xx A00 A43D 34 xx zyy A43A 34 xx zyy A43B 34 xx zyy A43C	466 990 639 592 218	535 1 060 708 662	628 1 152 800 754	736 1 260 909 862
	Storage white direct laminate 432x1728x477mm (BxHxD) incl 4 doors and 2 fixed shelves. <i>Upcharge opt. colour frame</i>	Push-open, no lock Electronic lock Code lock Cylinder lock	34 xx A00 A44D 34 xx zyy A44A 34 xx zyy A44B 34 xx zyy A44C	524 1 223 753 692 234	595 1 294 824 763	718 1 417 948 886	815 1 514 1 045 983
	Wardrobe white direct lam. 432x1728x477mm (BxHxD) incl 1 door, clothes rail, 1 movable shelf and rubber mat. <i>Upcharge opt. colour frame</i>	Push-open, no lock Electronic lock Code lock Cylinder lock	34 xx A00 A41DG 34 xx zyy A41AG 34 xx zyy A41BG 34 xx zyy A41CG	588 762 645 630 202	662 837 720 704	699 874 756 741	786 961 843 828
	Storage white direct laminate 864x432x477mm (BxHxD) incl 2 doors. <i>Upcharge opt. colour frame</i>	Push-open, no lock Electronic lock Code lock Cylinder lock	34 xx A00 B12D 34 xx zyy B12A 34 xx zyy B12B 34 xx zyy B12C	367 716 482 451 134	402 752 517 486	464 813 579 548	512 862 627 596

	Storage white direct laminate 864x864x477mm (BxHxD) incl 2 doors.. <i>Upcharge opt. colour frame</i>	Push-open, no lock	Article number	White	Horreds NCS	Optional NCS	Veneer
		Electronic lock	34 xx A00 B22D	414	489	538	641
Code lock	34 xx zyy B22A	763	838	888	991		
Cylinder lock	34 xx zyy B22B	529	604	653	756		
Cylinder lock	34 xx zyy B22C	498	573	623	726		
				212			
	Storage white direct laminate 864x864x477mm (BxHxD) incl 4 doors and 2 fixed shelf. <i>Upcharge opt. colour frame</i>	Push-open, no lock	34 xx A00 B24D	565	636	759	856
Electronic lock	34 xx zyy B24A	1 264	1 335	1 458	1 555		
Code lock	34 xx zyy B24B	795	866	989	1 086		
Cylinder lock	34 xx zyy B24C	733	804	928	1 025		
				244			
	Storage white direct laminate 864x1296x477mm (BxHxD) incl 2 doors. <i>Upcharge opt. colour frame</i>	Push-open, no lock	34 xx A00 B32D	535	646	711	903
Electronic lock	34 xx zyy B32A	885	995	1 060	1 252		
Code lock	34 xx zyy B32B	650	761	826	1 018		
Cylinder lock	34 xx zyy B32C	620	730	795	987		
				247			
	Storage white direct laminate 864x1296x477mm (BxHxD) incl 4 doors and 2 fixed shelf. <i>Upcharge opt. colour frame</i>	Push-open, no lock	34 xx A00 B34D	659	768	874	1 092
Electronic lock	34 xx zyy B34A	1 358	1 466	1 573	1 791		
Code lock	34 xx zyy B34B	888	997	1 104	1 322		
Cylinder lock	34 xx zyy B34C	827	936	1 042	1 260		
				279			
	Storage white direct laminate 864x1296x477mm (BxHxD) incl 6 doors and 4 fixed shelf. <i>Upcharge opt. colour frame</i>	Push-open, no lock	34 xx A00 B36D	781	887	1 072	1 218
Electronic lock	34 xx zyy B36A	1 829	1 936	2 120	2 266		
Code lock	34 xx zyy B36B	1 125	1 232	1 417	1 562		
Cylinder lock	34 xx zyy B36C	1 033	1 140	1 324	1 470		
			XX	310			
	Storage white direct laminate 864x1728x477mm (BxHxD) incl 2 doors and 2 fixed shelves. <i>Upcharge opt. colour frame</i>	Push-open, no lock	34 xx A00 B42D	660	809	883	1 057
Electronic lock	34 xx zyy B42A	1 009	1 158	1 232	1 406		
Code lock	34 xx zyy B42B	775	924	997	1 172		
Cylinder lock	34 xx zyy B42C	744	893	967	1 141		
				356			
	Storage white direct laminate 864x1728x477mm (BxHxD) incl 4 doors and 2 fixed shelves. <i>Upcharge opt. colour frame</i>	Push-open, no lock	34 xx A00 B44D	718	793	967	1 173
Electronic lock	34 xx zyy B44A	1 417	1 492	1 666	1 872		
Code lock	34 xx zyy B44B	948	1 023	1 197	1 403		
Cylinder lock	34 xx zyy B44C	887	961	1 135	1 342		
				356			
	Storage white direct laminate 864x1728x477mm (BxHxD) incl 6 doors and 4 fixed shelves. <i>Upcharge opt. colour frame</i>	Push-open, no lock	34 xx A00 B46D	851	990	1 174	1 391
Electronic lock	34 xx zyy B46A	1 899	2 038	2 223	2 440		
Code lock	34 xx zyy B46B	1 196	1 334	1 519	1 736		
Cylinder lock	34 xx zyy B46C	1 103	1 242	1 427	1 644		
				388			
	Storage white direct laminate 864x1728x477mm (BxHxD) incl 8 doors and 6 fixed shelves. <i>Upcharge opt. colour frame</i>	Push-open, no lock	34 xx A00 B48D	975	1 117	1 363	1 558
Electronic lock	34 xx zyy B48A	2 373	2 515	2 761	2 956		
Code lock	34 xx zyy B48B	1 434	1 577	1 823	2 017		
Cylinder lock	34 xx zyy B48C	1 311	1 453	1 700	1 894		
				419			

BASES						
		Article number	White	Horreds NCS	Optional NCS	Veneer
	Single base in white direct laminate Selectable material in the front. 430x150x454mm, Incl. adjustable feet	34 xx A10	97	117	128	132
	Double base in white direct laminate Selectable material in the front. 862x150x454mm, Incl adjustable feet.	34 xx A20	105	127	139	147
KNOBS AND HANDLES						
			Priser per dörr			
	Knob, lettered, Ø17mm, height 28mm Available in black, stainless look and brass look.	D-x		Black (343315-11)	Stainless (34331-11)	Brass (343316-11)
				11	11	11
	Knob, Ø28mm, height 24mm Available in matte white, matte black, stainless look and brass look.	C-x	White (31)	Black (20332400SP)	Stainless (17)	Brass (16)
			8	8	8	8
	Milled down handle, ø45mm, with backing handle plate. Not for doors in direct laminate.	B-x		Horreds NCS	Optional NCS	Veneer
				39	44	50
ACCESSORIES						
			white dir. laminate	Optional colour		
	Movable shelf 400x448.5mm. For width 432mm.	34 31 09449	221	42		
	Movable shelf 400x448.5mm. For width 864mm.	34 31 09470	221	42		
	Removable, shallow shelf 400x402mm. For unit width 432mm. Used in combination with keyboard holder only.	34 31 09479	221	42		
	Removable, shallow shelf 408x402mm. Till unit width 864mm. Used in combination with keyboard holder only.	34 31 09481	221	42		
	Keyboard holder in felt. Inner meas.: W230/D35/H210/80 mm. Attach on inside door. NB: not in combination with the smallest door 432x432 mm.	34 98 08327	(Antracit) 57			

			White	Horreds NCS	Optional NCS	Veneer
	Shoe shelf 432x270x477mm, including black, rifled rubber mat.	34 xx A001	182	252	313	495
	Shoe shelf 864x270x477mm, including black, rifled rubber mat.	34 xx A002	288	348	420	686
	Add-on module 840x195mm, depth 480mm. Including 2 plastic plant containers, recycled plastic, each 790x140x170/115 mm.	34 xx 09480	296	402	487	589
	Seat cushion: contact us for quotation.					
	Foiling numbers Arial 188pt Foil figures, not assembled, price per piece Foil figures, assembled, price per piece	34 37 -F03 34 37 FM03				Black 7 27
	Portable storage box incl pen tray L343/B223/H240 mm.	34 37 06018				52
	User card for electronic lock	371781				16
	Battery for electronic lock Flexlock. Replacment is recommended to be done at a 2 years interval. In order to have your Flexlock work optimally it is required to use this Flexlock battery.	376691				19

<p align="center">COVER PANEL TOP</p> <p align="center">• Thickness 19mm</p> <p align="center">• Max length top panel is 5 x door width = 2160mm. For wider sietups than 5 x door width, the top panel is split.</p>					
			<u>Horreds NCS</u>	<u>Optional NCS</u>	<u>Veneer</u>
	Top panel, depth 485mm, price per door width		66	96	110
	Top panel, depth 967mm, price per door width		89	131	152
<p align="center">COVER PANEL SIDE</p> <p align="center">• Thickness 19mm</p>					
	Side panel, 419x482mm		66	96	110
	Side panel, 581x482mm		66	96	110
	Side panel, 851x482mm		132	192	219
	Side panel, 1013x482mm		132	192	219
	Side panel, 1283x482mm		199	288	329
	Side panel, 1445x482mm		199	288	329
	Side panel, 1715x482mm		265	384	438
	Side panel, 1877x482mm		265	384	438
	Side panel, 2147x482mm		298	432	493
	Side panel, 419x964mm		89	131	152
	Side panel, 581x964mm		89	131	152
	Side panel, 851x964mm		179	262	304
	Side panel, 1013x964mm		179	262	304
	Side panel, 1283x964mm		268	393	457
	Side panel, 1445x964mm		268	393	457
	Side panel, 1715x964mm		358	524	609
	Side panel, 1877x964mm		358	524	609
	Side panel, 2147x964mm		402	589	685



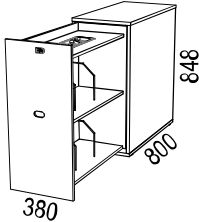
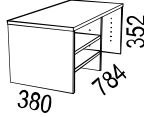
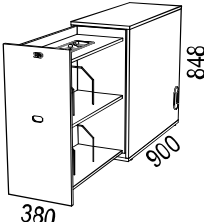

Illustration	Description	Article number	Material	EUR
<p>Biblio Design: Anderssen & Voll</p>				
	<p>Biblio Side Storage</p> <ul style="list-style-type: none"> • Side storage in direct laminated or veneered particle board. • Front in lacquered or veneered MDF with handles in veneered steel. • The inside is always white. • Stationary shelves. • With clamping knobs. • Max weight capacity: 50 kg. • Lockable. • Chose left or right; images below show units for placement on left side of desk • Can be easily rebuilt from left to right and vice versa. • Note: Dimensions and design changed from 2022. • For additional product information: please see www.horreds.se <p>Material: <u>Veneer group 1:</u> Oak (03), Ash (06) <u>Veneer group 2:</u> Blackst.ash (86), Darkst. ash (76), White pigm.oak(30), White pigm.ash (10) <u>White direct laminate:</u> closest NCS S0300-N</p>	 <p>Colour handles: 03 Oak 06 Ash 75 Black ash 76 Dark ash 30 White Oak 10 White ash 31 White (RAL 9016)</p>		
 	<p>Biblio side storage height 2xA4. <u>Depth 800 mm.</u> Incl.pen tray and brackets.</p> <p><i>Upcharge for front in optional NCS</i> <i>Upcharge for veneered front to white unit</i></p> <p>Open top storage height 1xA4.</p> <p><i>Article numer for side storage prepared for top storage</i></p>	<p>64 3131xx 11BV/H 64 xxxxxx 11BV/H 64 xxxxxx 11BV/H</p> <p>57 31 06400 57 xx 06400 57 xx 06400</p> <p>64 xx 11DV/H</p>	<p>White Veneer group 1 Veneer group 2</p>	<p>1 159 1 759 1 759 238 238 327 641 641</p>
 	<p>Biblio side storage height 2xA4. <u>Depth 900 mm.</u> Incl.pen tray and brackets.</p> <p><i>Upcharge for front in optional NCS</i> <i>Upcharge for veneered front to white unit</i></p> <p>Open top storage height 1xA4.</p> <p><i>Article numer for side storage prepared for top storage</i></p>	<p>64 3131xx 12BV/H 64 xxxxxx 12BV/H 64 xxxxxx 12BV/H</p> <p>57 31 06410 57 xx 06410 57 xx 06410</p> <p>64 xx 12DV/H</p>	<p>White Veneer group 1 Veneer group 2</p>	<p>1 230 1 776 1 776 238 238 341 663 663</p>

Illustration	Description	Article number	Material	EUR
	Biblio side storage height 3xA4. <u>Depth 800 mm.</u> Incl.pen tray and brackets. <i>Upcharge for front in optional NCS</i> <i>Upcharge for veneered front to white unit</i>	64 3131xx 21BV/H	White	1 304
		64 xxxxxx 21BV/H	Veneer group 1	1 847
		64 xxxxxx 21BV/H	Veneer group 2	1 847
				238
				238
	Biblio side storage height 3xA4. <u>Depth 900 mm.</u> Incl.pen tray and brackets. <i>Upcharge for front in optional NCS</i> <i>Upcharge for veneered front to white unit</i>	64 3131xx 22BV/H	White	1 375
		64 xxxxxx 22BV/H	Veneer group 1	1 865
		64 xxxxxx 22BV/H	Veneer group 2	1 865
				238
				238
<h3>BIBLIO SPLIT</h3> <ul style="list-style-type: none"> • For 2 users. To be placed between two desks.. • The inside is always white. • Stationary shelves. • Max weight capacity 50 kg. • Not lockable. • Inserts and Hanging file drawer do not fit in Split. 				
	Biblio Split height 3xA4. <u>Depth 800 mm.</u> <i>Upcharge for front in optional NCS</i> <i>Upcharge for veneered front to white unit</i>	64 3131xx 21A	White	1 578
		64 xxxxxx 21A	Veneer group 1	2 120
		64 xxxxxx 21A	Veneer group 2	2 120
				238
				238
	Biblio Split height 3xA4. <u>Depth 900 mm.</u> <i>Upcharge for front in optional NCS</i> <i>Upcharge for veneered front to white unit</i>	64 3131xx 22A	White	1 648
		64 xxxxxx 22A	Veneer group 1	2 139
		64 xxxxxx 22A	Veneer group 2	2 139
				238
				238



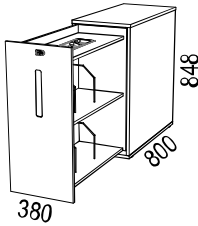
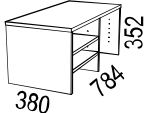
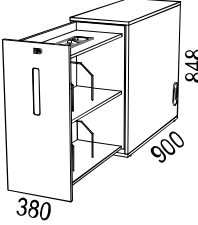
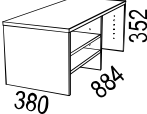
Illustration	Description	Article number	Material	EUR
Nomono Design: Fredrik Mattson				
	<p>Nomono Side Storage</p> <ul style="list-style-type: none"> • Side storage in direct laminated or veneered particle board. • Front in lacquered or veneered MDF with handles in lacquered steel sheet. • The inside is always white. • Stationary shelves. • With clamping knobs. • Max weight capacity: 50 kg. • Lockable. • Chose left or right; images below show units for placement on left side of desk • Can be easily rebuilt from left to right and vice versa. • Note: Dimensions and design changed from 2022. • For additional product information: please see www.horreds.se <p>Material:</p> <p><u>Veneer group 1:</u> Oak (03), Ash (06)</p> <p><u>Veneer gr. 2:</u> Black ash (86), Dark Ash (76), White oak (30), White ash (10)</p> <p><u>White direct laminate:</u> Closest NCS 0300-N</p> <p>Handle in light brown Elmosoft 54035, upcharge € 36.</p>	 <p>Colour handles:</p> <p>31 White</p> <p>37 Black</p> <p>32 Yellow</p> <p>36 Green</p> <p>33 Red</p> <p>35 Blue</p> <p>42 Orange</p>	<p>Closest ncs:</p> <p>S 0300-N</p> <p>S 9000-N</p> <p>S 1070-Y</p> <p>S 2570-G30Y</p> <p>S 1580-Y80R</p> <p>S 0540-B30G</p> <p>S 1080-Y50R</p>	
 	<p>Nomono side storage height 2xA4. <u>Depth 800 mm.</u> Incl.pen tray and brackets.</p> <p><i>Upcharge for front in optional NCS</i> <i>Upcharge for veneered front to white unit</i></p> <p>Open top storage height 1xA4.</p> <p><i>Article numer for side storage prepared for top storage</i></p>	<p>52 3131xx 11BV/H</p> <p>52 xxxxxx 11BV/H</p> <p>52 xxxxxx 11BV/H</p> <p>57 31 06400</p> <p>57 xx 06400</p> <p>57 xx 06400</p> <p>52 xx 11DV/H</p>	<p>White</p> <p>Veneer group 1</p> <p>Veneer group 2</p> <p>White</p> <p>Veneer group 1</p> <p>Veneer group 2</p>	<p>1 136</p> <p>1 736</p> <p>1 736</p> <p>238</p> <p>238</p> <p>327</p> <p>641</p> <p>641</p>
 	<p>Nomono side storage height 2xA4. <u>Depth 900 mm.</u> Incl.pen tray and brackets.</p> <p><i>Upcharge for front in optional NCS</i> <i>Upcharge for veneered front to white unit</i></p> <p>Open top storage height 1xA4.</p> <p><i>Article numer for side storage prepared for top storage</i></p>	<p>52 3131xx 12BV/H</p> <p>52 xxxxxx 12BV/H</p> <p>52 xxxxxx 12BV/H</p> <p>57 31 06410</p> <p>57 xx 06410</p> <p>57 xx 06410</p> <p>52 xx 12DV/H</p>	<p>White</p> <p>Veneer group 1</p> <p>Veneer group 2</p> <p>White</p> <p>Veneer group 1</p> <p>Veneer group 2</p>	<p>1 207</p> <p>1 753</p> <p>1 753</p> <p>238</p> <p>238</p> <p>341</p> <p>663</p> <p>663</p>

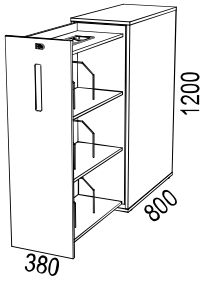
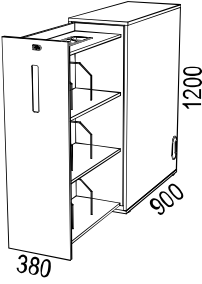
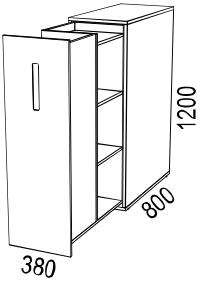
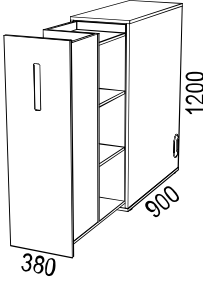
Illustration	Description	Article number	Material	EUR
	Nomono side storage height 3xA4. <u>Depth 800 mm.</u> Incl.pen tray and brackets. <i>Upcharge for front in optional NCS</i> <i>Upcharge for veneered front to white unit</i>	52 3131xx 21BV/H	White	1 281
		52 xxxxxx 21BV/H	Veneer group 1	1 824
		52 xxxxxx 21BV/H	Veneer group 2	1 824
				238
				238
	Nomono side storage height 3xA4. <u>Depth 900 mm.</u> Incl.pen tray and brackets. <i>Upcharge for front in optional NCS</i> <i>Upcharge for veneered front to white unit</i>	52 3131xx 22BV/H	White	1 352
		52 xxxxxx 22BV/H	Veneer group 1	1 842
		52 xxxxxx 22BV/H	Veneer group 2	1 842
				238
				238
<h3>NOMONO SPLIT</h3> <ul style="list-style-type: none"> • For 2 users. To be placed between two desks.. • The inside is always white. • Stationary shelves. • Max weight capacity 50 kg. • Not lockable. • Inserts and Hanging file drawer do not fit in Split. 				
	Nomono Split height 3xA4. <u>Depth 800 mm.</u> <i>Upcharge for front in optional NCS</i> <i>Upcharge for veneered front to white unit</i>	52 3131xx 21A	White	1 555
		52 xxxxxx 21A	Veneer group 1	2 097
		52 xxxxxx 21A	Veneer group 2	2 097
				238
				238
	Nomono Split height 3xA4. <u>Depth 900 mm.</u> <i>Upcharge for front in optional NCS</i> <i>Upcharge for veneered front to white unit</i>	52 3131xx 22A	White	1 625
		52 xxxxxx 22A	Veneer group 1	2 116
		52 xxxxxx 22A	Veneer group 2	2 116
				238
				238

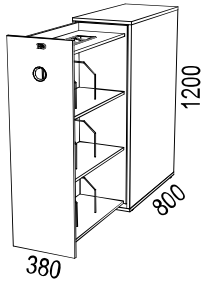
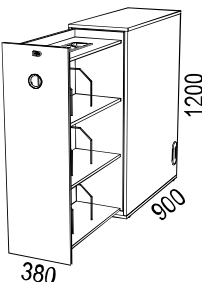
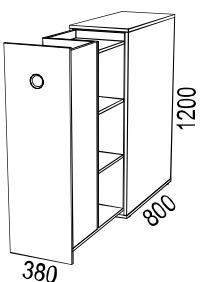
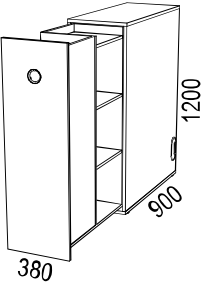
Illustration	Description	Article number	Material	EUR
	Siglo side storage height 3xA4. <u>Depth 800 mm.</u> Incl.pen tray and brackets. <i>Upcharge for front in optional NCS</i> <i>Upcharge for veneered front to white unit</i>	60 3131xx 21BV/H	White dir.lam.	1 243
		60 xxxxxx 21BV/H	Veneer group 1	1 850
		60 xxxxxx 21BV/H	Veneer group 2	1 850
				267
				267
	Siglo side storage height 3xA4. <u>Depth 900 mm.</u> Incl.pen tray and brackets. <i>Upcharge for front in optional NCS</i> <i>Upcharge for veneered front to white unit</i>	60 3131xx 22BV/H	White dir.lam.	1 318
		60 xxxxxx 22BV/H	Veneer group 1	1 869
		60 xxxxxx 22BV/H	Veneer group 2	1 869
				267
				267
<h3>SIGLO SPLIT</h3> <ul style="list-style-type: none"> • For 2 users. To be placed between two desks.. • The inside is always white. • Stationary shelves. • Max weight capacity 50 kg. • Not lockable. • Inserts and Hanging file drawer do not fit in Split. 				
	Siglo Split height 3xA4. <u>Depth 800 mm.</u> <i>Upcharge for front in optional NCS</i> <i>Upcharge for veneered front to white unit</i>	60 3131xx 21A	White dir.lam.	1 534
		60 xxxxxx 21A	Veneer group 1	2 141
		60 xxxxxx 21A	Veneer group 2	2 141
				267
				267
	Siglo Split height 3xA4. <u>Depth 900 mm.</u> <i>Upcharge for front in optional NCS</i> <i>Upcharge for veneered front to white unit</i>	60 3131xx 22A	White dir.lam.	1 609
		60 xxxxxx 22A	Veneer group 1	2 160
		60 xxxxxx 22A	Veneer group 2	2 160
				267
				267

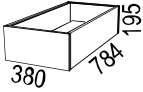
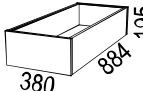
Illustration	Description	Article number	Material	EUR
ACCESSORIES TO SIGLO SIDE STORAGE				
	Add-on module in wood 380x784x195 mm incl. 1 plant container á 170x590x140 mm in recycled plastic	60 31 06365-1 60 xx 06365-1 60 xx 06365-1	White Veneer group 1 Veneer group 2	357 626 626
	Add-on module in wood 380x884x195 mm incl. 1 plant container á 170x790x140 mm in recycled plastic	60 31 06365-2 60 xx 06365-2 60 xx 06365-2	White Veneer group 1 Veneer group 2	357 626 626



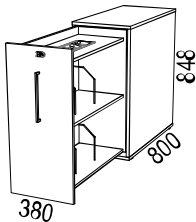
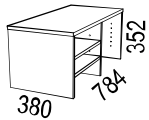
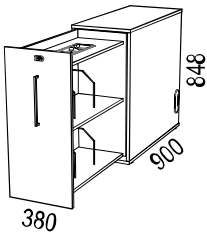
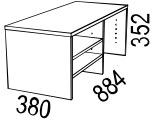
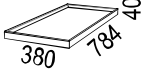
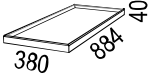

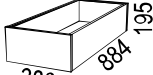


Illustration	Description	Article number	Material	EUR
VX				
<div style="display: flex; justify-content: space-between;"> <div style="width: 25%;">  </div> <div style="width: 50%;"> <h3 style="margin: 0;">VX Side Storage</h3> <ul style="list-style-type: none"> Side storage in direct laminated or veneered particle board. The inside is always white. Stationary shelves. With clamping knobs. Max weight capacity: 50 kg. Lockable. Chose left or right; images below show units for placement on left side of desk Can be easily rebuilt from left to right and vice versa. For additional product information; please see www.horreds.se </div> <div style="width: 20%; text-align: center;">  </div> </div> <div style="margin-top: 20px;"> <p>Material:</p> <p><u>Veneer group 1:</u> Birch (05), Oak (03), Ash (06)</p> <p><u>Veneer group 2:</u> Blackst.ash (86), Darkst. ash (76), White pigm.oak(30), White pigm.ash (10)</p> <p><u>White direct laminate:</u> closest NCS S0300-N</p> </div> <div style="margin-top: 20px;"> <p>Colour handles:</p> <p>31 White</p> <p>37 Black</p> <p>17 Stanless steel look</p> </div>				
 	<p>VX side storage height 2xA4. <u>Depth 800 mm.</u> Incl.pen tray and brackets.</p> <p><i>Upcharge for front in optional NCS</i> <i>Upcharge for veneered front to white unit</i></p> <p>Open top storage height 1xA4.</p> <p><i>Article numer for side storage prepared for top storage</i></p>	<p>34 3131xx 11BV/H</p> <p>34 xxxxxx 11BV/H</p> <p>34 xxxxxx 11BV/H</p> <p>57 31 06400</p> <p>57 xx 06400</p> <p>57 xx 06400</p> <p>34 xx 11DV/H</p>	<p>White dir.lam.</p> <p>Veneer group 1</p> <p>Veneer group 2</p> <p>White dir.lam.</p> <p>Veneer group 1</p> <p>Veneer group 2</p>	<p>970</p> <p>1 481</p> <p>1 481</p> <p>238</p> <p>238</p> <p>327</p> <p>641</p> <p>641</p>
 	<p>VX side storage height 2xA4. <u>Depth 900 mm.</u> Incl.pen tray and brackets.</p> <p><i>Upcharge for front in optional NCS</i> <i>Upcharge for veneered front to white unit</i></p> <p>Open top storage height 1xA4.</p> <p><i>Article numer for side storage prepared for top storage</i></p>	<p>34 3131xx 12BV/H</p> <p>34 xxxxxx 12BV/H</p> <p>34 xxxxxx 12BV/H</p> <p>57 31 06410</p> <p>57 xx 06410</p> <p>57 xx 06410</p> <p>34 xx 12DV/H</p>	<p>White dir.lam.</p> <p>Veneer group 1</p> <p>Veneer group 2</p> <p>White dir.lam.</p> <p>Veneer group 1</p> <p>Veneer group 2</p>	<p>1 037</p> <p>1 499</p> <p>1 499</p> <p>238</p> <p>238</p> <p>341</p> <p>663</p> <p>663</p>

Illustration	Description	Article number	Material	EUR
	VX side storage height 3xA4. <u>Depth 800 mm.</u> Incl.pen tray and brackets. <i>Upcharge for front in optional NCS</i> <i>Upcharge for veneered front to white unit</i>	34 3131xx 21BV/H	White dir.lam.	1 109
		34 xxxxxx 21BV/H	Veneer group 1	1 650
		34 xxxxxx 21BV/H	Veneer group 2	1 650
				238
				238
	VX side storage height 3xA4. <u>Depth 900 mm.</u> Incl.pen tray and brackets. <i>Upcharge for front in optional NCS</i> <i>Upcharge for veneered front to white unit</i>	34 3131xx 22BV/H	White dir.lam.	1 176
		34 xxxxxx 22BV/H	Veneer group 1	1 668
		34 xxxxxx 22BV/H	Veneer group 2	1 668
				238
				238
VX SPLIT				
<ul style="list-style-type: none"> • For 2 users. To be placed between two desks.. • The inside is always white. • Stationary shelves. • Max weight capacity 50 kg. • Not lockable. • Inserts and Hanging file drawer do not fit in Split. 				
	VX Split height 3xA4. <u>Depth 800 mm.</u> <i>Upcharge for front in optional NCS</i> <i>Upcharge for veneered front to white unit</i>	34 3131xx 21A	White dir.lam.	1 369
		34 xxxxxx 21A	Veneer group 1	1 910
		34 xxxxxx 21A	Veneer group 2	1 910
				238
				238
	VX Split height 3xA4. <u>Depth 900 mm.</u> <i>Tillägg för lackad front i valfri NCS</i> <i>Tillägg för fanerad front (stomme i dir.lam)</i>	34 3131xx 22A	White dir.lam.	1 436
		34 xxxxxx 22A	Veneer group 1	1 928
		34 xxxxxx 22A	Veneer group 2	1 928
				238
				238

Illustration	Description	Article number	Material	EUR
ACCESSORIES TO SIDE STORAGE				
	Tray 380x784x40 mm	64 xx 08750-080	Veneer group 1	489
		64 xx 08750-080	Veneer group 2	489
	Tray 380x884x40 mm	64 xx 08750-090	Veneer group 1	489
		64 xx 08750-090	Veneer group 2	489
	Add-on module in wood 380x784x195 mm incl. 1 plant container á 170x590x140 mm in recycled plastic	57 31 06365-1	White dir.lam.	320
		57 xx 06365-1	Veneer gr 1	562
		57 xx 06365-1	Veneer gr 1	562
	Add-on module in wood 380x884x195 mm incl. 1 plant container á 170x790x140 mm in recycled plastic	57 31 06365-2	White dir.lam.	320
		57 xx 06365-2	Veneer gr 1	562
		57 xx 06365-2	Veneer gr 1	562
	Hanging file drawer, assembled on expansion track <i>Does not fit in Split.</i>	57 31 03160	White	182
	Shallow insert in direct laminate with fronts in lacquer. 2 drawers. The top drawer incl a plastic pen drawer. <i>Does not fit in Split.</i>	57 31 082	White/White	301
		57 3199 082	White/Opt.NCS fronts	413

MEETING TABLES INFO



Here is a presentation of our various stands for meeting tables.

Information regarding table tops, see next page.

VX Conference

- Fixed T-leg stand in height 73 and 90 cm. White RAL9016 and black RAL 9005.
- Electric T-leg stand in height 70-120 cm for format MA, others formats 73-110 cm. White RAL9016 and black RAL 9005. Lifting speed 80mm/s, lifting force 800N/leg, anti-collision, PVC- and PFAS-free system. 0,1w power consumption in standby mode, 10 years warranty.
- Tables in format MA (max. width 90 cm) is delivered with T-legs in dimension 80x50 mm with standard T-foot 70 cm. Solid foot as an option. Cable entries \varnothing 80 mm and Powerdots max \varnothing 60 mm are suitable for these tables.
- Tables in format MF, MG and MH (max. width 120 cm) are delivered with T-legs in dimension 80x50 mm with solid T-foot 70 cm.
- Tables in formats MG+ and MH+ (width 130-140 cm) are delivered with T-legs in dimension 70x70 mm with solid T-foot 90 cm.



VX Project

- Square legs (7x7cm) in metal or solid wood (standard).
- Round legs (\varnothing 10cm) in solid wood.
- Metal legs: White RAL9016, Black RAL9005 and 8 optional colours.
- Wooden legs: oak (03), ash (06), white oak (30), white ash (10), black ash (86), dark ash (76), Burgundy stained ash (C8), Conifer stained ash (D3), Smokey Blue stained ash (D4), Olive stained ash (D6) and Mushroom stained ash (D7)
- Steel frame (white / black) or anodized aluminum frame.
- Table height 73 and 90 cm.
- Minimum width in standard version is 120 cm due to legroom and cable hole limitations. If you are interested in a table in width 100 or 90 cm; contact us for a proposal/quote.

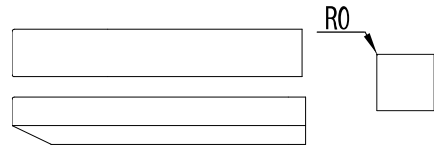


Optional colours metal legs:

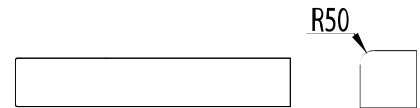
1019 Grey beige (3H)	Optional colour VX projekt
1024 Ochre yellow (3G)	Optional colour VX projekt
3007 Black red (3D)	Optional colour VX projekt
5008 Grey blue (3C)	Optional colour VX projekt
6009 Fir green (3L)	Optional colour VX projekt
6013 Reed green (3K)	Optional colour VX projekt
7039 Quartz grey (3J)	Optional colour VX projekt
7044 Silk grey (3A)	Optional colour VX projekt
9005 Jet black (37)	Standard VX Conference T-legs and VX Project
9016 Traffic white (31)	Standard VX Conference T-legs and VX Project

Tabletops:**VX**

- VX desk tops are made of 19 mm MDF with edging in matching colour.
- Option: chamfered edge
- Corner radius 0 mm.

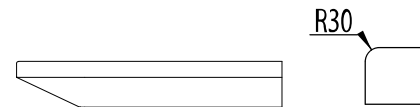
**VX radius 50**

- VX desk tops with rounded corners are made of 19 mm MDF with edging in matching colour
- Corner radius 50

**Fri**

Design: Bror Boije

- Fri desk tops are made of 19 mm MDF with chamfered, clear coated edge.
- Corner radius 30 mm.

**Table material:****High pressure laminate:**

White HPL 0754 (31)	Closest NCS: S0502-Y
Light grey HPL 0419 (2A)	S2002-Y
Light grey HPL1365 (2B)	S2005-R80B
Medium grey HPL 1023 (2C)	S5500-N
Anthracite HPL 1397 (2D)	S7500-N
Black HPL 2253 (2E)	S9000-N

Direct laminate:

White (31D)	NCS 0300-N
-------------	------------

Linoleum:

4132 Ash	Closest NCS: 5502-G
4154 Burgundy	7010-R10B
4166 Charcoal	8502-B
4172 Mauve	7005-Y80R
4174 Conifer	8010-B90G
4175 Pebble	3502-Y
4176 Mushroom	2002-Y
4177 Vapour	2005-G10Y
4179 Smokey Blue	7010-R90B
4184 Olive	5010-G50Y

Veneer group 1:

Birch* (05)
Oak (03)
Ash (06)

Veneer group 2:

White pigm. oak (30)**
Black stained ash (86)**
White pigmented ash (10)**
Dark stained ash (76)**
Burgundy ash (C8)**
Conifer ash (D3)**
Smokey Blue ash (D4)**
Olive ash(D6)*
Mushroom ash ash (D7)*

**=*not Henry*

- For more product information see www.horreds.se

MEETING TABLES**MA**

Meeting tables within size 2000x900 mm.

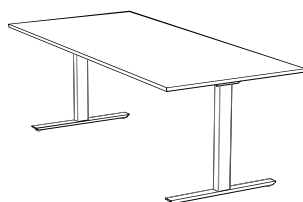
VX T-legs are delivered with 700 mm standard foot, massive foot as option.

This format is not possible with a centered cable cover.

When ordering, state the desired table size, profile, material and colour and height of the stand.

Table top (excluding legs)	White laminate (HPL)	Optional laminate (HPL)	Linoleum	Veneer group 1	Veneer group 2
Series: Radius: Edge profile:					
VX (3416) * 0 mm Straight / matching list	497	610	723	503	503
VX (3417) * 0 mm Chamfered / matching list	612	725	839	618	618
VX (3418) * 50 mm Straight / matching list	531	648	812	544	544
Fri (3513) 30 mm Chamfered / MDF	544	662	825	501	501
* Upcharge for veneer edging on laminate	107	107			
* Upcharge for veneer edging on linoleum. Note: Only oak/ash nature and white pigmented. Not possible on stained tables.			107		
Possible cable entry: max ø 80 and Powerdot max ø 60 mm.					

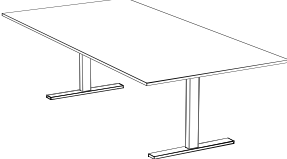
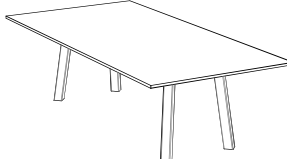
Stand (exclusive tabletop):	White (31) Black (37)
VX T-legs fixed table height 73cm	620
VX T-legs fixed table height 90cm	648
VX T-legs electrical 61-126 cm	1 229
Upcharge for massive feet	208

VX T-legs

Sizes:

Längd 1800-2000 mm

Bredd 900 mm

MEETING TABLES							
<h1>MF</h1> Meeting tables within size 2400x1200 mm.							
VX T-legs are delivered with solid steel foot 700 mm. VX Project Stand is delivered with slanted legs in wood or metal. When ordering, state the desired table size, profile, material and colour and height of the stand.							
Table top (excluding legs)	White direct lam.	White laminate (HPL)	Optional laminate (HPL)	Linoleum	Veneer group 1	Veneer group 2	
Series: VX (3416) * VX (3417) * VX (3418) * Fri (3513)	Radius: 0 mm 0 mm 50 mm 30 mm	Edge profile: Straight / matching list Chamfered / matching list Straight / matching list Chamfered / MDF	681 718 717 756	717 754 755 794 107	773 810 814 853 107	1 149 1 186 1 209 1 248 107	827 874 870 920
* Upcharge for veneer edging on laminate * Upcharge for veneer edging on linoleum. Note: Only oak/ash nature and white pigmented. Not possible on stained tables.							
Stand (excluding table top):				White (31) Black (37)	Optional colours	Oak (03) Ash (06)	
VX Conference , 2xT-legs with solid 70cm foot, table height 73cm VX Conference , 2xT-legs with solid 70cm foot, table height 90cm VX Conference 2xT-legs electrical 73-110cm				912 940 1 564			
VX Project , 4xlegs, steel frame, table height 73cm VX Project , 4xlegs, steel frame, table height 90cm Upcharge for wooden legs with round profile				1 407 1 559	1 568 1 720	1 407 1 559 95	
VX Conference		VX Project					
							
Sizes: Length 2000-2400 mm Width 900-1200 mm		Sizes: Length 2000-2400 mm Width 1200 mm					

MEETING TABLES

MF+

Meeting tables within size 2400x1400 mm.

VX Conference is delivered with solid steel foot 900 mm. Wiring through the leg possible.

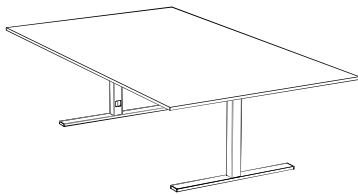
VX Project Stand is delivered with slanted legs in wood or metal.

When ordering, state the desired table size, profile, material and colour and height of the stand.

Table top (excluding legs)	White direct lam.	White laminate (HPL)	Optional laminate (HPL)	Linoleum	Veneer group 1	Veneer group 2
Series: Radius: Edge profile:						
VX (3416) * 0 mm Straight / matching list	743	1 188		1 451	1 689	1 689
VX (3417) * 0 mm Chamfered / matching list	780	1 225		1 488	1 737	1 737
VX (3418) * 50 mm Straight / matching list	782	1 251		1 528	1 780	1 780
Fri (3513) 30 mm Chamfered / MDF	821	1 290		1 567	1 829	1 829
* Upcharge for veneer edging on laminate		107				
* Upcharge for veneer edging on linoleum. Note: Only oak/ash nature and white pigmented. Not possible on stained tables.				107		

Stand (excluding table top):	White (31) Black (37)	Optional colours	Oak (03) Ash (06)	Stain / White pigm..
VX Conference , 2xT-legs with solid 90cm foot, table height 73cm	1 810			
VX Conference , 2xT-legs with solid 90cm foot, table height 90cm	1 914			
VX Conference 2xT-legs electrical 70-106cm	3 658			
VX Project , 4xlegs, steel frame, table height 73cm	1 407	1 568	1 407	1 488
VX Project , 4xlegs, steel frame, table height 90cm	1 559	1 720	1 559	1 640
Upcharge for wooden legs with round profile			95	95

VX Conference

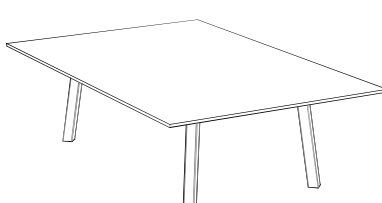


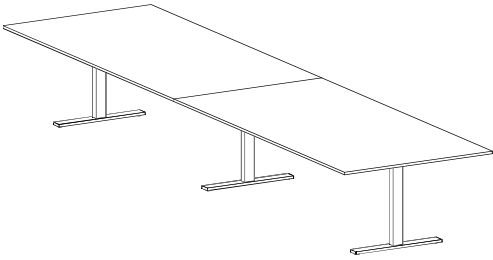
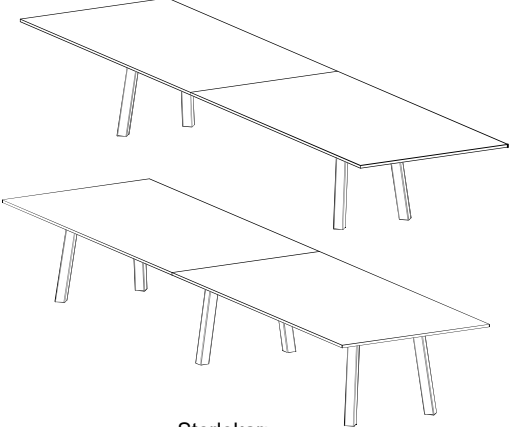
Sizes:
Length 2000-2400 mm
Width 1300-1400 mm

VX Project



Sizes:
Length 2000-2400 mm
Width 1300-1400 mm

MEETING TABLES							
<h1>MF++</h1> Meeting tables within size 2400x1600 mm.							
VX Project Stand is delivered with slanted legs in wood or metal. When ordering, state the desired table size, profile, material and colour and height of the stand.							
Table top (excluding legs)	White direct lam.	White laminate (HPL)	Optional laminate (HPL)	Linoleum	Veneer group 1	Veneer group 2	
Series: VX (3416) * Radius: 0 mm Edge profile: Straight / matching list * Upcharge for veneer edging on laminate * Upcharge for veneer edging on linoleum. Note: Only oak/ash nature and white pigmented. Not possible on stained tables.	1 012	1 568 107		1 973 107	1 883	1 883	
Stand (excluding table top):				White (31) Black (37)	Optional colours	Oak (03) Ash (06)	Stain / White pigm..
VX Project , 4xlegs, steel frame, table height 73cm VX Project , 4xlegs, steel frame, table height 90cm Upcharge for wooden legs with round profile				1 407 1 559	1 568 1 720	1 407 1 559 95	1 488 1 640 95
<p>VX Project</p>  <p>Sizes: Length 2000-2400 mm Width 1500-1600 mm</p>							

MEETING TABLES						
<h1>MG</h1> <p>2-piece Meeting tables within size 4800x1200</p> <p>VX T-legs are delivered with solid steel foot 700 mm. VX Project Stand is delivered with slanted legs in wood or metal. When ordering, state the desired table size, profile, material and colour and height of the stand.</p>						
Table top (excluding legs)	White direct lam.	White laminate (HPL)	Optional laminate (HPL)	Linoleum	Veneer group 1	Veneer group 2
Series: Radius: Edge profile: VX (3416) * 0 mm Straight / matching list, 2 pcs VX (3417) * 0 mm Chamfered / matching list, 2 pcs VX (3418) * 50 mm Straight / matching list, 2 pcs Fri (3513) 30 mm Chamfered / MDF, 2 pcs	1 474	1 546	1 603	2 409	1 765	1 765
	1 548	1 621	1 677	2 484	1 861	1 861
	1 552	1 628	1 687	2 536	1 858	1 858
	1 630	1 706	1 765	2 614	1 959	1 959
* Upcharge for veneer edging on laminate		215	215			
* Upcharge for veneer edging on linoleum. Note: Only oak/ash nature and white pigmented. Not possible on stained tables.				215		
Stand (excluding table top):			White (31) Black (37)	Optional colours	Oak (03) Ash (06)	Stain / White pigm..
VX Conference, 3xT-legs with solid 70cm foot, table height 73cm			1 557			
VX Conference, 3xT-legs with solid 70cm foot, table height 90cm			1 600			
VX Project, 4xlegs, aluminium frame, table height 73cm			2 523	2 684	2 523	2 604
VX Project, 4xlegs, aluminium frame, table height 90cm			2 675	2 836	2 675	2 756
Upcharge for wooden legs with round profile					95	95
VX Projekt, 6xlegs steel frame, table height 73cm			2 366	2 607	2 366	2 486
VX Projekt, 6xlegs steel frame, table height 90cm			2 591	2 832	2 591	2 712
Upcharge for wooden legs with round profile					142	142
<p>VX Conference</p>  <p>Storlekar: Length max 4800 mm Width 900-1200 mm</p>		<p>VX Project</p>  <p>Storlekar: Length max 4800 mm Width 1200 mm</p>				

MEETING TABLES

MG+

2-piece Meeting tables within size 4800x1400

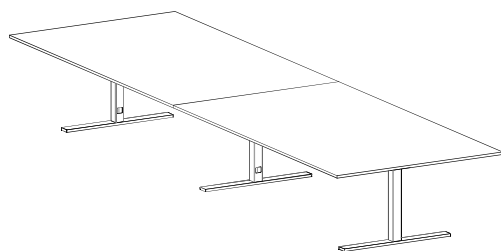
VX T-legs are delivered with solid steel foot 700 mm.

VX Project Stand is delivered with slanted legs in wood or metal.

When ordering, state the desired table size, profile, material and colour and height of the stand.

Table top (excluding legs)			White direct lam.	White laminate (HPL)	Optional laminate (HPL)	Linoleum	Veneer group 1	Veneer group 2
Serie	Hörnradie	Kantprofil						
VX (3416) *	0 mm	Straight / matching list, 2 pcs	1 598	2 488		3 015	3 491	3 491
VX (3417) *	0 mm	Chamfered / matching list, 2 pcs	1 672	2 562		3 089	3 586	3 586
VX (3418) *	50 mm	Straight / matching list, 2 pcs	1 682	2 619		3 174	3 694	3 694
Fri (3513)	30 mm	Chamfered / MDF, 2 pcs	1 761	2 697		3 251	3 775	3 775
* Upcharge for veneer edging on laminate				215				
* Upcharge for veneer edging on linoleum. Note: Only oak/ash nature and white pigmented. Not possible on stained tables.						215		
Stand (excluding table top):					White (31) Black (37)	Optional colours	Oak (03) Ash (06)	Stain / White pigm..
VX Conference , 3xT-legs with solid 70cm foot, table height 73cm					2 970			
VX Conference , 3xT-legs with solid 70cm foot, table height 90cm					3 127			
VX Project , 4xlegs, aluminium frame, table height 73cm					2 523	2 684	2 523	2 604
VX Project , 4xlegs, aluminium frame, table height 90cm					2 675	2 836	2 675	2 756
Upcharge for wooden legs with round profile							95	95
VX Projekt , 6xlegs steel frame, table height 73cm					2 366	2 607	2 366	2 486
VX Projekt , 6xlegs steel frame, table height 90cm					2 591	2 832	2 591	2 712
Upcharge for wooden legs with round profile							142	142

VX Conference



Sizes:
Length max 4800 mm
Width 1300-1400 mm

VX Project



Sizes:
Length max 4800 mm
Width 1300-1400 mm

MEETING TABLES

MG++ 2-piece Meeting tables within size 4800x1600

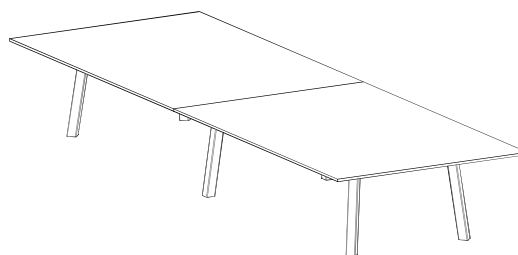
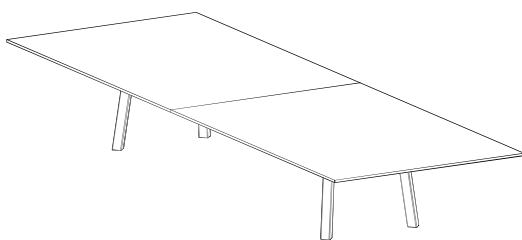
VX Project Stand is delivered with slanted legs in wood or metal.

When ordering, state the desired table size, profile, material and colour and height of the stand..

Table top (excluding legs)	White direct lam.	White laminate (HPL)	Optional laminate (HPL)	Linoleum	Veneer group 1	Veneer group 2
Series: Radius: Edge profile: VX (3416) * 0 mm Straight / matching list, 2 pcs * Upcharge for veneer edging on laminate * Upcharge for veneer edging on linoleum. Note: Only oak/ash nature and white pigmented. Not possible on stained tables.	2 135	3 260 215		4 069 215	3 878	3 878

Stand (excluding table top):	White (31) Black (37)	Optional colours	Oak (03) Ash (06)	Stain / White pigm..
VX Projekt , 4xlegs, aluminium frame, table height 73cm	2 523	2 684	2 523	2 604
VX Projekt , 4xlegs, aluminium frame, table height 90cm	2 675	2 836	2 675	2 756
Upcharge for wooden legs with round profile			95	95
VX Projekt , 6xlegs steel frame, table height 73cm	2 366	2 607	2 366	2 486
VX Projekt , 6xlegs steel frame, table height 90cm	2 591	2 832	2 591	2 712
Upcharge for wooden legs with round profile			142	142

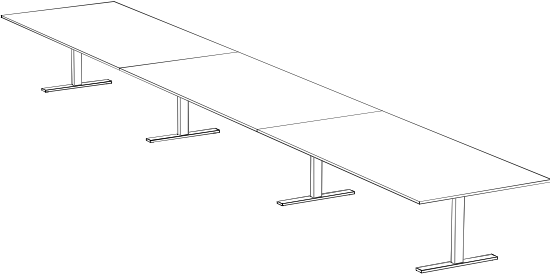
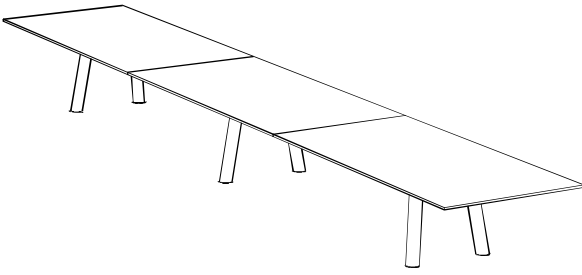
VX Project



Sizes:

Length max 4800 mm

Width 1500-1600 mm

MEETING TABLES																										
<h1>MH</h1> <p>3-piece Meeting tables within size 7200x1200</p> <p>VX T-legs are delivered with solid steel foot 700 mm. VX Project Stand is delivered with slanted legs in wood or metal. When ordering, state the desired table size, profile, material and colour and height of the stand.</p>																										
Table top (excluding legs)	White direct lam.	White laminate (HPL)	Optional laminate (HPL)	Linoleum	Veneer group 1	Veneer group 2																				
Series: Radius: Edge profile: VX (3416) * 0 mm Straight / matching list, 3 pcs VX (3417) * 0 mm Chamfered / matching list, 3 pcs VX (3418) * 50 mm Straight / matching list, 3 pcs Fri (3513) 30 mm Chamfered / MDF, 3 pcs	2 210	2 320	2 404	3 614	2 648	2 648																				
	2 322	2 431	2 515	3 726	2 791	2 791																				
	2 327	2 442	2 530	3 804	2 787	2 787																				
	2 445	2 559	2 648	3 922	2 938	2 938																				
* Upcharge for veneer edging on laminate		322	322																							
* Upcharge for veneer edging on linoleum. Note: Only oak/ash nature and white pigmented. Not possible on stained tables.				322																						
<table border="1"> <thead> <tr> <th>Stand (excluding table top):</th> <th>White (31) Black (37)</th> <th>Optional colours</th> <th>Oak (03) Ash (06)</th> <th>Stain / White pigm..</th> </tr> </thead> <tbody> <tr> <td>VX Conference, 4xT-legs with solid 70cm foot, table height 73cm</td> <td>2 188</td> <td></td> <td></td> <td></td> </tr> <tr> <td>VX Project, 6xlegs, aluminum frame, table height 73cm</td> <td>3 637</td> <td>3 878</td> <td>3 637</td> <td>3 757</td> </tr> <tr> <td>Upcharge for wooden legs with round profile</td> <td></td> <td></td> <td>142</td> <td>142</td> </tr> </tbody> </table>							Stand (excluding table top):	White (31) Black (37)	Optional colours	Oak (03) Ash (06)	Stain / White pigm..	VX Conference , 4xT-legs with solid 70cm foot, table height 73cm	2 188				VX Project , 6xlegs, aluminum frame, table height 73cm	3 637	3 878	3 637	3 757	Upcharge for wooden legs with round profile			142	142
Stand (excluding table top):	White (31) Black (37)	Optional colours	Oak (03) Ash (06)	Stain / White pigm..																						
VX Conference , 4xT-legs with solid 70cm foot, table height 73cm	2 188																									
VX Project , 6xlegs, aluminum frame, table height 73cm	3 637	3 878	3 637	3 757																						
Upcharge for wooden legs with round profile			142	142																						
<div style="display: flex; justify-content: space-around;"> <div style="text-align: center;"> <p>VX Conference</p>  <p>Sizes: Length max 7200 mm Width 1000-1200 mm</p> </div> <div style="text-align: center;"> <p>VX Project</p>  <p>Sizes: Length max 7200 mm Width 1200 mm</p> </div> </div>																										

MEETING TABLES

MH+

3-piece Meeting tables within size 7200x1400

VX Conference is delivered with solid steel foot 900 mm. Wiring through the leg possible.

VX Project Stand is delivered with slanted legs in wood or metal.

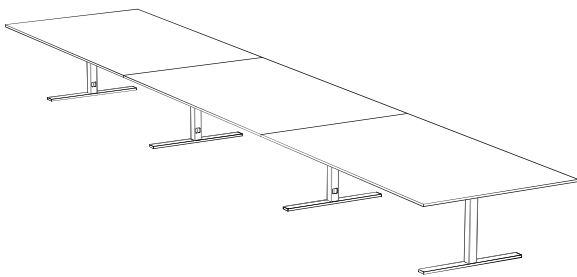
When ordering, state the desired table size, profile, material and colour and height of the stand.

Vid beställning ange önskad bordsstorlek, profil, material samt serie, färg och höjd på stativet.

Table top (excluding legs)	White direct lam.	White laminate (HPL)	Optional laminate (HPL)	Linoleum	Veneer group 1	Veneer group 2
Series: Radius: Edge profile:						
VX (3416) * 0 mm Straight / matching list, 3 pcs	2 397	3 732		4 522	5 236	5 236
VX (3417) * 0 mm Chamfered / matching list, 3 pcs	2 508	3 843		4 633	5 380	5 380
VX (3418) * 50 mm Straight / matching list, 3 pcs	2 524	3 928		4 760	5 521	5 521
Fri (3513) 30 mm Chamfered / MDF, 3 pcs	2 641	4 046		4 877	5 663	5 663
* Upcharge for veneer edging on laminate		322				
* Upcharge for veneer edging on linoleum. Note: Only oak/ash nature and white pigmented. Not possible on stained tables.				322		

Stand (excluding table top):	White (31) Black (37)	Optional colours	Oak (03) Ash (06)	Stain / White pigm..
VX Conference , 4xT-legs with solid 90cm foot, table height 73cm	4 130			
VX Project , 6xlegs, aluminum frame, table height 73cm	3 637	3 878	3 637	3 757
Upcharge for wooden legs with round profile			142	142

VX Conference

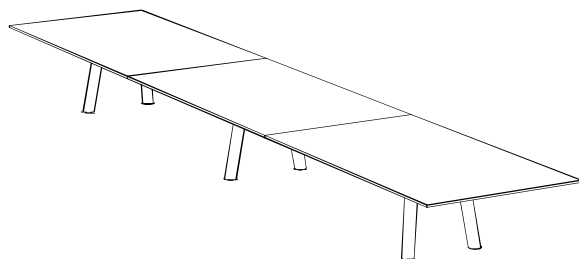


Sizes:

Length max 7200 mm

Width 1300-1400 mm

VX Project



Sizes:

Length max 7200 mm

Width 1300-1400 mm

MEETING TABLES

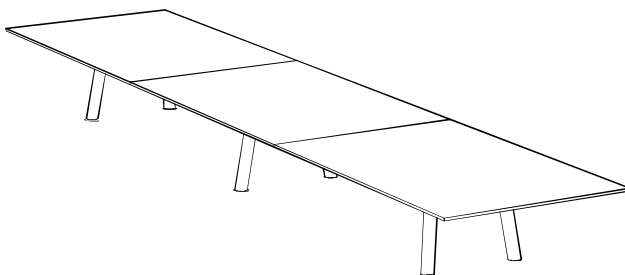
MH++ 3-piece Meeting tables within size 7200x1600

VX Project Stand is delivered with slanted legs in wood or metal.

When ordering, state the desired table size, profile, material and colour and height of the stand.

Table top (excluding legs)	White direct lam.	White laminate (HPL)	Optional laminate (HPL)	Linoleum	Veneer group 1	Veneer group 2	
Series: Radius: Edge profile: VX (3416) * 0 mm Straight / matching list, 3 pcs	3 258	4 951		6 165	5 873	5 873	
* Upcharge for veneer edging on laminate		322					
* Upcharge for veneer edging on linoleum. Note: Only oak/ash nature and white pigmented. Not possible on stained tables.				322			
Stand (excluding table top):				White (31) Black (37)	Optional colours	Oak (03) Ash (06)	Stain / White pigm..
VX Project , 6xlegs, aluminum frame, desk height 73cm				3 637	3 878	3 637	3 757
Upcharge for wooden legs with round profile						142	142

VX Project



Sizes:
Length max 7200 mm
Width 1500-1600 mm

MEETING TABLES

R1 Round meeting tables max diameter 1400

VX Project Stand is delivered with slanted legs in wood or metal.

When ordering, state the desired table size, profile, material and colour and height of the stand.

Series	Radius	Edge profile	White dir. laminate (31D)	White HPL (31)	Optional HPL (39)	Linoleum (88)	Veneer group 1	Veneer group 2
Round table tops ø 1000 - 1200 mm (excluding legs)								
VX (3416) *	0 mm	Straight / matching list	458	482	590	682	545	545
VX (3417) *	0 mm	Chamfered / matching list	567	597	705	797	660	660
Fri (3513)	30 mm	Chamfered / MDF	627	660	808	935	746	746

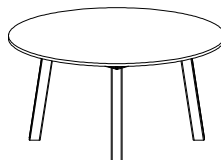
Round table top ø 1400 mm (excluding legs)								
VX (3416) *	0 mm	Straight / matching list	743	1 188		1 451	1 689	1 689
VX (3417) *	0 mm	Chamfered / matching list	780	1 225		1 488	1 737	1 737
Fri (3513)	30 mm	Chamfered / MDF	821	1 290		1 567	1 829	1 829

Option: cable lid 980

* Upcharge for veneer edging on laminate

* Upcharge for veneer edging on linoleum. Note: Only oak/ash nature and white pigmented. Not possible on stained tables.

VX Project 4xlegs with steel frame:	White (31) Black (37)	Optional colours	Oak (03) Ash (06)	Stain / White pigm..
Desk height 730 mm	1 407	1 568	1 407	1 488
Desk height 900 mm	1 559	1 720	1 559	1 640
Upcharge for wooden legs with round profile			95	95



Sizes (mm):
Ø 1000, 1200, 1400.

MEETING TABLES

R2

2-piece meeting tables max 2400x2400 mm

VX Project Stand is delivered with slanted legs in wood or metal.

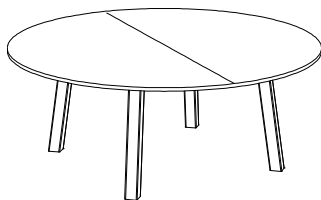
When ordering, state the desired table size, profile, material and colour and height of the stand.

No matching of veneer.

Round/square able tops ø 1500 - 2400 mm (excluding legs)			White dir. laminate (31D)	White HPL (31)	Optional HPL (39)	Linoleum (88)	Veneer group 1	Veneer group 2
Serie	Hörnradie	Kantprofil						
VX (3416)	0 mm	Rak med matchande kantlist, 2 st	1 474	1 546	1 603	2 409	1 765	1 765
VX (3417)	0 mm	Fasad med matchande kantlist, 2 st	1 548	1 621	1 677	2 484	1 861	1 861
Fri (3513)	30 mm	Fasad MDF, 2 st	1 630	1 706	1 765	2 614	1 959	1 959
* Upcharge for veneer edging on laminate				215	215			
* Upcharge for veneer edging on linoleum. Note: Only oak/ash nature and white pigmented. Not possible on stained tables.						215		
Option: cable lid 980								

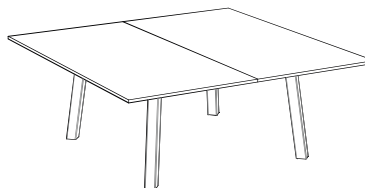
VX Project 4xlegs with steel frame (exck tabke top):	White (31) Black (37)	Optional colours	Oak (03) Ash (06)	Stain / White pigm..
Table height 73 cm	1 407	1 568	1 407	1 488
Table height 90 cm	1 559	1 720	1 559	1 640
Upcharge for wooden legs with round profile			95	95

VX Project round table tops



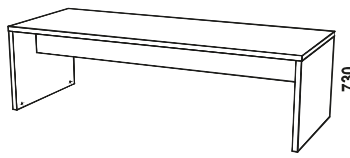

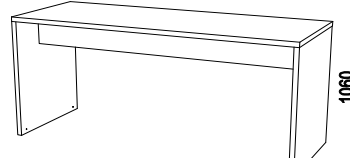


Sizes (mm):
Ø 1500, 1600, 1800, 2000, 2400.

VX Project square table tops



Sizes (mm):
1500X1500, 1600x1600, 1800x1800, 2000x2000, 2400x2400.

Illustration	Description	Article number	Material	EUR																				
<p>Nomono Conference Design: Fredrik Mattson</p>																								
	<p>Nomono CONFERENCE TABLE</p> <ul style="list-style-type: none"> Nomono conference is made of 38 mm particle board Radius 90 and straight edges with matching pp-list Material: <table border="0" data-bbox="542 392 1141 526"> <tr> <td>White lam. (31)</td> <td>Vitpigm.ek (30)</td> <td>Burgundy ash (C8)</td> </tr> <tr> <td>Oak (03)</td> <td>White ash (10)</td> <td>Conifer ash (D3)</td> </tr> <tr> <td>Ash (06)</td> <td>Black ash (86)</td> <td>Smokey Blue ash (D4)</td> </tr> <tr> <td></td> <td>Dark ash (76)</td> <td>Olive ash (D6)</td> </tr> <tr> <td></td> <td></td> <td>Mushroom ash (D7)</td> </tr> </table> Available in 3 heights. Distance from edge of desk to middle frame: <table border="0" data-bbox="542 571 1013 660"> <tr> <td>Width 1100 = 450 mm</td> <td>Width 800 = 300 mm</td> </tr> <tr> <td>Width 1000 = 400 mm</td> <td>Width 700 = 250 mm</td> </tr> <tr> <td>Width 900 = 350 mm</td> <td></td> </tr> </table> Cable box Bibox and Powerdot PM62 fit Nomono Conference. For more product information, please see www.horreds.se 	White lam. (31)	Vitpigm.ek (30)	Burgundy ash (C8)	Oak (03)	White ash (10)	Conifer ash (D3)	Ash (06)	Black ash (86)	Smokey Blue ash (D4)		Dark ash (76)	Olive ash (D6)			Mushroom ash (D7)	Width 1100 = 450 mm	Width 800 = 300 mm	Width 1000 = 400 mm	Width 700 = 250 mm	Width 900 = 350 mm			
White lam. (31)	Vitpigm.ek (30)	Burgundy ash (C8)																						
Oak (03)	White ash (10)	Conifer ash (D3)																						
Ash (06)	Black ash (86)	Smokey Blue ash (D4)																						
	Dark ash (76)	Olive ash (D6)																						
		Mushroom ash (D7)																						
Width 1100 = 450 mm	Width 800 = 300 mm																							
Width 1000 = 400 mm	Width 700 = 250 mm																							
Width 900 = 350 mm																								
	<p>Nomono conference in height 720 mm Available lengths: 2400, 2200, 2000, 1800 och 1600 mm.</p> <p>Width 800 or 900 mm</p> <p>Width 1000 or 1100 mm</p>		<table border="0"> <tr><td>White lam. (HPL)</td><td>2 190</td></tr> <tr><td>Oak / Ash</td><td>2 724</td></tr> <tr><td>Stained Ash</td><td>2 724</td></tr> <tr><td>White Oak / Ash</td><td>2 724</td></tr> <tr><td>White lam. (HPL)</td><td>2 369</td></tr> <tr><td>Oak / Ash</td><td>3 044</td></tr> <tr><td>Stained Ash</td><td>3 044</td></tr> <tr><td>White Oak / Ash</td><td>3 044</td></tr> </table>	White lam. (HPL)	2 190	Oak / Ash	2 724	Stained Ash	2 724	White Oak / Ash	2 724	White lam. (HPL)	2 369	Oak / Ash	3 044	Stained Ash	3 044	White Oak / Ash	3 044					
White lam. (HPL)	2 190																							
Oak / Ash	2 724																							
Stained Ash	2 724																							
White Oak / Ash	2 724																							
White lam. (HPL)	2 369																							
Oak / Ash	3 044																							
Stained Ash	3 044																							
White Oak / Ash	3 044																							
	<p>Nomono conference in height 900 mm Available lengths: 2400, 2200, 2000, 1800 och 1600 mm.</p> <p>Width 700, 800 or 900 mm</p> <p>Width 1000 or 1100 mm</p>		<table border="0"> <tr><td>White lam. (HPL)</td><td>2 190</td></tr> <tr><td>Oak / Ash</td><td>2 724</td></tr> <tr><td>Stained Ash</td><td>2 724</td></tr> <tr><td>White Oak / Ash</td><td>2 724</td></tr> <tr><td>White lam. (HPL)</td><td>2 369</td></tr> <tr><td>Oak / Ash</td><td>3 044</td></tr> <tr><td>Stained Ash</td><td>3 044</td></tr> <tr><td>White Oak / Ash</td><td>3 044</td></tr> </table>	White lam. (HPL)	2 190	Oak / Ash	2 724	Stained Ash	2 724	White Oak / Ash	2 724	White lam. (HPL)	2 369	Oak / Ash	3 044	Stained Ash	3 044	White Oak / Ash	3 044					
White lam. (HPL)	2 190																							
Oak / Ash	2 724																							
Stained Ash	2 724																							
White Oak / Ash	2 724																							
White lam. (HPL)	2 369																							
Oak / Ash	3 044																							
Stained Ash	3 044																							
White Oak / Ash	3 044																							
	<p>Nomono conference in height 1060 mm Available lengths: 2400, 2200, 2000, 1800 och 1600 mm.</p> <p>Width 700, 800 or 900 mm</p> <p>Width 1000 or 1100 mm</p>		<table border="0"> <tr><td>White lam. (HPL)</td><td>2 190</td></tr> <tr><td>Oak / Ash</td><td>2 724</td></tr> <tr><td>Stained Ash</td><td>2 724</td></tr> <tr><td>White Oak / Ash</td><td>2 724</td></tr> <tr><td>White lam. (HPL)</td><td>2 369</td></tr> <tr><td>Oak / Ash</td><td>3 044</td></tr> <tr><td>Stained Ash</td><td>3 044</td></tr> <tr><td>White Oak / Ash</td><td>3 044</td></tr> </table>	White lam. (HPL)	2 190	Oak / Ash	2 724	Stained Ash	2 724	White Oak / Ash	2 724	White lam. (HPL)	2 369	Oak / Ash	3 044	Stained Ash	3 044	White Oak / Ash	3 044					
White lam. (HPL)	2 190																							
Oak / Ash	2 724																							
Stained Ash	2 724																							
White Oak / Ash	2 724																							
White lam. (HPL)	2 369																							
Oak / Ash	3 044																							
Stained Ash	3 044																							
White Oak / Ash	3 044																							

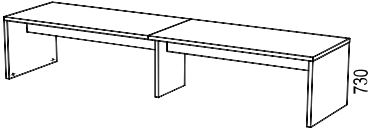
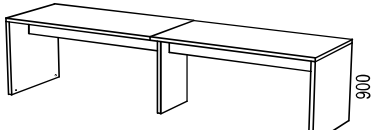
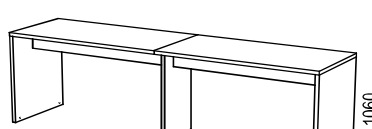
	<p>Nomono conference 2-piece tables in height 730 mm Lengths: 4800, 4400, 4000, 3600, 3200 and 2800 mm.</p> <p>Width 800 or 900 mm The centre panel is recessed.</p> <p>Width 1000 or 1100 mm The centre panel is recessed.</p>	<p>White lam. (HPL) 3 879 Oak / Ash 4 927 Stained Ash 4 927 White Oak / Ash 4 927</p> <p>White lam. (HPL) 4 228 Oak / Ash 5 556 Stained Ash 5 556 White Oak / Ash 5 556</p>	
	<p>Nomono conference 2-piece tables in height 900 mm Längder: 4800, 4400, 4000, 3600, 3200 and 2800 mm.</p> <p>Width 700, 800 or 900 mm The centre panel is recessed.</p> <p>Width 1000 or 1100 mm The centre panel is recessed.</p>	<p>White lam. (HPL) 3 879 Oak / Ash 4 927 Stained Ash 4 927 White Oak / Ash 4 927</p> <p>White lam. (HPL) 4 228 Oak / Ash 5 556 Stained Ash 5 556 White Oak / Ash 5 556</p>	
	<p>Nomono conference 2-piece tables in height 1060 mm Lengths: 4800, 4400, 4000, 3600, 3200 and 2800 mm.</p> <p>Width 700, 800 or 900 mm The centre panel is recessed.</p> <p>Width 1000 or 1100 mm The centre panel is recessed.</p>	<p>White lam. (HPL) 3 879 Oak / Ash 4 927 Stained Ash 4 927 White Oak / Ash 4 927</p> <p>White lam. (HPL) 4 228 Oak / Ash 5 556 Stained Ash 5 556 White Oak / Ash 5 556</p>	


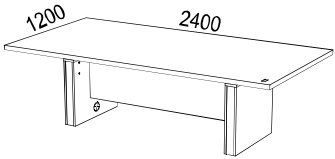
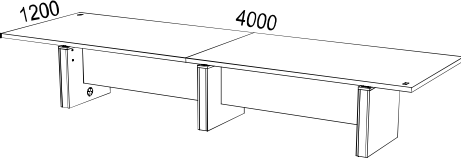
Illustration	Description	Material	EUR														
Nomono Meeting Design: Fredrik Mattson																	
	<p>Nomono Meeting Height-adjustable meeting table</p> <ul style="list-style-type: none"> Nomono Meeting is made of 38 mm particle board Radius 90 and straight edges with matching pp-list Material: <table border="0" data-bbox="619 465 1177 600"> <tr> <td>White lam. (31)</td> <td>Vitpigm.ek (30)</td> <td>Burgundy ash (C8)</td> </tr> <tr> <td>Oak (03)</td> <td>White ash (10)</td> <td>Conifer ash (D3)</td> </tr> <tr> <td>Ash (06)</td> <td>Black ash (86)</td> <td>Smokey Blue ash (D4)</td> </tr> <tr> <td></td> <td>Dark ash (76)</td> <td>Olive ash (D6)</td> </tr> <tr> <td></td> <td></td> <td>Mushroom ash (D7)</td> </tr> </table> Electrically adjustable stand 72-122 cm with following features: <ul style="list-style-type: none"> - 80mm/s lifting speed, - 800N lifting force/leg, - 0,1w standby power consumption - Free from PVC and PFAS. - 10 years warranty. Cable box Bibox and Powerdot PM62 fit Nomono Conference. For more product information, please see www.horreds.se 	White lam. (31)	Vitpigm.ek (30)	Burgundy ash (C8)	Oak (03)	White ash (10)	Conifer ash (D3)	Ash (06)	Black ash (86)	Smokey Blue ash (D4)		Dark ash (76)	Olive ash (D6)			Mushroom ash (D7)	
White lam. (31)	Vitpigm.ek (30)	Burgundy ash (C8)															
Oak (03)	White ash (10)	Conifer ash (D3)															
Ash (06)	Black ash (86)	Smokey Blue ash (D4)															
	Dark ash (76)	Olive ash (D6)															
		Mushroom ash (D7)															
	<p>Nomono Meeting tabletop 2400x1200 mm</p> <p>Nomono Meeting stand incl 2 leg boxes with electric legs, 1 desk panel and cable tray with cover</p> <p><i>Dimensions from end to short side of table: 401 mm</i> <i>Dimensions from leg box to long side of table: 270 mm</i></p>	<p>White lam.(HPL) 734 Veneer 978</p> <p>White lam.(HPL) 3 538 Veneer 4 178</p>															
	<p>Nomono Meeting 2-piece tabletop 4000x1200 mm</p> <p>Nomono Meeting stand incl 3 leg boxes with electric legs, 2 desk panels and 2 cable trays with cover</p> <p><i>Dimensions from end to short side of table: 451 mm</i> <i>Dimensions from leg box to long side of table: 270 mm</i></p>	<p>White lam.(HPL) 1 521 Veneer 2 010</p> <p>White lam.(HPL) 6 080 Veneer 7 134</p>															



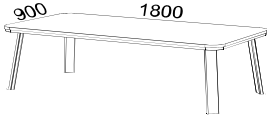
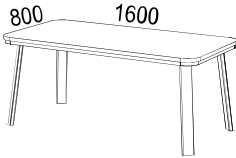
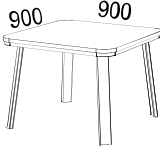
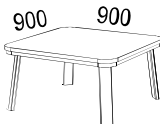
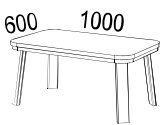
Illustration	Description	Article number	Material	EUR
Levels Design: Sami Kallio				
Levels MÖTESBORD / LOUNGE TABLE / COFFEE TABLE				
	<ul style="list-style-type: none"> • Tabletops in 28 mm MDF, corner radius 100 mm. • Veneered tables have matching edge strips. • Tables in white laminate and linoleum have matching edge strips alternatively veneered edge strip in clear lacquered oak or ash. • Legs in solid oak / ash. • For more product information, see www.horreds.se 			
	<p>Tabletop materials: <u>White high-pressure laminate</u> = closest to NCS S0502-Y <u>Linoleum:</u> 4132 Ash, 4154 Burgundy, 4166 Charcoal, 4172 Mauve, 4174 Conifer, 4175 Pebble, 4176 Mushroom, 4177 Vapour, 4179 Smokey Blue, 4184 Olive. <u>Veneer:</u> Oak (03) and Ash (06), Black stained sh (86), Dark stained ash (76), White pigment. ash (30), White pigment. ash (10), Burgundy ash (C8), Conifer ash (D3), Smokey Blue ash (D4), Olive ash (D6), Mushroom ash (D7).</p> <p>Stand material: <u>Solid Oak:</u> Oak clear lacquer (03), White pigment. Oak (30), <u>Solid Ash:</u> Ash clear lacquer (06), Black stained Ash (86), Dark stained ash (76), White pigmented ash (10), Burgundy stained ash (C8), Conifer stained ash (D3), Smokey Blue stained ash (D4), Olive stained ash (D6), Mushroom st.ash (D7).</p>			
Meeting table height 73 cm				
	Tabletop 180x90 cm	25 31 yy A002	White lam.(HPL)	698
		25 1x yy A002	Linoleum	698
		25 xx yy A002	Veneer	698
	Stand, height 73 cm	25 xx 18009073	Oak / ash	1 291
	Tabletop 160x80 cm	25 31 yy A003	White lam.(HPL)	610
		25 1x yy A003	Linoleum	610
		25 xx yy A003	Veneer	610
	Stand, height 73 cm	25 xx 16008073	Oak / ash	1 291
	Tabletop 90x90 cm	25 31 yy A004	White lam.(HPL)	473
		25 1x yy A004	Linoleum	473
		25 xx yy A004	Veneer	473
	Stand, height 73 cm	25 xx 09009073	Oak / ash	1 291
Lounge table / Coffe table height 50 cm				
	Tabletop 90x90 cm	25 31 yy A004	White lam.(HPL)	473
		25 1x yy A004	Linoleum	473
		25 xx yy A004	Veneer	473
	Stand, height 50 cm	25 xx 09009050	Oak / ash	1 149
	Tabletop 100x60 cm	25 31 yy A005	White lam.(HPL)	450
		25 1x yy A005	Linoleum	450
		25 xx yy A005	Veneer	450
	Stand, height 50 cm	25 xx 10006050	Oak / ash	1 149


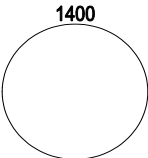
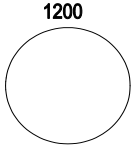
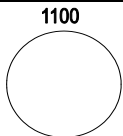
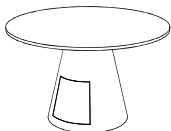

Illustration	Description	Article number	Material	EUR
<p>Tin Design: Morgan Rudberg och Lars Pettersson </p> <p>Tin CONFERENCE TABLE</p> <ul style="list-style-type: none"> • Desk tops in 19 mm MDF with matching list. • Rectangular table tops: radius 0. • Leg base of perforated, rolled steel sheet. White (31) or black (37). • Legs base with serice hatch for easy handling of cables. • Other RAL colours against quotation • Two desk heights: 73 and 90 cm. • Option: VX cable lid 06470 fits Tin. • For additional product information please see www.horreds.se <p>Material: White laminate (HPL) = closest NCS S0502-Y Optional laminate (HPL) : Light grey, Medium grey, Anthracite and Black Linoleum: 4132 Ash, 4154 Burgundy, 4166 Charcoal, 4172 Mauve, 4174 Conifer, 4175 Pebble, 4176 Mushroom, 4177 Vapour, 4179 Smokey Blue, 4184 Olive. Veneer group 1: Oak (03) and Ash (06) Veneer group 2: Black stained ash (86) / Dark stained ash (76), White pigm.oak(30), White pigm.ash (10) , Burgundy dash (C8), Conifer ash (D3), Smokey Blue ask (D4), Olive ash (D6), Mushroom ash (D7).</p>				
Round tabletops:				
 <p>1400</p>	Tabletop diameter 1400 mm, excluding stand and cable lid	47 31 1603174 47 39 1603174 47 88 1603174 47 xx 1603174 47 xx 1603174	White lam (HPL) Optional lam (HPL) Linoleum Veneer gr 1 Veneer gr 2	1 247 1 524 1 774 1 774
 <p>1200</p>	Tabletop diameter 1200 mm, excluding stand and cable lid	47 31 1603175 47 39 1603175 47 88 1603175 47 xx 1603175 47 xx 1603175	White lam (HPL) Optional lam (HPL) Linoleum Veneer gr 1 Veneer gr 2	506 620 716 572 572
 <p>1100</p>	Tabletop diameter 1100 mm, excluding stand and cable lid	47 31 1603300 47 39 1603300 47 88 1603300 47 xx 1603300 47 xx 1603300	White lam (HPL) Optional lam (HPL) Linoleum Veneer gr 1 Veneer gr 2	506 620 716 572 572
Stands for round tops (excl table top):				
	Tin stand with hatch.. Fits round table top (order separately) Desk heigh 73 cm Like above but desk height 90 cm	47 xx 73R-1 47 xx 90R-1	White / black White / black	2 874 2 994
	Tin stand without hatch.. Fits round table top (order separately) Desk heigh 73 cm Like above but desk height 90 cm	47 xx 73R 47 xx 90R	White / black White / black	2 553 2 674

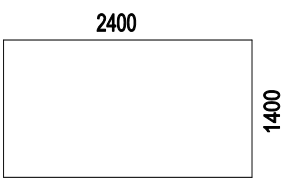

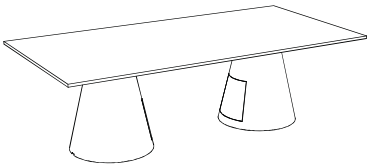
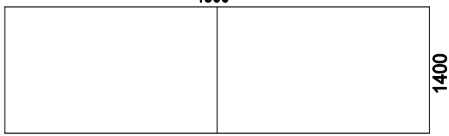
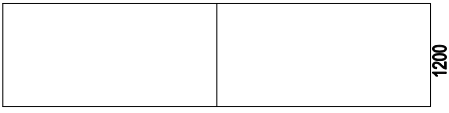
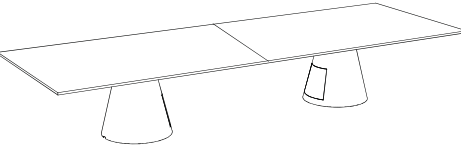
Illustration	Description	Article number	Material	EUR
Rectangular tabletops:				
	Tabletop 2400x1400 mm excluding stand and cable lid	47 31 16007713	White lam (HPL)	1 247
		47 39 16007713	Optional lam (HPL)	
		47 88 16007713	Linoleum	1 524
		47 xx 16007713	Veneer gr 1	1 774
		47 xx 16007713	Veneer gr 2	1 774
	Tabletop 2400x1200 mm excluding stand and cable lid	47 31 1603439	White lam (HPL)	753
		47 39 1603439	Optional lam (HPL)	812
		47 88 1603439	Linoleum	1 206
		47 xx 1603439	Veneer gr 1	868
		47 xx 1603439	Veneer gr 2	868
Stand for rectangular tops:				
	Tin stand (x2) with hatches. Fits rectangular tops (order separately) Desk heigh 73 cm	47 xx 73LLDD-1	White / black	6 248
		47 xx 90LLDD-1	White / black	6 487
2-pieces rectangular tabletops:				
	Tabletop 4800x1400 (2 pieces) excluding stand and cable lid	47 31 16xxxxx	White lam (HPL)	2 612
		47 39 16xxxxx	Optional lam (HPL)	
		47 88 160xxxx	Linoleum	3 166
		47 xx 160xxxx	Veneer gr 1	3 665
		47 xx 160xxxx	Veneer gr 2	3 665
	Tabletop 4800x1200 (2 pieces) excluding stand and cable lid	47 31 1603440	White lam (HPL)	1 624
		47 39 1603440	Optional lam (HPL)	1 683
		47 88 1603440	Linoleum	2 530
		47 xx 1603440	Veneer gr 1	1 853
		47 xx 1603440	Veneer gr 2	1 853
Stand for 2-piece rectangular tops:				
	Tin stand (x2) with hatches. Fits 2-piece rectangular tops (order separately). Desk height 73 cm	47 xx 73LLDD-1	White / black	6 760
		47 xx 90LLDD-1	White / black	6 999

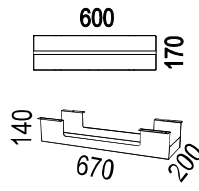
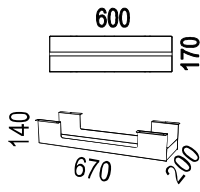

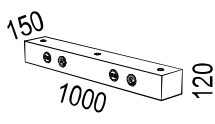
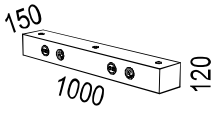
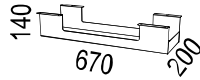
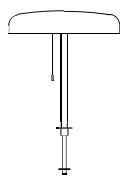
Illustration	Description	Article number	Material	EUR
CABLE SLOTS TO MEETING TABLES				
Cable entries and Hub suitable for: • VX Conference • VX Project				
Cable lid on hinges				
	Cable lid for conference table, chamfered edge, Length 600 mm. Incl. cable tray (white/black) Size of cable entry: 600x170 mm, with 2 flaps each 596x75 mm. <i>Not to tables in white direct laminate!</i>	34 31 04967 34 xx 04967 34 xx 04967	White lam. Optional lam. Linoleum	469 469 469
	Cable lid for conference table, chamfered edge, Length 600 mm. Incl. cable tray (white/black) Size of cable entry: 600x170 mm, with 2 flaps each 575x72 mm. Always produced in same material as the table top with matching of veneer.	35 xx 980x	Veneer	625
	Socket strip with 5 power, 2 data ports, 2 USB-C chargers, 1 USB-C port and 1 HDMI. Includes 2 m power cable.	93 5- T5UD20		419
	Power socket 3-ways, 3 m cable	93 6- E3V30B	Black	28
	Power socket 6-ways, 3 m cable	93 6- E6V30B	Black	33
	Hub • Screens for Hub, see page 115.			
	Hub in Forbo linoleum, with 4 x power (PM50) and 4 x USB -C charger (PM52). Prepared for lamps and Hub desk screens	34 xx 08350	Linoleum	1 134
	Hub in steel, with 4 x power (PM50) and 4 x USB -C charger (PM52). White (RAL9016) alt.black (RAL9005) structure. Prepared for lamps and Hub desk screens	34 31 09502 34 37 09502	White Black	1 039 1 039
	Cable tray conference 670x200x140 mm.	34 31 04381 34 37 04381	White Black	162 162
	Lampa Mushroom for mounting in HUB. Lamp for mounting in table top, including drilling Powder coated in black fine structure. Incl lightsource: LED E27 2700K 380lm CRI<80 (2pcs) Pull switch. Diameter 390mm, height 400 mm.	34 37 P380 34 37 P380B	Black Black	869 983 0 0 0


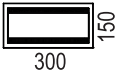



Illustration	Description	Article number	Material	EUR
Bibox (Also fits Nomono conference)				
	Bi-Box Large, openable cover and cable tray in one, including predrilling cost.	72 10 01-1	White	533
		72 10 01-2	Black	533
	Power Inlay for Bi-box Large: 4xPower, 4xNet and 4xUSB.data.	72 10 04		340
	Bi-Box Small, openable cover and cable tray in one, including predrilling cost.	72 10 00-1	White	294
		72 10 00-2	Black	294
	Power Inlay for Bi-box Small: 3xPower and 2xData.	72 10 02		149
Cable lid (Also fits Tin)				
	VX cable lid, diameter 260 mm. Incl cable tray (black or white) with PD10 power + magic hole), The cable lid is in same material as the table top	34 xxxx 06470		503
	Add.price for alternative powers: PD17 (1 power, 2 USB-C charger 2x30W)		add. / port	128
	PD13 (1 power, 1 USB-A port, 1 HDMI) Note: add prices are per each power.		add. / port	140
Powerdots (also fits Tin and Nomono conference)				
	Powerdot cable entry 80 mm 1 x el + 4 x Magic Holes	935 -PD10	Black	68
		935 -PD10W	White	68
	Powerdot cable entry 80 mm. 1 power, 2 USB-C charger (2x30W), 1 magic hole ø8 mm.	935 -PD17	Black	196
		935 -PD17W	White	196
	Powerdot cable entry 60 mm. 1 power, 1 USB-c charger 30w	935 -PM62	Black	149
		935 -PM62W	White	149
	Cable entry customised	HÄLT.2		124
	Kable sock ø 20mm in braided textile. Length 1500 mm. With zipper...	32 54 000109	Black	40
		32 54 000101	White	40
	Cable pipe in textile. Length1500 mm	29 37 1500	Black	122
		29 31 1500	White	122





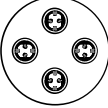



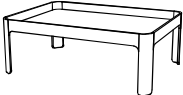
Illustration	Description	Article number	Material	EUR
	<p>MIT Design: Thomas Bernstrand och Stefan Borselius</p> <p>Accessories suitable for:</p> <ul style="list-style-type: none"> • VX Konferens • VX Projekt Konferens • Tin 			
	<p>Socket strip single with 4 x power (PM50) 348x108 mm</p>	<p>74 31 08179-4 74 37 08179-4</p>	<p>White Black</p>	<p>267 267</p>
	<p>Socket strip double with 4 x power (PM50) 188x188 mm</p>	<p>74 31 08182-4 74 37 08182-4</p>	<p>White Black</p>	<p>267 267</p>
	<p>Socket strip double with 6 x power (PM50) 268x188 mm</p>	<p>74 31 08182-6 74 37 08182-6</p>	<p>White Black</p>	<p>376 376</p>
	<p>Socket strip round with 4 x power (PM50) ø 245 mm</p>	<p>74 31 08208-4 74 37 08208-4</p>	<p>White Black</p>	<p>265 265</p>
	<p>Socket strip round with 6 x power (PM50) ø 245 mm</p>	<p>74 31 08208-6 74 37 08208-6</p>	<p>White Black</p>	<p>359 359</p>
	<p>Upcharge for alternative powerdot with double USB-C PD charger (PM52) Note: price for 1 piece only!</p>			<p>57</p>
	<p>Accessories tray for socket strip 08179-4 358x118x100 mm</p>	<p>74 31 08175-4 74 37 08175-4</p>	<p>White Black</p>	<p>561 561</p>
	<p>Accessory tray for socket strip 08124-4 198x198x100 mm</p>	<p>74 31 08180-4 74 37 08180-4</p>	<p>White Black</p>	<p>561 561</p>
	<p>Accessory tray for socket strip 08124-6 278x198x100 mm</p>	<p>74 31 08180-6 74 37 08180-6</p>	<p>White Black</p>	<p>635 635</p>


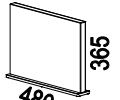
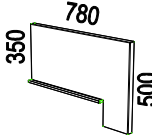
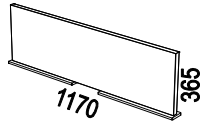
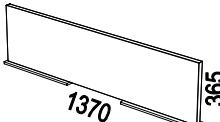

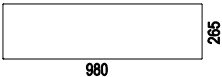
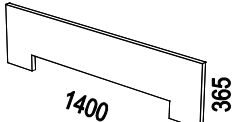
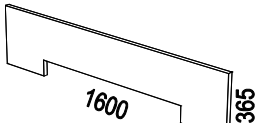


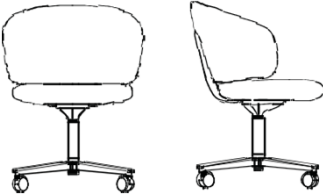
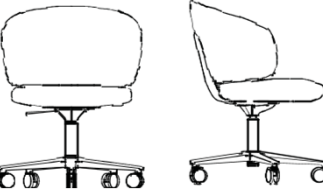
Illustration	Description	Article number	Material	EUR
<p>Screens</p> <ul style="list-style-type: none"> • Thickness 35 mm, of which 30 mm in sound absorbing material • For other fabrics; please ask for quotation. 				
<p>Price group 1: <u>Camira:</u> Cara, Carlow <u>Gabriel:</u> Event Screen, Hush</p>	<p>Price group 2: <u>Camira:</u> Blazer Lite <u>Gabriel:</u> Soul, Soul Mel, Twist, Twist Mel, Focus Melange Screen, Cura Screen <u>Kvadrat:</u> Hint Screen</p>	<p>Price group 3: <u>Camira:</u> Blazer, Main Line Flax <u>Gabriel:</u> Step Melange Screen <u>Kvadrat:</u> Remix, Remix Screen, Floyd Scr.</p>		
Free standing screens				
	<p>Sound absorbing side screen 480x365x35 mm with foot in wood (ø 250mm) Foot available in hard vaxed oiled oak and stained ash.</p>	34 xx 09147-x	PG 1 PG 2 PG 3	383 408 435
	<p>Sound absorbing side screen 480x365x35 mm Including foot in laquered steel. Choose colour of the foot; white or black.</p>	34 xx 03374-x	PG 1 PG 2 PG 3	301 320 348
	<p>Sound absorbing side screen 780x350x35 mm. Including foot in laquered steel. Choose colour of the foot; white or black.</p>	34 xx 06360-x	PG 1 PG 2 PG 3	373 410 447
	<p>Sound absorbing side screen 1170x365x35 mm Including foot in laquered steel. Choose colour of the foot; white or black.</p>	34 xx 04360-x	PG 1 PG 2 PG 3	566 607 662
	<p>Sound absorbing side screen 1370x365x35 mm Including foot in laquered steel. Choose colour of the foot; white or black.</p>	34 xx 04361-x	PG 1 PG 2 PG 3	583 628 685
	<p>Pen tray for side screen on foot.</p>	34 31 03357 34 37 03357	White Black	70 70
Screens for Hub				
	<p>Sound absorbing desk screen 980x265x35 mm, for mounting in Hub. Incl white or black fittings.</p>	34 xx 03375-x	PG 1 PG 2 PG 3	362 388 423
	<p>Sound absorbing desk screen 1400x365x35 mm, for mounting in Hub. Incl white or black fittings.</p>	34 xx 04358-x	PG 1 PG 2 PG 3	414 441 481
	<p>Sound absorbing desk screen 1600x365x35 mm, for mounting in Hub. Incl white or black fittings.</p>	34 xx 04359-x	PG 1 PG 2 PG 3	432 464 506

Illustration	Description	Article number	Price group	EUR
Prime Design: Fredrik Mattson				
<div style="display: flex; justify-content: space-between; align-items: flex-start;"> <div style="width: 25%;">  </div> <div style="width: 70%;"> <p>Prime CHAIR</p> <ul style="list-style-type: none"> • Fully upholstered conference or meeting chair. • Seat of molded HR foam on plywood, molded back with metal insert. • CMHR foam for an extra charge € 70 • 4-star aluminium stand with castors • 5-star aluminium stand with castors, height adjustable 43-55 cm. • 5-star aluminium stand with castors and adjustable footrest, height adjustable 60-80 cm. • Steel legs • Castors with polyurethane tread, suitable for all floors. • Price for leather chairs in quantities of less than 2; subject to quotation • For more product information see www.horreds.se <p>Kulörer stativ:: Stand colours:</p> <ul style="list-style-type: none"> • Black RAL 9005 (37) - standard. • Optional RAL*: at extra cost: 1019 Grey beige (3H), 1024 Ochre yellow (3G), 3007 Black red (3D), 5008 Grey blue (3C), 6009 Fir green (3L), 6013 Reed green (3K), 7039 Quartz grey (3J), 7044 Silk grey (3A) och Traffic white (31). <i>(not applicable to 30A)</i> • Polished top surface (13)* - at extra cost.. <i>(not applicable to 40A)</i> </div> <div style="width: 15%; text-align: right;">  </div> </div>				
 <p>Seat height: 46cm Width: 60cm Height: 82cm Depth: 57cm</p>	<p>4-wing black aluminium stand with castors. Fixed height, tilt, swivel, damping.</p> <p>*NB Leather: min quantity 2 pcs in same colour</p> <p><i>Upcharge optional colours (black castors+tilt)</i></p> <p><i>Upcharge polished stand (black details)</i></p> <p><i>Upcharge for interval braked castors</i></p>	<p>50 xx 20A-xxx</p> <p>50 yy 20A-xxx</p> <p>50 13 20A-xxx</p> <p>50 xx 22A-xxx</p>	<p>PG 1 PG 2 PG 3 PG 4 PG 5 PG 6 PG 7 Leather*</p>	<p>1 053 1 097 1 144 1 190 1 245 1 319 1 423 1 547</p> <p>80 30 28</p>
 <p>Sea height: 43-55cm Width: 60cm Height: 79-91cm Depth: 60 cm</p>	<p>5-wing black aluminium stand with castors. Height adjustable 43-55cm, tilt , swivel.</p> <p>*NB Leather: min quantity 2 pcs in same colour</p> <p><i>Upcharge optional colours (black castors+tilt)</i></p> <p><i>Upcharge polished stand (black details)</i></p> <p><i>Upcharge for interval braked castors</i></p>	<p>50 xx 10A-xxx</p> <p>50 yy 10A-xxx</p> <p>50 13 10A-xxx</p> <p>50 xx 12A-xxx</p>	<p>PG 1 PG 2 PG 3 PG 4 PG 5 PG 6 PG 7 Leather*</p>	<p>1 072 1 115 1 162 1 208 1 263 1 337 1 441 1 565</p> <p>80 30 28</p>

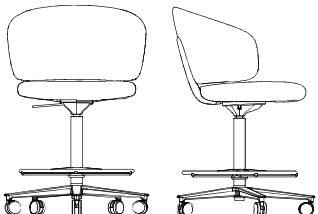
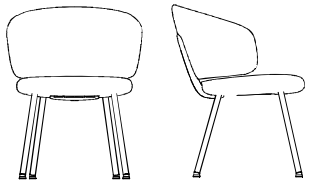
 <p>Seat height: 60-80cm Width: 60cm Height: 97-117cm Depth: 60cm</p>	<p>Prime High 5-wing black aluminium stand with castors. Height adjustable 60-80cm, tilt, swivel and interval braked castors. Adjustable footrest black/chrome</p> <p>*NB Leather: min quantity 2 pcs in same colour</p> <p><i>Upcharge polished stand (black details)</i></p>	<p>50 37 30A-xxx</p> <p>50 13 30A-xxx</p>	<p>PG 1 PG 2 PG 3 PG 4 PG 5 PG 6 PG 7 Leather*</p>	<p>1 255 1 298 1 345 1 391 1 446 1 520 1 624 1 748</p> <p>30</p>
 <p>Seat height: 46cm Width: 60cm Height: 82cm Depth: 57cm</p>	<p>Prime med 4 st stålben Svart RAL 9005 (37) alternativt tillvalskulörer</p> <p>*OBS Läder: minimum antal 2 st i samma kulör</p> <p><i>Tillägg för filttassar</i></p>	<p>50 xx 40A</p> <p>50 xx 40AF</p>	<p>PG 1 PG 2 PG 3 PG 4 PG 5 PG 6 PG 7 Leather*</p>	<p>892 936 982 1 029 1 084 1 158 1 262 1 386</p> <p>11</p>




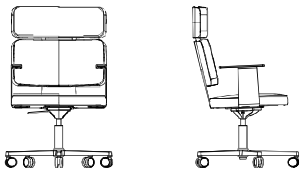
Illustration	Description	Article number	Price group	EUR
Grand Design: Thomas Bernstrand och Stefan Borselius				
	Grand CHAIR <ul style="list-style-type: none"> • Upholstered confence or meeting chair. • Seat of HR-foam on plywood, molded back with metal inserts. • Upcharge for CHMR-foam: € 62. • Arm rest in solid oak / ash or black leather. • Leather armchairs always have armrests in matching leather. • Can also be ordered without armrests. • 5-wing aluminum stand with castors. Powder coated (black and white). • 4-wing aluminum stand with or without castors. Powder coated (black and white). • Lounge model with foot plate and autoreturn. Powder coated (black and white). • Castors with polyurethane roller track, suitable for all floors. • Price for leather chairs in less than 2 pieces; against quotation. • For more product information, see www.horreds.com 			
	<u>Stands:</u> WhiteRAL 9016 (31) Black RAL 9005 (37)	<u>Armrests:</u> Oak (03), Ash (06), Black ash (86), Dark ash (76), White oak (30), White ash (10)		
5-WINGED WITH CASTORS <ul style="list-style-type: none"> • Seat height 44-49 cm • Height of low back 82-87 cm / high back 104-109 cm • Width 67 cm • Height armrests 63-69 cm • Depth 65 cm 				
	Chair with low back and armrests in solid oak / ash (nature/white pigm../dark stained). 5-wing stand, adjustable height 44-49 cm, tilt. Black (37) White (31)	71 xx xx 11M-xxx	PG 1 PG 2 PG 3 PG 4 PG 5 PG 6 PG 7 Leather*	1 349 1 386 1 428 1 471 1 518 1 570 1 645 1 724
	*Note:Leather minimum 2 pcs in same color, always matching leather on armrests	71 xx 97 11M-xxx		
	Upcharge armrests in black leather	71 xx BL 11M-xxx		43
	Upcharge for interval braked castors	71 xx xx 12M-xxx		28
	Deduction for chair without armrests	71 xx 00 11M-xxx		-119
	Chair with high back and armrests in solid oak / ash (nature/white pigm../dark stained). 5-wing stand, adjustable height 44-49 cm, tilt. Black (37) White (31)	71 xx xx 11H-xxx	PG 1 PG 2 PG 3 PG 4 PG 5 PG 6 PG 7 Leather*	1 549 1 596 1 649 1 702 1 761 1 827 1 920 2 030
	*Note:Leather minimum 2 pcs in same color, always matching leather on armrests	71 xx 97 11H-xxx		
	Upcharge armrests in black leather	71 xx BL 11H-xxx		43
	Upcharge for interval braked castors	71 xx xx 12H-xxx		28
	Deduction for chair without armrests	71 xx 00 11H-xxx		-119

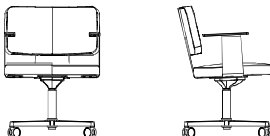
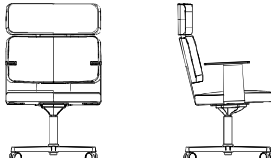
Illustration	Description	Article number	Price group	EUR
<p>4-WING WITH CASTORS</p> <ul style="list-style-type: none"> • Seat height 46 cm • Height of low back 84 cm / high back 106 cm • Width including armrest 60 cm / exclusive armrest 59 cm • Height armrest 67cm • Depth 59 cm 				
	Chair with low back and armrests in solid oak / ash (nature/white pigm../dark stained). 4-wing stand with castors, fixed height 46 cm. Tilt. Black (37) White (31)	71 xx xx 20M-xxx	PG 1 PG 2 PG 3 PG 4 PG 5 PG 6 PG 7	1 300 1 337 1 379 1 422 1 469 1 522 1 596
	Note:Leather minimum 2 pcs in same color, always matching leather on armrests	71 xx 97 20M-xxx	Leather	1 675
	Upcharge armrests in black leather	71 xx BL 20M-xxx		43
	Upcharge for interval braked castors	71 xx xx 22M-xxx		28
	Deduction for chair without armrests	71 xx 00 20M-xxx		-119
	Chair with high back and armrests in solid oak / ash (nature/white pigm../dark stained). 4-wing stand with castors, fixed height 46 cm. Tilt. Black (37) White (31)	71 xx xx 20H-xxx	PG 1 PG 2 PG 3 PG 4 PG 5 PG 6 PG 7	1 502 1 548 1 601 1 654 1 713 1 779 1 872
	Note:Leather minimum 2 pcs in same color, always matching leather on armrests	71 xx 97 20H-xxx	Leather	1 982
	Upcharge armrests in black leather	71 xx BL 20H-xxx		43
	Upcharge for interval braked castors	71 xx xx 22H-xxx		28
	Deduction for chair without armrests	71 xx 00 20H-xxx		-119

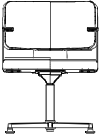
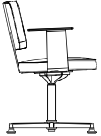
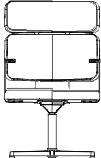

Illustration	Description	Article number	Price group	EUR
4-WING WITH GLIDES • Seat height 46 cm • Height of low back 84 cm / high back 106 cm • Width including armrest 60 cm / exclusive armrest 59 cm • Height armrest 67cm • Depth 59 cm				
 	Chair with low back and armrests in solid oak / ash (nature/white pigm../dark stained). 4-wing stand without castors, fixed height 46 cm. Tilt. Black (37) White (31) Glides are always black.	71 xx xx 21M-xxx	PG 1 PG 2 PG 3 PG 4 PG 5 PG 6 PG 7	1 270 1 308 1 350 1 393 1 440 1 492 1 567
	Note:Leather minimum 2 pcs in same color, always matching leather on armrests	71 xx 97 21M-xxx	Leather	1 646
	Upcharge armrests in black leather	71 xx BL 21M-xxx		43
	Deduction for chair without armrests	71 xx 00 21M-xxx		-119
 	Chair with high back and armrests in solid oak / ash (nature/white pigm../dark stained). 4-wing stand without castors, fixed height 46 cm. Tilt. Black (37) White (31) Glides are always black.	71 xx xx 21H-xxx	PG 1 PG 2 PG 3 PG 4 PG 5 PG 6 PG 7	1 472 1 519 1 572 1 625 1 684 1 749 1 843
	Note:Leather minimum 2 pcs in same color, always matching leather on armrests	71 xx 97 21H-xxx	Leather	1 952
	Upcharge armrests in black leather	71 xx BL 21H-xxx		43
	Deduction for chair without armrests	71 xx 00 21H-xxx		-119

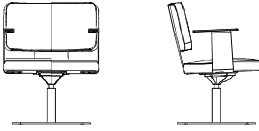
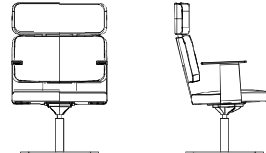

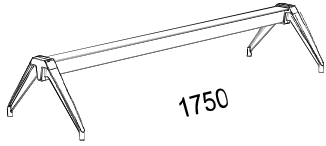
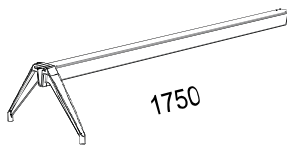
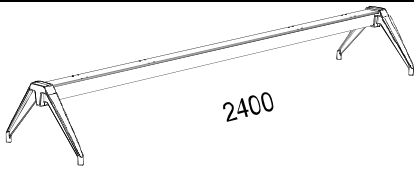
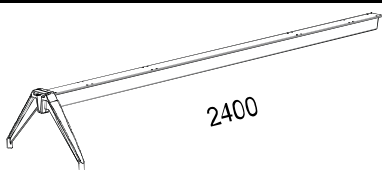
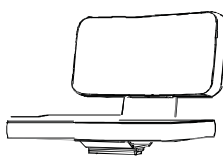


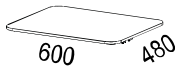
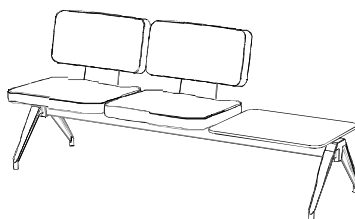
Illustration	Description	Article number	Price group	EUR
<p>LOUNGE CHAIR WITH FOOT PLATE</p> <ul style="list-style-type: none"> • Seat height 41 cm • Height of back 79 cm / high back 101 cm • Width including armrest 60 cm / exclusive armrest 59 cm • Height armrest 67cm • Depth 59 cm 				
	Chair with low back and armrests in solid oak / ash (nature/white pigm../dark stained). Lounge chair with foot plate, fixed height. tilt and autoreturn. Black (37) White (31)	71 xx xx 30M-xxx	PG 1 PG 2 PG 3 PG 4 PG 5 PG 6 PG 7	1 346 1 383 1 425 1 468 1 515 1 568 1 642
	Note:Leather minimum 2 pcs in same color, always matching leather on armrests	71 xx 97 30M-xxx	Leather	1 721
	Upcharge armrests in black leather	71 xx BL 30M-xxx		43
	Deduction for chair without armrests	71 xx 00 30M-xxx		-119
	Chair with high back and armrests in solid oak / ash (nature/white pigm../dark stained). Lounge chair with foot plate, fixed height. tilt and autoreturn. Black (37) White (31)	71 xx xx 30H-xxx	PG 1 PG 2 PG 3 PG 4 PG 5 PG 6 PG 7	1 547 1 594 1 647 1 700 1 759 1 825 1 918
	Note:Leather minimum 2 pcs in same color, always matching leather on armrests	71 xx 97 30H-xxx	Leather	2 028
	Upcharge armrests in black leather	71 xx BL 30H-xxx		43
	Deduction for chair without armrests	71 xx 00 30H-xxx		-119

Illustration	Description	Article number	Price group	EUR
Grand Balk Design: Thomas Bernstrand och Stefan Borselius				
	<p>GRAND BALK Sofa</p> <ul style="list-style-type: none"> Fully upholstered buildable beam sofa in seat height 46 cm. Beam and legs in recycled aluminum, powder coated. Seat module of molded HR raom on plywood, molded back with metal insert. CMHR foam for an additional € 62. Arms upport in solid oak / ash. Black leather for an additional € 43. Armchairs in leather always have leather-covered handles in same colour. For mor product information see www.horreds.se 			
	Beam, freestanding, for 3 modules Length 1750mm	71 37 1750	Black	1 074
	Beam, for coupling, for 3 modules Lengt 1750mm, with 1 leg. <i>To be used together with freestanding beam</i>	71 37 1750K	Black	952
	Beam, freestanding, for 4 modules Length 2400mm	71 37 2400	Black	1 252
	Beam, for coupling, for 4 modules Lengt 2400mm, with 1 leg. <i>To be used together with freestanding beam</i>	71 37 2400K	Black	1 129
	Seating module with black back plate. Incl. clamp to beam. • Width 59cm • Depth 59cm • Back height 82cm (above floorv) *NB:Leather minimum 2 pcs in same colour,	71 37 00M-x	PG 1 PG 2 PG 3 PG 4 PG 5 PG 6 PG 7 Leather*	812 853 894 935 982 1 045 1 139 1 218
	Upcharge for armsupport right / left Note: Price per piece Black bracket with armsupport in solid oak/ ash (clear coated or standard stains)	71 xx37 08129H 71 xx37 08129V	black/veneer black/veneer	60 60
	Table top 480x300mm, incl clamp, corresponds to 0,5 module. With edging and chamfered edge.	71 xx37 -300	Veneer Laminate Linoleum	212 212 212
	Table top 480x600mm, incl clamp, corresponds to 1 module. With edging and chamfered edge.	71 xx37 -600	Veneer Laminate Linoleum	366 366 366

	Electricity / charging in table top - required 2 pcs / table.				
	1 x Power	935	PM50	Black	65
	2x USB-C charger	935	PM52	Black	149
	Kabelstrumpa i textil 1500mm	29	37	1500	Black 122

Price example 1:



Freestanding beam for 3 modules
Seating module
Table top 480x600 mm, incl clamp

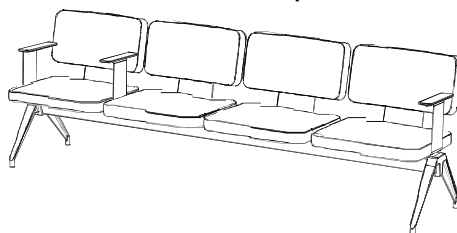
art nr 71 37 1750

art 71 37 00M-x

art 71 06 37-600

Material	Pieces	Price/pce	Total
Svart	1	1 074	1 074
Tyg PG 1	2	812	1 624
Ask	1	366	366
			3 064

Price example 2:



Freestanding beam for 4 modules
Seating module
Armrest right
Karmstöd vänster

art nr 71 37 2400

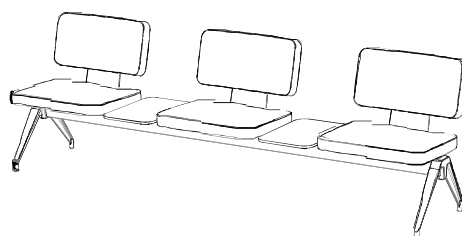
art 71 37 00M-x

art 71 37 06 08129H

art 71 37 06 08129V

Material	Pieces	Price/pce	Total
Black	1	1 252	1 252
PG 1	4	812	3 248
Black/ash	1	60	60
Black/ash	2	60	120
			4 500

Price example 3:



Freestanding beam for 4 modules
Seating module
Table top 480x300 mm, incl clamp

art nr 71 37 2400

art 71 37 00M-x

art 71 06 37-300

Material	Pieces	Price/pce	Total
Svart	1	1 252	1 252
Tyg PG 1	3	812	2 436
Ask	2	212	424
			4 112

Corner arrangements / other lengths; please contact us for a quote.

Glove Design: Fredrik Mattson**Glove Medium and High**

- Upholstered meeting chair in high or medium design. Choose between 6 different stands.
- Molded cold foam (HR) with metal frame. Upcharge for CMHR foam; € 37.
- Castors with polyurethane roller conveyor, suitable for all floors.
- Selected stands are available in optional colours, others on request.
- Optional colours RAL: 1019 Grey beige (3H), 1024 Ochre yellow (3G), 3007 Black red (3D), 5008 Grey blue (3C), 6009 Fir green (3L), 6013 Reed green (3K), 7039 Quartz grey (3J), 7044 Silk grey (3A) and Traffic white (31)
- For fabric selection; see Fabrics - Price Groups. If other fabric desired; contact us for a quote.
- Channel-sewn upholstery Bolster as an option in price group 1-7 excl. artificial leather.



5-wing aluminum stand with tilt. Adjustable height 43-53 cm.
Colours: black, polished and optional colour.s



4-wing aluminum stand with castors castors and tilt. Fixed height 46cm.
Colours: black, polished and optional colours.



4-wing aluminum stand with sliding feet and tilt. Fixed height 46cm.
Colours: black, polished and optional colours.



4-legged steel stand..
Colours: black, white and



Wooden legs in oak and. ash.
Optional stain: white, dark, black, Burgundy, Conifer, Smokey Blue, Olive och Mushroom.

NEW

Photo will soon follow!

Steel legs in black and optional colours.

Glove Bolster Cover

Do you have a Glove that needs to be renewed?
Glove Bolster Cover is a cover for Glove High and Medium.
The bolster cover not only gives Glove a new life, but also a new character.
A figure-hugging, looser and slightly more comfortable sitting experience.



- For more product information, see www.horreds.se


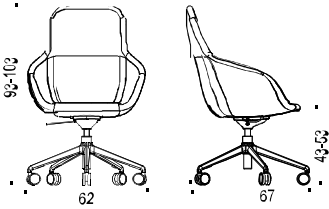
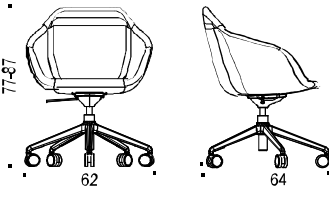
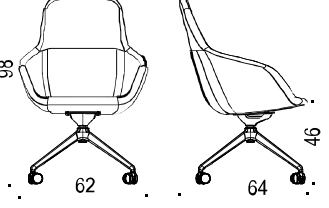
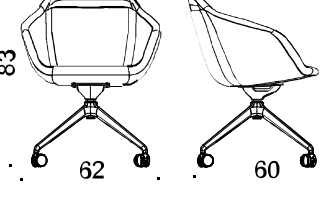
Illustration	Description	Article number	Price group	EUR
Glove Design: Fredrik Mattson				
Glove CHAIR				
	<p>Chair, high back. 5-wing aluminum base, with tilt, rotatable, adjustable height 43-53 cm. Black base (37).</p> <p>*NB: Leather min. 2 chairs in same colour <i>Upcharge for Bolster upholstery pg 1-7**</i> <i>Upcharge for interval braked castors</i> <i>Upcharge polished stand (black tilt)</i> <i>Upcharge for swing with adj. hardness</i> <i>Upcharge opt.colours stand (black castors/tilt)</i></p>	<p>51 37 51H01-xxx</p> <p>51 xx 51H0B-xxx</p> <p>51 xx 51HI1-xxx</p> <p>51 13 51H01-xxx</p> <p>51 xx 52H01-xxx</p> <p>51 yy 51H01-xxx</p>	<p>PG 1 PG 2 PG 3 PG 4 PG 5 PG 6 PG 7 Leather*</p>	<p>1 090 1 140 1 197 1 254 1 318 1 388 1 488 1 546 144 28 56 99 80</p>
	<p>Chair, medium back. 5-wing aluminum stand, with tilt, rotatable, adjustable height 43-53 cm. Black base (37).</p> <p>*NB: Leather min. 2 chairs in same colour <i>Upcharge for Bolster upholstery pg 1-7**</i> <i>Upcharge for interval braked castors</i> <i>Upcharge polished stand (black tilt)</i> <i>Upcharge for swing with adj. hardness</i> <i>Upcharge opt.colours stand (black castors/tilt)</i></p>	<p>51 37 51M01-xxx</p> <p>51 xx 51M0B-xxx</p> <p>51 xx 51MI1-xxx</p> <p>51 13 51M01-xxx</p> <p>51 xx 52M01-xxx</p> <p>51 yy 51M01-xxx</p>	<p>PG 1 PG 2 PG 3 PG 4 PG 5 PG 6 PG 7 Leather*</p>	<p>1 008 1 052 1 101 1 151 1 206 1 266 1 353 1 484 144 28 56 99 80</p>
	<p>Chair, high back. 4-winged aluminium base with castors and tilt, turnable. Black base (37).</p> <p>*NB: Leather min. 2 chairs in same colour <i>Upcharge for Bolster upholstery pg 1-7**</i> <i>Upcharge polished stand (black tilt)</i> <i>Upcharge opt.colours stand (black castors/tilt)</i></p>	<p>51 37 31H01-xxx</p> <p>51 xx 31H0B-xxx</p> <p>51 13 31H01-xxx</p> <p>51 yy 31H01-xxx</p>	<p>PG 1 PG 2 PG 3 PG 4 PG 5 PG 6 PG 7 Leather*</p>	<p>1 043 1 094 1 151 1 207 1 271 1 341 1 442 1 500 144 43 65</p>
	<p>Chair, medium back. 4-winged aluminium base with castors and tilt, turnable. Black base (37).</p> <p>*NB: Leather min. 2 chairs in same colour <i>Upcharge for Bolster upholstery pg 1-7**</i> <i>Upcharge polished stand (black tilt)</i> <i>Upcharge opt.colours stand (black castors/tilt)</i></p>	<p>51 37 31M01-xxx</p> <p>51 xx 31M0B-xxx</p> <p>51 13 31M01-xxx</p> <p>51 yy 31M01-xxx</p>	<p>PG 1 PG 2 PG 3 PG 4 PG 5 PG 6 PG 7 Leather*</p>	<p>962 1 005 1 055 1 104 1 159 1 220 1 307 1 437 144 43 65</p>

Illustration	Description	Article number	Price group	EUR
	<p>Chair, high back 4-winged aluminium base with glides and tilt, turnable. Base black (37)</p> <p>*NB: Leather min. 2 chairs in same colour <i>Upcharge for Bolster upholstery pg 1-7**</i> <i>Upcharge polished aluminium</i> <i>Upcharge for felt glides</i> <i>Upcharge for auto-return</i> <i>Upcharge opt.colours stand (black castors/tilt)</i></p>	<p>51 37 32H01-xxx</p> <p>51 xx 32H0B-xxx</p> <p>51 13 32H01-xxx</p> <p>51 xx 32HF1-xxx</p> <p>51 xx 33H01-xxx</p> <p>51 yy 32H01-xxx</p>	<p>PG 1 PG 2 PG 3 PG 4 PG 5 PG 6 PG 7 Leather*</p>	<p>1 015 1 065 1 122 1 179 1 242 1 313 1 413 1 471 144 43 11 47 80</p>
	<p>Chair, medium back 4-winged aluminium base with glides and tilt, turnable. Base black (37)</p> <p>*NB: Leather min. 2 chairs in same colour <i>Upcharge for Bolster upholstery pg 1-7**</i> <i>Upcharge polished aluminium</i> <i>Upcharge for felt glides</i> <i>Upcharge for auto-return</i> <i>Upcharge opt.colours stand (black castors/tilt)</i></p>	<p>51 37 32M01-xxx</p> <p>51 xx 32M0B-xxx</p> <p>51 13 32M01-xxx</p> <p>51 xx 32MF1-xxx</p> <p>51 xx 33M01-xxx</p> <p>51 yy 32M01-xxx</p>	<p>PG 1 PG 2 PG 3 PG 4 PG 5 PG 6 PG 7 Leather*</p>	<p>933 977 1 026 1 076 1 131 1 192 1 279 1 409 144 43 11 47 80</p>
	<p>Chair, high back, 4 metal legs Base white (31) or black (37).</p> <p>*NB: Leather min. 2 chairs in same colour <i>Upcharge for Bolster upholstery pg 1-7**</i> <i>Upcharge for base in chrome (13)</i></p>	<p>51 xx 20H01-xxx</p> <p>51 xx 20H0B-xxx</p> <p>51 13 20H01-xxx</p>	<p>PG 1 PG 2 PG 3 PG 4 PG 5 PG 6 PG 7 Leather*</p>	<p>820 870 927 984 1 047 1 117 1 218 1 276 144 37</p>
	<p>Chair, medium back, 4 metal legs Base white (31) or black (37).</p> <p>*NB: Leather min. 2 chairs in same colour <i>Upcharge for Bolster upholstery pg 1-7**</i> <i>Upcharge for base in chrome (13)</i></p>	<p>51 xx 20M01-xxx</p> <p>51 xx 20M0B-xxx</p> <p>51 13 20M01-xxx</p>	<p>PG 1 PG 2 PG 3 PG 4 PG 5 PG 6 PG 7 Leather*</p>	<p>738 781 831 880 935 996 1 083 1 213 144 37</p>

Illustration	Description	Article number	Price group	EUR
	<p>Chair, high back 4 wooden legs Oak (03) or ash (06).</p> <p>*NB: Leather min. 2 chairs in same colour <i>Upcharge for Bolster upholstery pg 1-7**</i> <i>Upcharge for stained legs; white oak (30), black ash (86), white ash (10), dark ash (76), Burgundy ash (C8), Conifer ash (D3), Smokey Blue ash (D4), Olive ash (D6), Mushroom ash(D7).</i></p>	<p>51 xx 15H01-xxx</p> <p>51 xx 15H0B-xxx</p> <p>51 xx 15H01-xxx</p>	<p>PG 1 PG 2 PG 3 PG 4 PG 5 PG 6 PG 7 Leather*</p>	<p>937 987 1 044 1 101 1 164 1 234 1 335 1 393 144 78</p>
	<p>Chair, medium back 4 wooden legs Oak (03) or ash (06).</p> <p>Conifer ash (D3),</p> <p>*OBS! Läder: min. antal 2 st i samma kulör <i>Upcharge for Bolster upholstery pg 1-7**</i> <i>Upcharge for stained legs; white oak (30), black ash (86), white ash (10), dark ash (76), Burgundy ash (C8), Conifer ash (D3), Smokey Blue ash (D4), Olive ash (D6), Mushroom ash(D7).</i></p>	<p>51 xx 15M01-xxx</p> <p>51 xx 15M0B-xxx</p> <p>51 xx 15M01-xxx</p>	<p>PG 1 PG 2 PG 3 PG 4 PG 5 PG 6 PG 7 Leather*</p>	<p>867 911 960 1 009 1 064 1 125 1 212 1 342 144 78</p>
	<p>New!</p> <p>Chair high back 4 steel legs in black RAL 9005 (37) alternatively Horreds optional colours.</p> <p>*NB: Leather min. 2 chairs in same colour <i>Upcharge for Bolster upholstery pg 1-7**</i> <i>Upcharge for felt glides</i></p>	<p>51 xx 25H01-xxx</p> <p>51 xx 25H0B-xxx</p> <p>51 xx 25HF1-xxx</p>	<p>PG 1 PG 2 PG 3 PG 4 PG 5 PG 6 PG 7 Leather*</p>	<p>807 857 914 970 1 034 1 104 1 205 1 263 144 11</p>
	<p>New!</p> <p>Chair medium back 4 steel legs in black RAL 9005 (37) alternatively Horreds optional colours.</p> <p>*NB: Leather min. 2 chairs in same colour <i>Upcharge for Bolster upholstery pg 1-7**</i> <i>Upcharge for felt glides</i></p>	<p>51 xx 25M01-xxx</p> <p>51 xx 25M0B-xxx</p> <p>51 xx 25MF1-xxx</p>	<p>PG 1 PG 2 PG 3 PG 4 PG 5 PG 6 PG 7 Leather*</p>	<p>754 797 847 896 951 1 012 1 099 1 229 144 11</p>

Illustration	Description	Article number	Price group	EUR
Glove Bolster Cover Design: Fredrik Mattson				
<p style="text-align: center;">Glove BOLSTER COVER</p> <ul style="list-style-type: none"> • Cover fabric for Glove High and Medium. • Channel-stitched upholstery in fabrics from price groups 1-7, with the exception of imitation leather. • With zippers for easy installation on existing chairs. • For more product information, see www.horreds.se 				
	Dressing fabric for Glove High with steel stand	51 BHS -xxx	PG 1	376
	Dressing fabric for Glove High with wooden stand	51 BHT -xxx	PG 2	427
			PG 3	479
			PG 4	531
			PG 5	591
			PG 6	671
			PG 7	790
	Dressing fabric for Glove Medium with steel stand	51 BMS -xxx	PG 1	352
	Dressing fabric for Glove Medium with wooden stand	51 BMT -xxx	PG 2	399
			PG 3	446
			PG 4	493
			PG 5	548
			PG 6	620
			PG 7	728

Description


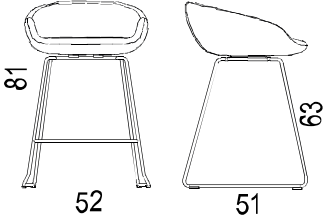
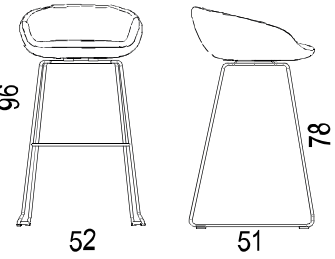
Illustration	Description	Article number	Price group	EUR
<p>Glove Bar Design: Fredrik Mattson</p>				
	<p>Glove Bar</p> <ul style="list-style-type: none"> • Fully upholstered seat of molded cold foam (HR) with metal frame.. • Stand of 12 mm wire. • Upcharge for CMHR-skum: € 31. • For more product information see www.horreds.se <p style="text-align: center;"><u>Stand::</u> Black RAL 9005 smooth gl.30 (37) (Other colours agains quotation)</p>			
	<p>Bar stool with black stand, seating height 630 mm</p> <p><i>*NB:Leather min.2 pcs in same colour Upcharge for felt glides</i></p>	<p>51 37 60B01-xxx</p> <p>51 37</p>	<p>PG 1 PG 2 PG 3 PG 4 PG 5 PG 6 PG 7 Leather*</p>	<p>592 617 645 673 705 739 789 1 040 10</p>
	<p>Bar stool with black stand, seating height 780 mm</p> <p><i>*NB:Leather min.2 pcs in same colour Upcharge for felt glides</i></p>	<p>51 37 61B01-xxx</p> <p>51 37 61BF1-xxx</p>	<p>PG 1 PG 2 PG 3 PG 4 PG 5 PG 6 PG 7 Leather*</p>	<p>647 672 700 729 760 795 845 1 095 10</p>




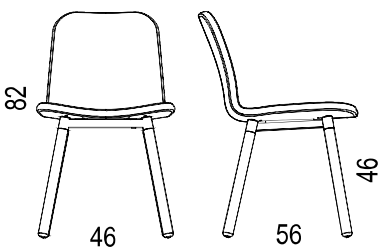
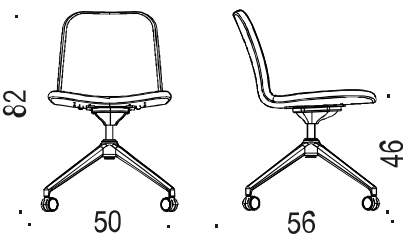
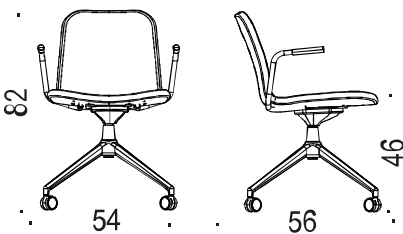
Illustration	Description	Article number	Price group	EUR
Cuba				
				
Cuba chair				
	<ul style="list-style-type: none"> Fully upholstered seat of molded plywood with cold foam.. Wooden legs in clear coated solid oak / ash are standard, stained against upcharge: <ol style="list-style-type: none"> Oak; white pigmented Ash; white pigmented, black stained, dark stained Burgundy ash, Conifer ash, Smokey Blue ash, Olive ash, Mushroom ash. 4-wing black aluminum stand (RAL9005) with/whitout castors. Optional: selected colours, see page 171 4-legged black (RAL 9005) steel. For more product information see www.horreds.se 			
	<p>Chair</p> <p>Wooden legs (cylindrical) in solid oak or ash, clear coated.</p> <p>Seating height 46cm</p> <p>Frame in metal, black RAL 9005</p> <p>Oak (03), Ash (06)</p> <p><i>*NB: Leather min.4 pcs in same colour</i></p> <p><i>Upcharge for stained legs</i></p>	<p>34 xx 1537-xxx</p> <p>34 xx 1037-xxx</p>	<p>PG 1</p> <p>PG 2</p> <p>PG 3</p> <p>PG 4</p> <p>PG 5</p> <p>PG 6</p> <p>PG 7</p> <p>Leather*</p>	<p>481</p> <p>501</p> <p>524</p> <p>546</p> <p>571</p> <p>599</p> <p>639</p> <p>728</p> <p>75</p>
	<p>Chair</p> <p>4-wing aluminum stand, with castors, fixed height, tilt, swivel.</p> <p>Seating height 46cm</p> <p>Black RAL 9005</p> <p><i>*NB: Leather min.4 pcs in same colour</i></p> <p><i>Upcharge for height adj. 42-52 cm</i></p> <p><i>Upcharge for interval braked wheels</i></p> <p><i>Upcharge opt.colour stand (black tilt)</i></p>	<p>34 37 30-xxx</p> <p>34 37 34-xxx</p> <p>34 37 30I-xxx</p>	<p>PG 1</p> <p>PG 2</p> <p>PG 3</p> <p>PG 4</p> <p>PG 5</p> <p>PG 6</p> <p>PG 7</p> <p>Leather*</p>	<p>568</p> <p>589</p> <p>613</p> <p>636</p> <p>662</p> <p>692</p> <p>733</p> <p>828</p> <p>26</p> <p>28</p> <p>80</p>
	<p>Armchair</p> <p>4-wing aluminum stand, with castors, fixed height, tilt, swivel.</p> <p>Seating height 46cm</p> <p>Black RAL 9005</p> <p><i>*NB: Leather min.4 pcs in same colour</i></p> <p><i>Upcharge for height adj. 42-52 cm</i></p> <p><i>Upcharge for interval braked wheels</i></p> <p><i>Upcharge opt.colour stand (black tilt)</i></p>	<p>34 37 31-xxx</p> <p>34 37 35-xxx</p> <p>34 37 31I-xxx</p>	<p>PG 1</p> <p>PG 2</p> <p>PG 3</p> <p>PG 4</p> <p>PG 5</p> <p>PG 6</p> <p>PG 7</p> <p>Leather*</p>	<p>682</p> <p>703</p> <p>727</p> <p>750</p> <p>777</p> <p>806</p> <p>847</p> <p>942</p> <p>26</p> <p>28</p> <p>100</p>

Illustration	Description	Article number	Price group	EUR
	<p>Chair 4-wing aluminum stand, with glides, fixed height, tilt, swivel. Seating height 46cm <i>Black RAL 9005</i></p> <p>*NB: Leather min.4 pcs in same colour <i>Upcharge for felt glides</i> <i>Upcharge opt.colour stand (black tilt)</i></p>	<p>34 37 32-xxx</p> <p>34 37 32F-xxx</p>	<p>PG 1 PG 2 PG 3 PG 4 PG 5 PG 6 PG 7 Leather*</p>	<p>568 589 613 636 662 692 733 828 11 80</p>
	<p>Armchair 4-wing aluminum stand, with glides, fixed height, tilt, swivel. Seating height 46cm <i>Black RAL 9005</i></p> <p>*NB: Leather min.4 pcs in same colour <i>Upcharge for felt glides</i> <i>Upcharge opt.colour stand (black tilt)</i></p>	<p>34 37 33-xxx</p> <p>34 37 33F-xxx</p>	<p>PG 1 PG 2 PG 3 PG 4 PG 5 PG 6 PG 7 Leather*</p>	<p>682 703 727 750 777 806 847 942 11 100</p>
	<p>Chair 4-legged steel RAL9005 Seating height 46cm</p> <p>*NB: Leather min.4 pcs in same colour <i>Upcharge for sliding feet with felt</i> <i>Upcharge opt.colour stand (black tilt)</i></p>	<p>34 37 20-xxx</p> <p>34 37 20F-xxx</p>	<p>PG 1 PG 2 PG 3 PG 4 PG 5 PG 6 PG 7 Leather*</p>	<p>342 362 385 407 432 460 500 589 11 17</p>




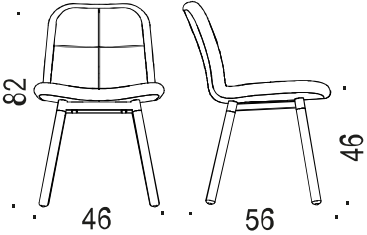
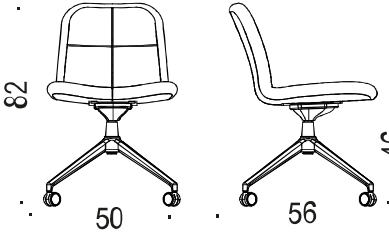
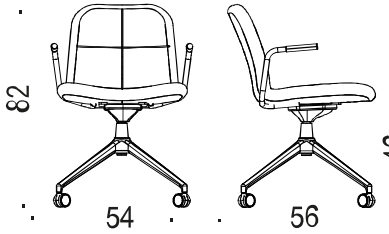

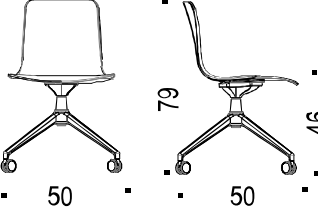

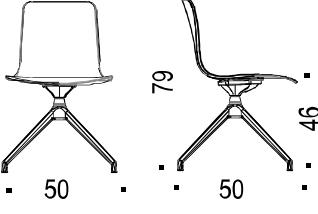
Illustration	Description	Article number	Price group	EUR
<div style="display: flex; justify-content: space-between; align-items: center;"> <div data-bbox="137 203 568 275"> <h2 style="margin: 0;">Cuba quiltad</h2> </div> <div data-bbox="1098 210 1374 259" style="text-align: right;">  MÖBELFAKTA </div> </div>				
<div style="display: flex; justify-content: space-between;"> <div data-bbox="213 300 456 640" style="text-align: center;">  </div> <div data-bbox="571 275 1085 667"> <h3 style="margin: 0;">Cuba, quilted</h3> <ul style="list-style-type: none"> Fully upholstered seat of molded plywood with cold foam. Quilted upholstery which is replaceable. Wooden legs in clear coated solid oak and ash. Stained legs against upcharge: <ol style="list-style-type: none"> 1) Oak; white pigmented 2) Ash; white pigmented, black stained, dark stained Burgundy ash, Conifer ash, Smokey Blue ash, Olive ash, Mushroom ash. 4-wing black (RAL 9005) aluminum stand, with/without castors. Optional: selected colours, see colour chart. 4-legged black (RAL 9005) steel. For more product information see www.horreds.se </div> <div data-bbox="1098 327 1362 651" style="text-align: center;">  </div> </div>				
	<p>Chair with quilted upholstery. Wooden legs (cylindrical) in solid oak (03) or ash (06). Clear coated. Seating height 46cm Frame in metal black RAL 9005</p> <p><i>*: Leather min 4 pcs in same colour</i> <i>Upcharge for stained legs</i></p>	<p>34Q xx 1537-xxx</p> <p>34Q xx 1537-xxx</p>	<p>PG 1 PG 2 PG 3 PG 4 PG 5 PG 6 PG 7 Leather*</p>	<p>540 566 595 623 656 693 747 852 75</p>
	<p>Chair with quilted upholstery. 4-wing aluminum stand w. castors. Fixed height, tilt, rotation. Seating height 46cm <i>Black RAL 9005</i></p> <p><i>*NB:Leather min.4 pcs in same colour</i> <i>Upcharge for height adj. 42-52cm</i> <i>Upcharge for interval braked castors</i> <i>Upcharge opt.colour stand (black tilt)</i></p>	<p>34Q 37 30-xxx</p> <p>34Q 37 34-xxx 34Q 37 30I-xxx</p>	<p>PG 1 PG 2 PG 3 PG 4 PG 5 PG 6 PG 7 Leather*</p>	<p>627 654 684 714 747 786 842 951 26 28 80</p>
	<p>Armchair with quilted upholstery. 4-wing aluminum stand w. castors. Fixed height, tilt, rotation. Seating height 46cm <i>Black RAL 9005</i></p> <p><i>*NB:Leather min.4 pcs in same colour</i> <i>Upcharge for height adj. 42-52cm</i> <i>Upcharge for interval braked castors</i> <i>Upcharge opt.colour stand (black tilt)</i></p>	<p>34Q 37 31-xxx</p> <p>34Q 37 35-xxx 34Q 37 31I-xxx</p>	<p>PG 1 PG 2 PG 3 PG 4 PG 5 PG 6 PG 7 Leather*</p>	<p>741 768 798 828 861 900 956 1 066 26 28 100</p>

Illustration	Description	Article number	Price group	EUR
	<p>Chair with quilted upholstery 4-wing aluminum stand with sliding feet, fixed height, tilt, rotation. Seating height 46cm <i>Black RAL 9005</i></p> <p>*: Leather min.4 pcs in same colour <i>Upcharge for sliding feet with felt</i> <i>Upcharge opt.colour stand (black tilt)</i></p>	<p>34Q 37 32-xxx</p> <p>34Q 37 32F-xxx</p>	<p>PG 1 PG 2 PG 3 PG 4 PG 5 PG 6 PG 7 Leather*</p>	<p>627 654 684 714 747 786 842 951 11 80</p>
	<p>Armchair with quilted upholstery 4-wing aluminum stand with sliding feet, fixed height, tilt, rotation. Seating height 46cm <i>Black RAL 9005</i></p> <p>*: Leather min.4 pcs in same colour <i>Upcharge for sliding feet with felt</i> <i>Upcharge opt.colour stand (black tilt)</i></p>	<p>34Q 37 33-xxx</p> <p>34Q 37 33F-xxx</p>	<p>PG 1 PG 2 PG 3 PG 4 PG 5 PG 6 PG 7 Leather*</p>	<p>741 768 798 828 861 900 956 1 066 11 100</p>
	<p>Chair with quilted upholstery 4-legged steel RAL9005 Seating height 46cm</p> <p>*: Leather min.4 pcs in same colour <i>Upcharge opt.colour stand (black tilt)</i> <i>Tillägg tillv.kulör på stativ (svart vipp)</i></p>	<p>34Q 37 20-xxx</p> <p>34Q 37 20F-xxx</p>	<p>PG 1 PG 2 PG 3 PG 4 PG 5 PG 6 PG 7 Leather*</p>	<p>401 427 456 485 517 554 608 713 11 17</p>

Illustration	Description	Article number	Price group	EUR
Base Design: Anderssen & Voll				
<div style="display: flex; justify-content: space-between;"> <div style="width: 25%;">  </div> <div style="width: 75%;"> <h3 style="margin: 0;">Base 4-wing with castors</h3> <ul style="list-style-type: none"> Chair with pressed seat shell. Fully upholstered. Cold foam padding (CMHR). Thicker upholstery as option. 4-winged aluminum base with castors and tilt function. Castors with polyurethane roller conveyor, suitable for all floors. Price for leather chairs in less than 4 pieces: against quotation För mer produktinformation se www.horreds.se <p style="text-align: center;"><u>Colours stands (xx):</u> 37 Black (RAL 9005) 13 Polished (against upcharge) NB: Model A60 only. <i>(Aother RAL colours against quotation)</i></p> </div> </div>				
	<p>Chair, 4-winged black aluminum stand with castors, fixed height, tilt, fully upholstered</p> <p><i>*Note:Leather min 4 pcs in same colour</i></p> <p><i>Upcharge for thicker upholstery</i></p> <p><i>Upcharge for polished stand</i></p>	<p>65 A60 xx 97-xxx</p> <p>65 A60 xx 97-xxx</p> <p>65 A60 xx 97-xxx</p> <p>65 A60 xx 97-xxx</p> <p>65 A60 xx 97-xxx</p> <p>65 A60 xx 97-xxx</p> <p>65 A60 xx 97-xxx</p> <p>65 A60 xx 97-xxx</p> <p>65 A60 xx 97-xxx</p> <p>65 B61 xx 97-xxx</p> <p>65 A60 13 97-xxx</p>	<p>PG 1</p> <p>PG 2</p> <p>PG 3</p> <p>PG 4</p> <p>PG 5</p> <p>PG 6</p> <p>PG 7</p> <p>Leather*</p>	<p>699</p> <p>724</p> <p>752</p> <p>780</p> <p>811</p> <p>845</p> <p>894</p> <p>1 005</p> <p>60</p> <p>45</p>
<div style="display: flex; justify-content: space-between;"> <div style="width: 25%;">  </div> <div style="width: 75%;"> <h3 style="margin: 0;">Base 4-wing leg stand</h3> <ul style="list-style-type: none"> Chair with pressed seat shell. Fully upholstered.Padding of cold foam (CMHR). Thicker upholstery as option. 4-winged aluminum base with tilt function. Upcharge for felt glides. Price for leather chairs in less than 4 pieces: against quotation Fore more information, see www.horreds.se <p style="text-align: center;"><u>Colours stands (xx):</u> 37 Black (RAL 9005) <i>(Aother RAL colours against quotation)</i></p> </div> </div>				
	<p>Chair, 4-winged black aluminum stand without castors, fixed height, tilt, fully upholstered</p> <p><i>*Note:Leather min 4 pcs in same colour</i></p> <p><i>Upcharge for thicker upholstery</i></p> <p><i>Upcharge for sliding feet with felt</i></p>	<p>65 A62 xx 97-xxx</p> <p>65 A62 xx 97-xxx</p> <p>65 A62 xx 97-xxx</p> <p>65 A62 xx 97-xxx</p> <p>65 A62 xx 97-xxx</p> <p>65 A62 xx 97-xxx</p> <p>65 A62 xx 97-xxx</p> <p>65 A62 xx 97-xxx</p> <p>65 A62 xx 97-xxx</p> <p>65 B62 xx 97-xxx</p>	<p>PG 1</p> <p>PG 2</p> <p>PG 3</p> <p>PG 4</p> <p>PG 5</p> <p>PG 6</p> <p>PG 7</p> <p>Leather*</p>	<p>699</p> <p>724</p> <p>752</p> <p>780</p> <p>811</p> <p>845</p> <p>894</p> <p>1 005</p> <p>60</p> <p>12</p>

Base Design: Anderssen & Voll



Base 5-wing with castors


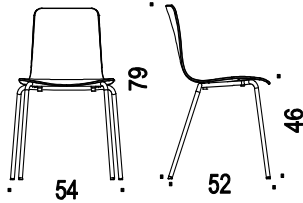
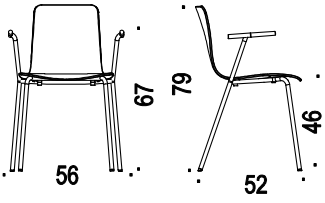
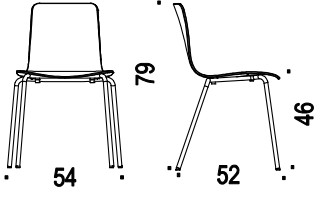
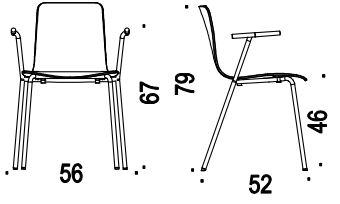
- Chair with pressed seat shell
- Fully upholstered. Cold foam padding (CMHR)
- Kanalsydd klädsel mot tillägg
- Castors with polyurethane roller conveyor, suitable for all floors.
- Thicker upholstery as option.
- Price for leather chairs in less than 4 pieces: against quotation
- For more information, see www.horreds.se

Colours stands (xx):

37 Black (RAL 9005)

(Aother RAL colours against quotation

	<p>Chair, 5-wing black stand with castors, fixed height, tilt, fully upholstered.</p> <p>*NB: Leather min. 4 chairs in same colour</p> <p><i>Upcharge for adjustable height 44-53 cm</i></p> <p><i>Upcharge for interval braked castors</i></p> <p><i>Upcharge for thicker upholstery</i></p>	<p>65 A50 37 97-xxx</p> <p>65 A50 37 97-xxx</p> <p>65 A50 37 97-xxx</p> <p>65 A50 37 97-xxx</p> <p>65 A50 37 97-xxx</p> <p>65 A50 37 97-xxx</p> <p>65 A50 37 97-xxx</p> <p>65 A50 37 97-xxx</p> <p>65 A52 37 97-xxx</p> <p>65 xxx 37 97-xxx</p> <p>65 B50 37 97-xxx</p>	<p>PG 1</p> <p>PG 2</p> <p>PG 3</p> <p>PG 4</p> <p>PG 5</p> <p>PG 6</p> <p>PG 7</p> <p>Leather*</p>	<p>818</p> <p>842</p> <p>870</p> <p>898</p> <p>929</p> <p>963</p> <p>1 012</p> <p>1 124</p> <p>30</p> <p>29</p> <p>60</p>
--	---	--	---	---

Base Design: Anderssen & Voll				
		<p>Base 4-legged stand</p> <ul style="list-style-type: none"> • Stackable chair / armchair with pressed seat shell. • Fully upholstered. Cold foam padding. • Veneered in clear coated oak and dark stained ash. • Stack protection in felt for upholstered chairs. • Recommended stacking height: max 8 charis. • Connectable in version without upholstery. • Stand of 19 mm steel pipe, black TPE armrests, black plastic feet. • Price for leather chairs in less than 4 pieces; against quotation. • For more product information; see www.horreds.se <p><u>Colour stands (xx):</u> 37 Black (RAL 9005) 13 Chrome: Models A11 and A10 only (Other RAL colours against quotation)</p>		
		<p>Chair with upholstered seat shell, Incl stack protection in felt, black or chrome</p> <p>*Note:Leather min.4 chairs in same color</p> <p><i>Upcharge for sliding feet with felt</i> <i>Upcharge for thicker upholstery</i></p>	<p>65 A11 xx 97-xxx 65 A11 xx 97-xxx 65 A11 xx 97-xxx 65 A11 xx 97-xxx 65 A11 xx 97-xxx 65 A11 xx 97-xxx 65 A11 xx 97-xxx 65 A11 xx 97-xxx 65 A11 xx 97-xxx 65 A11 xx 97-xxx 65 A11 xx 97-xxx 65 A11 xx 97-xxx 65 B11 xx 97-xxx</p>	<p>PG 1 583 PG 2 607 PG 3 635 PG 4 663 PG 5 694 PG 6 728 PG 7 777 Leather* 888 30 60</p>
		<p>Armchair with upholstered seat shell, Incl stack protection in felt, black. Black stand</p> <p>*Note: Leather min.4 chairs in same color</p> <p><i>Upcharge for sliding feet with felt</i> <i>Upcharge for thicker upholstery</i></p>	<p>65 A21 37 97-xxx 65 A21 37 97-xxx 65 A21 37 97-xxx 65 A21 37 97-xxx 65 A21 37 97-xxx 65 A21 37 97-xxx 65 A21 37 97-xxx 65 A21 37 97-xxx 65 A21 37 97-xxx 65 A21 37 97-xxx 65 A21 37 97-xxx 65 A21 37 97-xxx 65 A21 37 97-xxx 65 B21 37 97-xxx</p>	<p>PG 1 774 PG 2 799 PG 3 826 PG 4 854 PG 5 885 PG 6 920 PG 7 969 Leather* 1 080 30 60</p>
		<p>Chair with veneered seat shell, black or chrome</p> <p><i>Upcharge for connecting fittings</i> <i>Upcharge for sliding feet with felt</i></p>	<p>65 A10 xx 03 65 A10 xx 76 65 A12 xx xx 65 A10 xx xxF</p>	<p>Oak 407 Dark st. ash 407 66 30</p>
		<p>Armchair with veneered seat shell, black.</p> <p><i>Upcharge for connecting fittings</i> <i>Upcharge for sliding feet with felt</i></p>	<p>65 A20 37 03 65 A20 37 76 65 A22 37 xx 65 A22 37 xxF</p>	<p>Oak 601 Dark st. ash 601 66 30</p>

Base Design: Anderssen & Voll

Base with sled base



- Stackable chair with pressed seat shell
- Fully upholstered. Cold foam padding.
- Veneered in oak nature and dark stained ash
- Sled base of 12 mm wire
- Stack protection in felt for upholstered chairs.
- Connectable
- Price for leather chairs in less than 4 pieces: against quotation
- For more product information: see www.horreds.se

Colour stands (xx):

37 Black (RAL 9005)

(Other RAL colours against quotation)

	<p>Chair with black sled base, fully upholstered</p> <p>*NB: Leather min.4 chairs in same colour</p> <p><i>Upcharge for thicker upholstery</i></p> <p><i>Upcharge for sliding feet with felt</i></p> <p><i>Upcharge cost for connecting fittings</i></p>	<p>65 A40 37 97-xxx</p> <p>65 A40 37 97-xxx</p> <p>65 A40 37 97-xxx</p> <p>65 A40 37 97-xxx</p> <p>65 A40 37 97-xxx</p> <p>65 A40 37 97-xxx</p> <p>65 A40 37 97-xxx</p> <p>65 A40 37 97-xxx</p> <p>65 A40 37 97-xxx</p> <p>65 B40 37 97-xxx</p> <p>65 A40 37 97-Fxxx</p> <p>65 A42 37 97-xxx</p>	<p>PG 1</p> <p>PG 2</p> <p>PG 3</p> <p>PG 4</p> <p>PG 5</p> <p>PG 6</p> <p>PG 7</p> <p>Leather*</p>	<p>505</p> <p>529</p> <p>557</p> <p>585</p> <p>616</p> <p>650</p> <p>699</p> <p>810</p> <p>60</p> <p>12</p> <p>18</p>
	<p>Chair with black sled base, veneered seat shell</p> <p><i>Upcharge for sliding feet with felt</i></p> <p><i>Upcharge cost for connecting fittings</i></p>	<p>65 A40 37 03</p> <p>65 A40 37 76</p> <p>65 A40 37 xxF</p> <p>65 A42 37 xx</p>	<p>Oak</p> <p>Dark st. ash</p>	<p>339</p> <p>339</p> <p>12</p> <p>18</p>



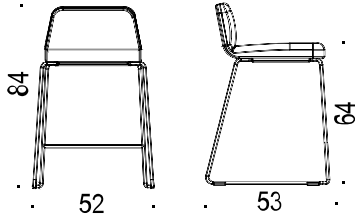
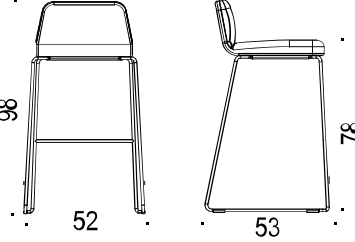
Illustration	Description	Article number	Price group	EUR
VX Barpoll				
	<p>VX BAR STOOL</p> <ul style="list-style-type: none"> • Upholstered seat of molded plywood with cold foam • Stand of 12 mm wire, stackable 4 pcs • Stack protection in molded felt (anthracite gray) • For more product information; see www.horreds.se <p><u>Colour stand:</u> Svart RAL 9005 (37)</p> <p><u>Optional colours:</u> RAL 3007 Black red (3D), RAL 5008 Grey blue (3C), RAL 6013 Reed green (3K), RAL 7044 Silk grey (3A)</p>			
	<p>Bar stool, seat height 640 mm</p> <p>*NB: Leather min. 2 chairs in same colour</p> <p><i>Upcharge for optional colours</i></p> <p><i>Upcharge for sliding feet with felt</i></p>	<p>34 37 07290-xxx</p> <p>34 yy 07290-xxx</p> <p>34 xx 07290Fxxx</p>	<p>PG 1</p> <p>PG 2</p> <p>PG 3</p> <p>PG 4</p> <p>PG 5</p> <p>PG 6</p> <p>PG 7</p> <p>Leather*</p>	<p>491</p> <p>515</p> <p>543</p> <p>570</p> <p>601</p> <p>636</p> <p>685</p> <p>930</p> <p>27</p> <p>12</p>
	<p>Bar stool, seat height 780 mm</p> <p>*NB: Leather min. 2 chairs in same colour</p> <p><i>Upcharge for optional colours</i></p> <p><i>Upcharge for sliding feet with felt</i></p>	<p>34 37 07295-xxx</p> <p>34 yy 07295-xxx</p> <p>34 xx 07295Fxxx</p>	<p>PG 1</p> <p>PG 2</p> <p>PG 3</p> <p>PG 4</p> <p>PG 5</p> <p>PG 6</p> <p>PG 7</p> <p>Leather*</p>	<p>511</p> <p>535</p> <p>563</p> <p>591</p> <p>622</p> <p>656</p> <p>705</p> <p>950</p> <p>27</p> <p>12</p>



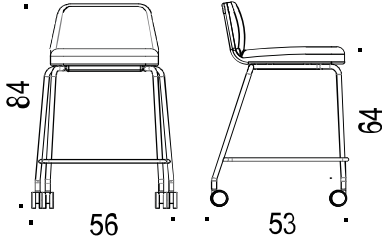



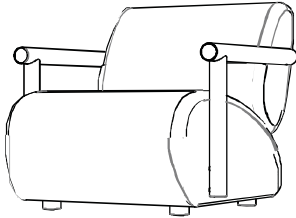
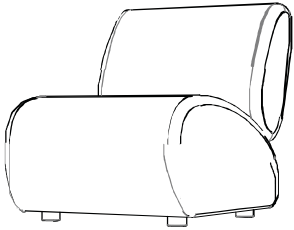
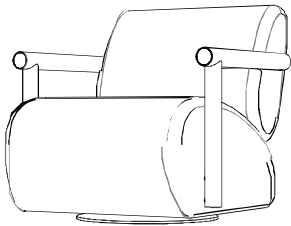
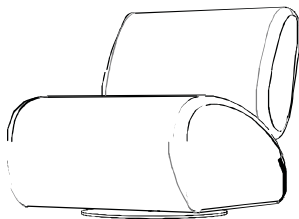
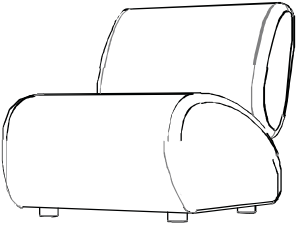
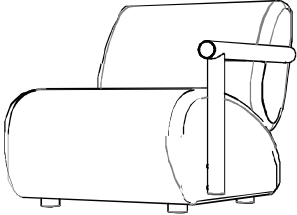
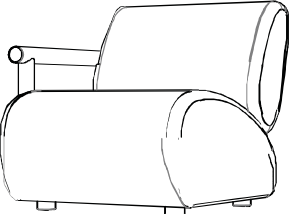
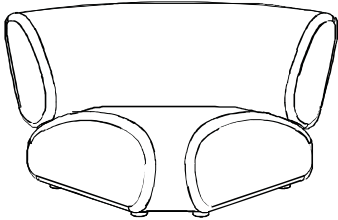
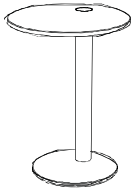
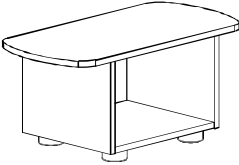
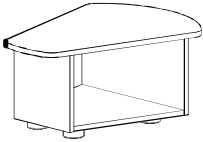
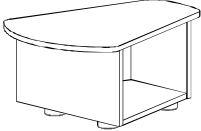
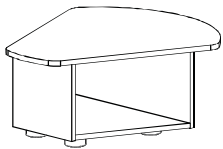
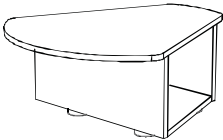
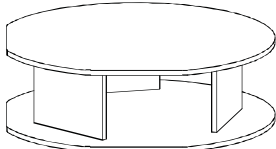
Illustration	Description	Article number	Price group	EUR
VX Barpall med hjul				
	<p>VX Bar stool with castors</p>  <ul style="list-style-type: none"> • Upholstered seat of molded plywood with cold foam. • Stand made of 19mm steel tube, footrest made of 14mm wire.. • Interval braked castors, polyurethane roller track, suitable for all floors. • Stack coverin molded felt, anthracite grey. • or more product information see www.horreds.se <p><u>Colour stand:</u> Svart RAL 9005 (37) Optional colours: RAL 3007 Black red (3D), RAL 5008 Grey blue (3C), RAL 6013 Reed green (3K), RAL 7044 Silk grey (3A)</p>			
	<p>4-legged with castors, black, seat height 640 mm</p> <p>*NB: Leather minimum number 2 pcs in the same colour. <i>Upcharge for optional colours</i></p>	<p>34 37 08993-xxx</p> <p>34 yy 08993-xxx</p>	<p>PG 1 PG 2 PG 3 PG 4 PG 5 PG 6 PG 7 Leather*</p>	<p>548 572 600 628 659 693 742 987 27</p>

Illustration	Description	Article number	Price group	EUR
LOG Design: Studio Stockholm Arkitektur				
<div style="display: flex; justify-content: space-between; align-items: center;"> <div style="flex: 1;">  </div> <div style="flex: 2;"> <p>LOG Armchair / Modular sofa</p> <ul style="list-style-type: none"> • Fully upholstered modular sofa with a seat height of 41 cm • Wood and metal frame with HR foam. • CMHR foam upcharge € 148 / seating module. • Legs in solid oak, height 30mm. • For different fabrics in the seat and back, the price of the higher fabric group plus an upcharge of € 121 applies. • Coupling fittings to be ordered separately. • Leather modules against quotation • Configurator to quickly see the price for your desired setup; see www.horreds.se/Products/Seating furniture/Log • For more product information see www.horreds.se </div> <div style="flex: 1; text-align: right;">   </div> </div>				
Fåtöljer				
	<p>Armchair with feet and armrests in hard vax oiled oak (D5) or black stained oak (73).</p> <ul style="list-style-type: none"> • Width 77cm • Height 74cm (height armrests 56cm) • Depth 85cm • Seat height 41c, <p>Can not be coupled</p>	27 xx 202-xxx	PG 1 PG 2 PG 3 PG 4 PG 5 PG 6 PG 7	2 161 2 240 2 318 2 396 2 487 2 607 2 787
	<p>Chair with feet in hard vax oiled oak (D5) or black stained oak 73)</p> <ul style="list-style-type: none"> • Width 65cm • Height 74cm • Depth 85cm • Seat height 41cm 	27 xx 200-xxx	PG 1 PG 2 PG 3 PG 4 PG 5 PG 6 PG 7	1 501 1 580 1 658 1 736 1 827 1 947 2 127
	<p>Armchair swivel with auto return. With armrest in hard vax oiled oak (D5) or blackstained oak (73). Black footplate.</p> <ul style="list-style-type: none"> • Width 770mm • Height 740mm (höjd armstöd 565mm) • Depth 850mm • Seat height 410mm <p>Can not be coupled</p>	27 xx 10202-xxx	PG 1 PG 2 PG 3 PG 4 PG 5 PG 6 PG 7	2 568 2 646 2 725 2 803 2 893 3 013 3 194
	<p>Armchair swivel with auto return. Black footplate.</p> <ul style="list-style-type: none"> • Width 65cm • Height 74cm • Depth 85cm • Seat height 41cm <p>Can not be coupled</p>	27 00 10200-xxx	PG 1 PG 2 PG 3 PG 4 PG 5 PG 6 PG 7	1 908 1 987 2 065 2 143 2 234 2 353 2 534

	Modular sofa			
	<p>Seating module with back. Feet in hard vax poëed pal (D5) or black stained oak (73)</p> <ul style="list-style-type: none"> • Width 65cm • Height 74cm • Depth 85cm • Seat height 41cm <p>Coupling fitting</p>	27 xx 200-xxx	PG 1 PG 2 PG 3 PG 4 PG 5 PG 6 PG 7	1 501 1 580 1 658 1 736 1 827 1 947 2 127
		27001		23
	<p>Seating module with back, armrest left side. Feet and armrest in hard vax oiled oak (D5) or black stained oak (73)</p> <ul style="list-style-type: none"> • Width 71cm • Height 74cm,(height armrests 56cm) • Depth 85cm • Seat height 41cm <p>Coupling fitting</p>	27 xx 201-xxx	PG 1 PG 2 PG 3 PG 4 PG 5 PG 6 PG 7	1 831 1 910 1 988 2 066 2 157 2 277 2 457
		27001		23
	<p>Seating module with back, armrest right side. Feet and armrest in hard vax oiled oak (D5) or black stained oak (73)</p> <ul style="list-style-type: none"> • Width 71cm • Height 74cm(height armrests 56cm) • Depth 85cm • Seat height 41cm <p>Coupling fitting</p>	27 xx 203-xxx	PG 1 PG 2 PG 3 PG 4 PG 5 PG 6 PG 7	1 831 1 910 1 988 2 066 2 157 2 277 2 457
		27001		23
	<p>Corner module w. back. Feet in hard vax oiled oak (D5) or black stained oak (73).</p> <ul style="list-style-type: none"> • Widht 95cm • Height 74cm • Depth 95cm • Seat height 41cm <p>Coupling fittings (1/joint)</p> <p>Note: connect to seat mdódules, not gainst coupling modules.</p>	27 xx 300-xxx	PG 1 PG 2 PG 3 PG 4 PG 5 PG 6 PG 7	2 333 2 444 2 556 2 666 2 795 2 966 3 223
		27001		23
	<p>Laptop table. Top, leg and foot in hard vax oiled oak or black stained oak. Black metal parts.</p> <ul style="list-style-type: none"> • Height 60cm • Top Ø40cm • Foot Ø30cm 	27 D5 09245 27 73 09245	Vax oiled Black stain	758 758

<h3 style="text-align: center;">Kopplingsmoduler</h3> <ul style="list-style-type: none"> • Coupling modules in hard vax oiled oak or black stained oak. • Height 29cm. • For connection between 2 seating modules. • Not intended as stand-alone modules • Electrical outlet as an option 				
	Table connection, straight, in hard vax oiled oak or black stained oak. Height 29cm.	27 D5 09130 27 73 09130	Vax oiled Black stain	561 561
	Same as above but with hole for 1 power outlet at the front	27 D5 09130K 27 73 09130K	Vax oiled Black stain	561 561
	Coupling fittings (1/joint)	27001		23
	Table coupling, 30° inside, in hard vax oiled oak or black stained oak. Height 29cm.	27 D5 09135I 27 73 09135I	Vax oiled Black stain	672 672
	Same as above but with hole for 1 power outlet at the front	27 D5 09135IK 27 73 09135IK	Vax oiled Black stain	672 672
	Coupling fittings (1/joint)	27001		23
	Table coupling, 30° outside, in hard vax oiled oak or black stained oak. Height 29cm.	27 D5 09135U 27 73 09135U	Vax oiled Black stain	672 672
	Same as above but with hole for 1 power outlet at the front	27 D5 09135UK 27 73 09135UK	Vax oiled Black stain	672 672
	Coupling fittings (1/joint)	27001		23
	Table coupling, 45° inside, in hard vax oiled oak or black stained oak. Height 29cm.	27 D5 09140I 27 73 09140I	Vax oiled Black stain	710 710
	Same as above but with hole for 1 power outlet at the front	27 D5 09140IK 27 73 09140I	Vax oiled Black stain	710 710
	Coupling fittings (1/joint)	27001		23
	Table coupling, 45° outside, in hard vax oiled oak or black stained oak. Height 29cm.	27 D5 09140U 27 73 09140U	Vax oiled Black stain	710 710
	Same as above but with hole for 1 power outlet at the front	27 D5 09140UK 27 73 09140UK	Vax oiled Black stain	710 710
	Coupling fittings (1/joint)	27001		23
	Table coupling, corner 90°, in hard vax oiled oak or black stained oak. Height 29cm. (not available with power outlet)	27 D5 09125 27 73 09125	Vax oiled Black stain	798 798
	Coupling fittings (1/joint)	27001		23

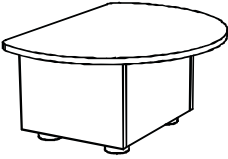
	<p>Table coupling / final module in hard wax oiled oak or black stained oak .Height 29cm. Connects to straight seating module (not corner module). Width 45cm, height 29cm.</p>	<p>27 D5 09185 27 73 09185</p>	<p>Vax oiled Black stain</p>	<p>593 593</p>
	<p>Same as above but with hole for 1 power outlet left side</p>	<p>27 D5 09185KV 27 73 09185KV</p>	<p>Vax oiled Black stain</p>	<p>593 593</p>
	<p>Same as above but with hole for 1 power outlet right side</p>	<p>27 D5 09185KH 27 73 09185KH</p>	<p>Vax oiled Black stain</p>	<p>593 593</p>
	<p>Kopplingsbeslag (1/skarv)</p>	<p>27001</p>		<p>23</p>
	<p>Power outlets to coupling modules</p>			
	<p>Powerdot 1 x power incl cable entry 51 mm</p>	<p>935 -PM50 935 -PM50W</p>	<p>Black White</p>	<p>65 65</p>
	<p>Powerdot 2 x USB-C PD charger incl cable entry 51 mm</p>	<p>935 -PM52 935 -PM52W</p>	<p>Black White</p>	<p>149 149</p>


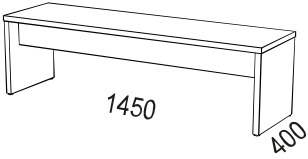
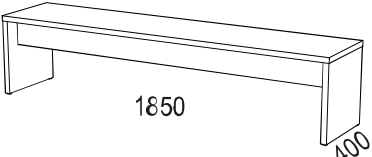
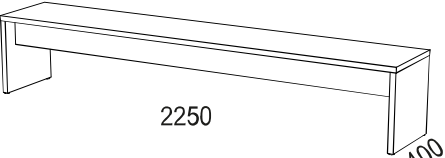
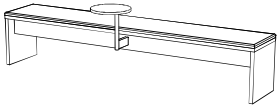
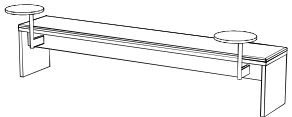
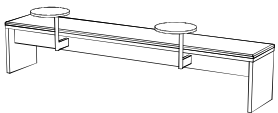
Illustration	Description	Article number	Price group	EUR
Nomono Bench Design: Fredrik Mattson				
	<p>Nomono BENCH</p> <ul style="list-style-type: none"> Nomono Bench is made from 28mm mdf lamella.. 90 degree corners with straight, matching edge. Material: Oak (03) White oak (30) Burgundy ash (C8) Ash (06) White ash (10) Conifer ash (D3) Black st. ash (86) Smokey Blue ash (D4) Dark stained ask (76) Olive ash (D6) Mushroom ash (D7) Available in 3 lengths; 1450mm, 1850mm, 2250mm Seat height in veneer 450mm, seat height with cushion 460mm. Depth 400mm Table and / or electrical outlet as an option. Delivered unassembled. For more product information see www.horreds.se 			
	<p>Längd 1450mm</p> <p>Bench with veneer seat or upholstered seat cushion</p> <p>*NB:min. 2 chairs in same colour</p>	<p>53 xx 0145A</p> <p>53 xx 0145A-x</p> <p>53 xx 0145A-x</p> <p>53 xx 0145A-x</p> <p>53 xx 0145A-x</p> <p>53 xx 0145A-x</p> <p>53 xx 0145A-x</p> <p>53 xx 0145A-x</p> <p>53 xx 0145A-x</p>	<p>Veneered seat</p> <p>PG 1</p> <p>PG 2</p> <p>PG 3</p> <p>PG 4</p> <p>PG 5</p> <p>PG 6</p> <p>PG 7</p> <p>Leather*</p>	<p>1 398</p> <p>1 486</p> <p>1 517</p> <p>1 551</p> <p>1 584</p> <p>1 623</p> <p>1 676</p> <p>1 750</p> <p>1 927</p>
	<p>Lenght 1850mm</p> <p>Bench with veneer seat or upholstered seat cushion</p> <p>*NB:min. 2 chairs in same colour</p>	<p>53 xx 0185A</p> <p>53 xx 0185A-x</p> <p>53 xx 0185A-x</p> <p>53 xx 0185A-x</p> <p>53 xx 0185A-x</p> <p>53 xx 0185A-x</p> <p>53 xx 0185A-x</p> <p>53 xx 0185A-x</p> <p>53 xx 0185A-x</p>	<p>Veneered seat</p> <p>PG 1</p> <p>PG 2</p> <p>PG 3</p> <p>PG 4</p> <p>PG 5</p> <p>PG 6</p> <p>PG 7</p> <p>Leather*</p>	<p>1 534</p> <p>1 653</p> <p>1 695</p> <p>1 740</p> <p>1 785</p> <p>1 838</p> <p>1 910</p> <p>2 010</p> <p>2 063</p>
	<p>Length 2250mm</p> <p>Bench with veneer seat or upholstered seat cushion</p> <p>*NB:min. 2 chairs in same colour</p>	<p>53 xx 0225A</p> <p>53 xx 0225A-x</p> <p>53 xx 0225A-x</p> <p>53 xx 0225A-x</p> <p>53 xx 0225A-x</p> <p>53 xx 0225A-x</p> <p>53 xx 0225A-x</p> <p>53 xx 0225A-x</p> <p>53 xx 0225A-x</p>	<p>Veneered seat</p> <p>PG 1</p> <p>PG 2</p> <p>PG 3</p> <p>PG 4</p> <p>PG 5</p> <p>PG 6</p> <p>PG 7</p> <p>Leather*</p>	<p>1 670</p> <p>1 811</p> <p>1 861</p> <p>1 915</p> <p>1 968</p> <p>2 031</p> <p>2 115</p> <p>2 234</p> <p>2 200</p>
OPTIONS:				
	<p>E. Add.fee for 1xpower, centred</p> <p>G.Add.fee for 1xtable,centred</p> <p>F. Add.fee 1xpower & 1xtable,centr.</p>	<p>53 xx xxxxE-x</p> <p>53 xx BxxxG-x</p> <p>53 xx BxxxF-x</p>		<p>63</p> <p>213</p> <p>277</p>
	<p>B. Add.fee for 2xpower, centred</p> <p>D. Add.fee for 2xtable,centred</p> <p>C. Add.fee 2xpower & 2xtable,centr.</p>	<p>53 xx xxxxB-x</p> <p>53 xx BxxxD-x</p> <p>53 xx BxxxC-x</p>		<p>105</p> <p>355</p> <p>461</p>
	<p>H. Add.fee 2xtables. For bench 225 cm only.</p> <p>I. Add.fee 2xtables&power, For bench 225 cm only.</p>	<p>53 xx B225H-x</p> <p>53 xx B225I-x</p>		<p>355</p> <p>461</p>

Illustration	Description	Article number	EUR																																												
Mute Focus Design: Fredrik Mattson																																															
Mute Focus SEATING FURNITURE																																															
	<ul style="list-style-type: none"> • Frame in lacquered or veneered chipboard. • Padding in HR foam. CMHR against upcharge. • Seat height 46 cm • Delivered assembled, only the table top needs to be assembled. • For more produk information see www.horreds.se 	<p><u>White lacquer:</u> NCS 0300-N <u>Veneer group 1:</u> Oak (03), Ash (06) <u>Veneer group 2:</u> Black stained ash (86), Dark stained ash (76), White pigm.oak (30), White pigmented ash (10), Burgundy ash (C8), Conifer ash (D3), Smokey Blue ash (D4), Olive ash (D6), Mushroom ash (D7).</p>																																													
																																															
<i>Mute Focus Low & Mute Focus, fully upholstered</i>		<i>Mute Focus Low & Mute Focus, veneered outside</i>																																													
	<p>Mute Focus Low, left, fully upholstered, 122x77x79cm. Incl. 1xpower + 1xdouble USB-C charger (PM50+52) Black metal legs. Delivered assembled, only the table needs to be assembled. Max.weight for table top: 50 kg. <i>Upcharge for CMHR</i></p>	55Fxx 400V-xxx	<table border="1"> <thead> <tr> <th>Fabric group</th> <th>Table white lacquer</th> <th>Table optional NCS</th> <th>Table veneer group 1</th> <th>Table veneer group 2</th> </tr> </thead> <tbody> <tr><td>PG 1</td><td>3 806</td><td>3 806</td><td>3 806</td><td>3 806</td></tr> <tr><td>PG 2</td><td>4 001</td><td>4 001</td><td>4 001</td><td>4 001</td></tr> <tr><td>PG 3</td><td>4 222</td><td>4 222</td><td>4 222</td><td>4 222</td></tr> <tr><td>PG 4</td><td>4 443</td><td>4 443</td><td>4 443</td><td>4 443</td></tr> <tr><td>PG 5</td><td>4 691</td><td>4 691</td><td>4 691</td><td>4 691</td></tr> <tr><td>PG 6</td><td>4 964</td><td>4 964</td><td>4 964</td><td>4 964</td></tr> <tr><td>PG 7</td><td>5 355</td><td>5 355</td><td>5 355</td><td>5 355</td></tr> </tbody> </table>	Fabric group	Table white lacquer	Table optional NCS	Table veneer group 1	Table veneer group 2	PG 1	3 806	3 806	3 806	3 806	PG 2	4 001	4 001	4 001	4 001	PG 3	4 222	4 222	4 222	4 222	PG 4	4 443	4 443	4 443	4 443	PG 5	4 691	4 691	4 691	4 691	PG 6	4 964	4 964	4 964	4 964	PG 7	5 355	5 355	5 355	5 355	Table white lacquer	Table optional NCS	Table veneer group 1	Table veneer group 2
Fabric group	Table white lacquer	Table optional NCS	Table veneer group 1	Table veneer group 2																																											
PG 1	3 806	3 806	3 806	3 806																																											
PG 2	4 001	4 001	4 001	4 001																																											
PG 3	4 222	4 222	4 222	4 222																																											
PG 4	4 443	4 443	4 443	4 443																																											
PG 5	4 691	4 691	4 691	4 691																																											
PG 6	4 964	4 964	4 964	4 964																																											
PG 7	5 355	5 355	5 355	5 355																																											
	<p>Mute Focus Low, right, fully upholstered, 122x77x79cm. Incl. 1xpower + 1xdouble USB-C charger (PM50+52) Black metal legs. Delivered assembled, only the table needs to be assembled. Max.weight for table top: 50 kg. <i>Upcharge for CMHR</i></p>	55Fxx 400H-xxx	<table border="1"> <tbody> <tr><td>PG 1</td><td>3 806</td><td>3 806</td><td>3 806</td><td>3 806</td></tr> <tr><td>PG 2</td><td>4 001</td><td>4 001</td><td>4 001</td><td>4 001</td></tr> <tr><td>PG 3</td><td>4 222</td><td>4 222</td><td>4 222</td><td>4 222</td></tr> <tr><td>PG 4</td><td>4 443</td><td>4 443</td><td>4 443</td><td>4 443</td></tr> <tr><td>PG 5</td><td>4 691</td><td>4 691</td><td>4 691</td><td>4 691</td></tr> <tr><td>PG 6</td><td>4 964</td><td>4 964</td><td>4 964</td><td>4 964</td></tr> <tr><td>PG 7</td><td>5 199</td><td>5 199</td><td>5 199</td><td>5 199</td></tr> </tbody> </table>	PG 1	3 806	3 806	3 806	3 806	PG 2	4 001	4 001	4 001	4 001	PG 3	4 222	4 222	4 222	4 222	PG 4	4 443	4 443	4 443	4 443	PG 5	4 691	4 691	4 691	4 691	PG 6	4 964	4 964	4 964	4 964	PG 7	5 199	5 199	5 199	5 199	Table white lacquer	Table optional NCS	Table veneer group 1	Table veneer group 2					
PG 1	3 806	3 806	3 806	3 806																																											
PG 2	4 001	4 001	4 001	4 001																																											
PG 3	4 222	4 222	4 222	4 222																																											
PG 4	4 443	4 443	4 443	4 443																																											
PG 5	4 691	4 691	4 691	4 691																																											
PG 6	4 964	4 964	4 964	4 964																																											
PG 7	5 199	5 199	5 199	5 199																																											
			77	77	77	77																																									
			8	8	8	8																																									

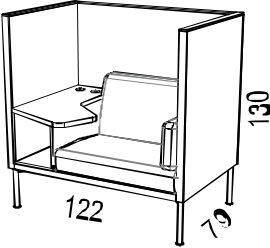
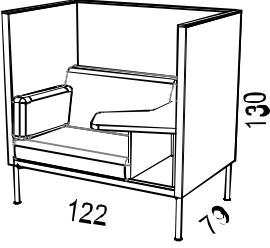
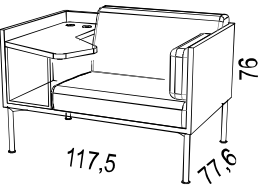
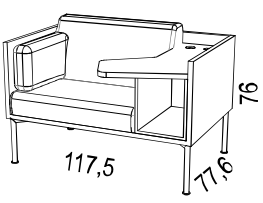
Illustration	Description	Article number	EUR				
			Fabric group	Table white lacquer	Table optional NCS	Table veneer group 1	Table veneer group 2
	<p>Mute Focus left, fully upholstered. 122x130x79cm. Incl. 1xpower + 1xdouble USB-C charger (PM50+52) Delivered assembled, only the table needs to be assembled. Max.weight for table top: 50 kg. <i>Upcharge for CMHR</i></p>	55Fxx 300V-xxx	PG 1	4 189	4 189	4 189	4 189
			PG 2	4 484	4 484	4 484	4 484
			PG 3	4 818	4 818	4 818	4 818
			PG 4	5 152	5 152	5 152	5 152
			PG 5	5 525	5 525	5 525	5 525
			PG 6	5 938	5 938	5 938	5 938
			PG 7	6 528	6 528	6 528	6 528
				99	99	99	99
	<p>Mute Focus right, fully upholstered. 122x130x79cm. Incl. 1xpower + 1xdouble USB-C charger (PM50+52) Delivered assembled, only the table needs to be assembled. Max.weight for table top: 50 kg. <i>Upcharge for CMHR</i></p>	55Fxx 300H-xxx	PG 1	4 189	4 189	4 189	4 189
			PG 2	4 484	4 484	4 484	4 484
			PG 3	4 818	4 818	4 818	4 818
			PG 4	5 152	5 152	5 152	5 152
			PG 5	5 525	5 525	5 525	5 525
			PG 6	5 938	5 938	5 938	5 938
			PG 7	6 528	6 528	6 528	6 528
				99	99	99	99
	<p>Mute Focus Low, left, 117,5x76x77,6cm. Incl. 1xpower + 1xdouble USB-C charger (PM50+52) Black metal legs. Delivered assembled, only the table needs to be assembled. Max.weight for table top: 50 kg. <i>Upcharge for CMHR</i></p>	55Fxx 200V-xxx	Fabric group	White laquer	Optional NCS	Veneer group 1	Veneer group 2
			PG 1	3 941	4 357	4 484	4 484
			PG 2	4 015	4 432	4 558	4 558
			PG 3	4 090	4 506	4 633	4 633
			PG 4	4 164	4 581	4 707	4 707
			PG 5	4 250	4 667	4 794	4 794
			PG 6	4 365	4 782	4 908	4 908
			PG 7	4 538	4 954	5 081	5 081
Leather	4 861	5 277	5 404	5 404			
	50	50	50	50			
	<p>Mute Focus Low, right, 117,5x76x77,6cm. Incl. 1xpower + 1xdouble USB-C charger (PM50+52) Black metal legs. Delivered assembled, only the table needs to be assembled. Max.weight for table top: 50 kg. <i>Upcharge for CMHR</i></p>	55Fxx 200H-xxx	PG 1	3 941	4 357	4 484	4 484
			PG 2	4 015	4 432	4 558	4 558
			PG 3	4 090	4 506	4 633	4 633
			PG 4	4 164	4 581	4 707	4 707
			PG 5	4 250	4 667	4 794	4 794
			PG 6	4 365	4 782	4 908	4 908
			PG 7	4 538	4 954	5 081	5 081
			Leather	4 861	5 277	5 404	5 404
	50	50	50	50			

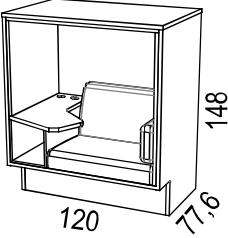
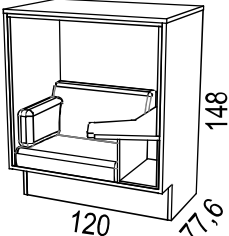
Illustration	Description	Article number	EUR				
			Fabric group	White laquer	Optional NCS	Veneer group 1	Veneer group 2
	<p>Mute Focus vänster 120x148x77,6cm. Inkl. 1x el + 1x dubbel USB-C laddare (PM50+52) Led-belysning. Levereras monterad, endast bordet behöver eftermonteras. Max.belastning bords- skiva: 50 kg. <i>Tillägg för CMHR</i></p>	55Fxx 100V-xxx	PG 1	5 616	6 114	6 786	6 786
			PG 2	5 829	6 327	6 999	6 999
			PG 3	6 042	6 540	7 212	7 212
			PG 4	6 255	6 753	7 425	7 425
			PG 5	6 500	6 998	7 670	7 670
			PG 6	6 828	7 326	7 998	7 998
			PG 7	7 320	7 818	8 490	8 490
			Leather	7 411	7 908	8 580	8 580
				87	87	87	87
	<p>Mute Focus höger 120x148x77,6cm. Inkl. 1x el + 1x dubbel USB-C laddare (PM50+52) Led-belysning. Levereras monterad, endast bordet behöver eftermonteras. Max.belastning bords- skiva: 50 kg. <i>Tillägg för CMHR</i></p>	55Fxx 100H-xxx	PG 1	5 616	6 114	6 786	6 786
			PG 2	5 829	6 327	6 999	6 999
			PG 3	6 042	6 540	7 212	7 212
			PG 4	6 255	6 753	7 425	7 425
			PG 5	6 500	6 998	7 670	7 670
			PG 6	6 828	7 326	7 998	7 998
			PG 7	7 320	7 818	8 490	8 490
			Leather	7 411	7 908	8 580	8 580
				87	87	87	87


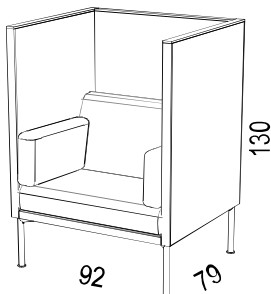
Illustration	Description	Article number	EUR	
<p>Mute Focus fåtölj Design: Fredrik Mattson</p>				
	<p>Mute Focus Easy chair</p> <ul style="list-style-type: none"> • Upholstered easy chair with padding in HR foam • Seat height 46 cm • Delivered assembled • For more produkt information see; www.horreds.se 			
	<p>Mute Focus easy chair, upholstered 92x130x79cm Seat height 46cm Black metal legs. Delivered assembled.</p>	<p>55F 500 -xxx</p>	<p>PG 1 PG 2 PG 3 PG 4 PG 5 PG 6 PG 7</p>	<p>2 713 2 992 3 270 3 545 3 867 4 293 4 933</p>

Illustration	Description	Article number	EUR
--------------	-------------	----------------	-----

Mute Floor Design: Fredrik Mattson

Mute Floor SEATING FURNITURE



- Mute is made of lacquered alternatively veneered particle board
- Padding in HR foam. CMHR against upcharge.
- Sitthöjd 46 cm
- Mute Floorx4 och Mute Floorx2 are delivered unassembled. Mute Floorx1 is delivered assembled. If you wish to have it sent unassembled, please notify customer service.
- For more product information see www.horreds.se

White lacquer: NCS 0300-N
Veneer group 1: Oak (03), Ash (06)
Veneer group 2: Black stained.Ash (86), Dark stained Ash (76),
 White pigm.Oak (30), White pigmented Ash (10),
 Black ash (86), Dark ash (76), White oak (30), White ash (10),
 Burgundy ash (C8), Conifer ash (D3) Smokey Blue ash (D4),
 Olive ash (D6), Mushroom ash (D7).



Mute Floor x4



Mute Floor x2



Mute Floor x1

Illustration	Description	Article number	Fabric group	White laquer	Optional NCS	Veneer group 1	Veneer group 2
			PG 1	14 534	15 401	16 269	16 269
PG 2	14 908	15 775	16 643	16 643			
PG 3	15 282	16 149	17 017	17 017			
PG 4	15 656	16 523	17 391	17 391			
PG 5	16 030	16 897	17 765	17 765			
PG 6	16 672	17 540	18 407	18 407			
PG 7	17 635	18 503	19 371	19 371			
Leather	18 834	19 702	20 569	20 569			
	2 371	2 371	2 831	2 831			
	124	124	124	124			
	Mute Floor x4, 200x180x136cm.	55 xx 06790-xxx	PG 1	14 534	15 401	16 269	16 269
	Inkl.2 xpower 2x double		PG 2	14 908	15 775	16 643	16 643
	USB-C charger (PD50+52)		PG 3	15 282	16 149	17 017	17 017
	LED lamp ,mat anthracite.		PG 4	15 656	16 523	17 391	17 391
	Delivered knock-down.		PG 5	16 030	16 897	17 765	17 765
	Max.weight for table		PG 6	16 672	17 540	18 407	18 407
	top: 50 kg.		PG 7	17 635	18 503	19 371	19 371
	<i>Upcharge for wooden back</i>		Leather	18 834	19 702	20 569	20 569
	<i>Upcharge for CMHR foam</i>			2 371	2 371	2 831	2 831
	No back wall, entrance from both sides			124	124	124	124
	Mute Floor x2, 200x180x85cm.	55 xx 06985-xxx	PG 1	9 090	10 607	11 518	11 518
	Inkl.2 xpower 1x double		PG 2	9 463	10 981	11 892	11 892
	USB-C charger (PD50+52)		PG 3	9 837	11 355	12 266	12 266
	LED lamp ,mat anthracite.		PG 4	10 024	11 542	12 453	12 453
	Delivered knock-down.		PG 5	10 398	11 916	12 827	12 827
	Max.weight for table		PG 6	10 963	12 482	13 392	13 392
	top: 50 kg.		PG 7	11 811	13 329	14 240	14 240
	<i>Upcharge for CMHR foam</i>		Leather	13 203	14 721	15 632	15 632
	With back wall, entrance from one side			87	87	87	87

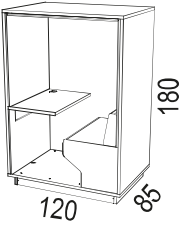
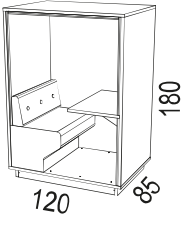
Illustration	Description	Article number	EUR				
			Fabric group	White laquer	Optional NCS	Veneer group 1	Veneer group 2
	<p>Mute Floor left 120x180x85cm. Inkl. 1 xpower 1x double USB-C charger (PD50+52) LED lamp ,mat anthracite. Delivered assembled Max.weight for table top: 50 kg. <i>Upcharge for CMHR foam</i> With back wall, entrance from one side</p>	55 xx 311V-xxx	PG 1	6 619	7 920	8 440	8 440
			PG 2	6 806	8 107	8 627	8 627
			PG 3	7 180	8 481	9 001	9 001
			PG 4	7 367	8 667	9 188	9 188
			PG 5	7 741	9 042	9 562	9 562
			PG 6	8 151	9 453	9 973	9 973
			PG 7	8 768	10 069	10 590	10 590
			Leather	9 236	10 537	11 058	11 058
				62	62	62	62
			<p><i>NOTE: Mute Floor x1 (art 311V/H) is delivered assembled!</i> <i>Please notify customer service if it has to be delivered knock-down due to size limit of entrance doors.</i> <i>The width of the pallet is 95 cm.</i></p>				
	<p>Mute Floor right 120x180x85cm. Inkl. 1 xpower 1x double USB-C charger (PD50+52) LED lamp, mat anthracite Delivered assembled Max.weight for table top: 50 kg. <i>Upcharge for CMHR foam</i> With back wall, entrance from one side</p>	55 xx 311H-xxx	PG 1	6 619	7 920	8 440	8 440
			PG 2	6 806	8 107	8 627	8 627
			PG 3	7 180	8 481	9 001	9 001
			PG 4	7 367	8 667	9 188	9 188
			PG 5	7 741	9 042	9 562	9 562
			PG 6	8 151	9 453	9 973	9 973
			PG 7	8 768	10 069	10 590	10 590
			Leather	9 236	10 537	11 058	11 058
				62	62	62	62
			<p><i>NOTE: Mute Floor x1 (art 311V/H) is delivered assembled!</i> <i>Please notify customer service if it has to be delivered knock-down due to size limit of entrance doors.</i> <i>The width of the pallet is 95 cm.</i></p>				




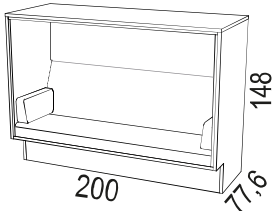
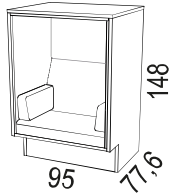
Illustration	Description	Article number	EUR				
Mute Design:Fredrik Mattson							
<p>Mute SOFA AND EASY CHAIR</p>  <ul style="list-style-type: none"> • Frame in lacquered or veneered chipboard. • Padding in HR foam. CMHR against upcharge. • Seat height 46 cm • Delivered assembled. • For more produk information see www.horreds.se <p><u>White lacquer:</u> NCS 0300-N <u>Veneer group 1:</u> Oak (03), Ash (06) <u>Veneer group 2:</u> Black ash (86), Dark ash (76), White oak (30), White ash (10), Burgundy ash (C8), Conifer ash (D3), Smokey Blue ash (D4), Olive ash (D6), Mushroom ash (D7).</p>							
 <p>Mute sofa</p>		 <p>Mute easy chair</p>					
			Fabric group	White laquer	Optional NCS	Veneer group 1	Veneer group 2
	<p>Mute sofa with roof 200x148x77,6cm. Delivered assembled. <i>(Notify customer serv. at the time of ordering if you want it to be sent unassembled!)</i></p> <p><i>Upcharge for CMHR</i></p>	55 xx 04350-xxx	PG 1	6 785	7 512	9 275	9 275
			PG 2	7 065	7 792	9 556	9 556
			PG 3	7 327	8 054	9 818	9 818
			PG 4	7 514	8 241	10 005	10 005
			PG 5	7 832	8 559	10 323	10 323
			PG 6	8 243	8 969	10 733	10 733
			PG 7	8 860	9 586	11 350	11 350
			Leather	13 011	13 737	15 501	15 501
				87	87	87	87
	<p>Mute easy chair with roof 95x148x77,6cm. Delivered assembled.</p> <p><i>Upcharge for CMHR</i></p>	55 xx 03650-xxx	PG 1	4 772	5 499	5 810	5 810
			PG 2	4 959	5 686	5 997	5 997
			PG 3	5 109	5 835	6 146	6 146
			PG 4	5 240	5 966	6 277	6 277
			PG 5	5 426	6 153	6 464	6 464
			PG 6	5 683	6 410	6 721	6 721
			PG 7	6 069	6 795	7 106	7 106
			Leather	7 951	8 677	8 988	8 988
				62	62	62	62


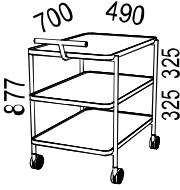
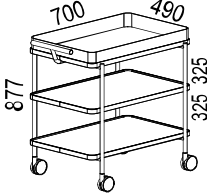
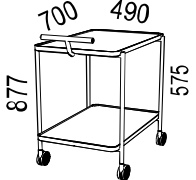
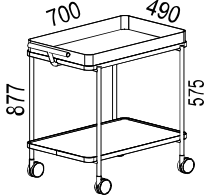



Illustration	Description	Article number	Material	EUR
EXO TROLLEY Design: Mathieu Gustafsson & Daniel Lavonius Jarefeldt, Tengbom				
	<p>EXO-TROLLEY Serving Trolley</p> <ul style="list-style-type: none"> • Trolley in black texture lacquer RAL9005 with castors. Other colours on request. • Shelves in white (31K) and black (37K) compact laminate alternatively oak and ash veneer; oak nature (03), ash nature (06) black ash (86), dark ash (76), white oak (30), white ash (10), Burgundy ash (C8), Conifer ash (D3), Smokey Blue ash (D4), Olive ash (D6), Mushroom ash (D7). • Troughs in black metal and copper, • Serving tray and bottle holder in black metal with inlays matching the shelves. • 4 castors (diameter 75 mm) of which 2 are lockable. • Max weight capacity 50 kilos. • For more product information: see www.horreds.se 			
	<p>Trolley with 3 shelves in compact laminate alt. veneer New: height 877 mm</p>	<p>84 37xx 08383-2</p>	<p>Black</p>	<p>1 327</p>
	<p>Trolley with 1 trough and 2 shelves in compact laminate or veneer. New: height 877 mm <i>Add.cost for extra trough instead of shelf. Price per trough.</i></p>	<p>84 37xx S8383-4 84 37xx K8383-4</p>	<p>Black/trough black Black/trough copper Black Copper</p>	<p>1 421 3 761 94 2 434</p>
	<p>Trolley with 2 shelves in compact laminate alt. veneer New: height 877 mm</p>	<p>84 37xx 08383-1</p>	<p>Black</p>	<p>1 090</p>
	<p>Trolley with 1 trough and 1 shelf in compact laminate or veneer. New: height 877 mm <i>Add.cost for extra trough instead of shelf</i></p>	<p>84 37xx S8383-3 84 37xx K8383-3</p>	<p>Black/trough black Black/trough copper Black Copper</p>	<p>1 184 3 524 94 2 434</p>
	<p>Serving tray in black metal, with inlay in same material as shelves</p>	<p>84 37xx 05424</p>	<p>Black</p>	<p>317</p>
	<p>Bottle holder in black metal, for 3 bottles, with inlay in same material as shelves</p>	<p>84 37xx 05423</p>	<p>Black</p>	<p>330</p>
	<p>Bottle holder in black or white metal, for 6 bottles, with inlay in same material as shelves</p>	<p>84 37xx 05425</p>	<p>Black</p>	<p>342</p>

Illustration	Article number	Pcs	Price / piece Horreds NCS / black gables	Price / piece optional NCS / black gables	Price / piece veneer / black gables
--------------	----------------	-----	--	---	---

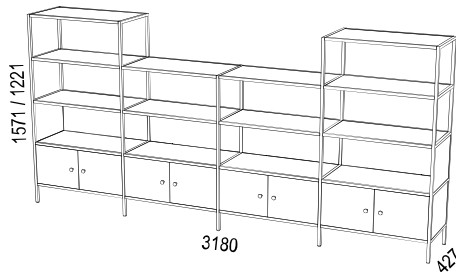
Parant

Parant COMBINATIONS



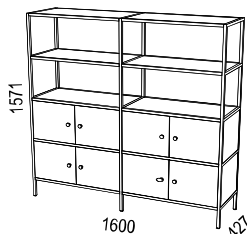
- Parant is a buildable shelf series with black metal gables in several heights. Wooden parts in veneered or lacquered design.
- Gables: RAL9005 structure, with couplings in black plastic.
- Veneer: Oak nature, ash nature, ash white pigmented, ash stained (black, dark, Burgundy, Conifer, Smokey Blue stain, Olive stain and Mushroom stain).
- Horreds NCS colours: see page 172.
- Black knob ø28 mm, height 24 mm.
- Measurement basic unit: B810xH350XD427mm.
- Measurement sideways add-on module: B790xH350XD427mm.
- Add-on plant pot: height 175mm.
- Distance from floor to lowest shelf: 150mm.
- Contact us for a quote if you want a combination that is not illustrated below.
- For more information; see www.horreds.se

Combination A.



Gable 1571x427	34	37	040-A	2	254	254	254
Middle gable 1571x427	34	37	140-B	2	261	261	261
Middle gable 1221x427	34	37	130-A	1	223	223	223
Shelf	34	37xx	09207	14	122	139	157
Back cover	34	37xx	09212	4	96	113	121
Side cover	34	37xx	09331	2	63	77	81
Door module, start	34	37xx	37002	1	553	699	875
Door module, middle	34	37xx	37003	2	553	699	875
Door module, , finish	34	37xx	37004	1	553	699	875
Total price combination A:					5 684	6 603	7 598

Combination B.



Gable 1571x427	34	37	040-A	2	254	254	254
Middle gable 1571x427	34	37	140-A	1	261	261	261
Shelf	34	37xx	09207	6	122	139	157
Door module, start	34	37xx	37002	2	553	699	875
Door module, finish	34	37xx	37004	2	553	699	875
Total price combination B:					3 713	4 400	5 211

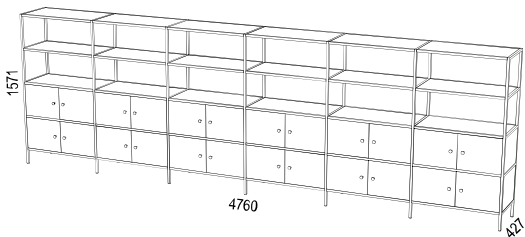
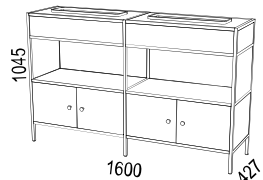
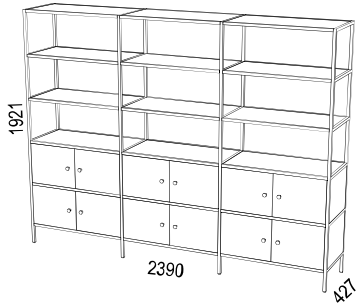
Illustration	Article number	Pcs	Price / piece Horreds NCS / black gables	Price / piece optional NCS / black gables	Price / piece veneer / black gables
Combination C.					
					
Gable 1571x427	34 37 040-A	2	254	254	254
Middle gable 1571x427	34 37 140-A	5	261	261	261
Shelf	34 37xx 09207	18	122	139	157
Door module, start	34 37xx 37002	2	553	699	875
Door module, middle	34 37xx 37003	8	553	699	875
Door module, finish	34 37xx 37004	2	553	699	875
Total price comb. C:			10 644	11 305	15 136
Combination D.					
					
Gable 1046x427	34 37 025-A	2	213	213	213
Middle gable 10461x427	34 37 125-A	1	219	219	219
Shelf	34 37xx 09207	4	122	139	157
Door module, start	34 37xx 37002	1	553	699	875
Door module, finish	34 37xx 37004	1	553	699	875
Pot plant add-on	34 37xx 09222-2	2	331	367	426
Back cover	34 37xx 09212	2	96	113	121
Side cover	34 37xx 09331	2	63	77	81
Total price comb. D:			3 218	3 712	4 279
Combination E.					
					
Gable 1921x427	34 37 050-A	2	290	290	290
Middle Gable 1921x427	34 37 150-A	2	297	297	297
Shelf	34 37xx 09207	12	122	139	157
Door module, start	34 37xx 37002	2	553	699	875
Door module, middle	34 37xx 37003	2	553	699	875
Door module, finish	34 37xx 37004	2	553	699	875
Total price comb. E:			5 956	7 038	8 308

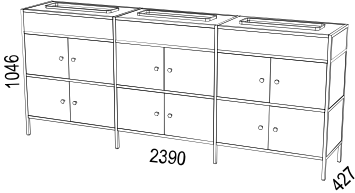
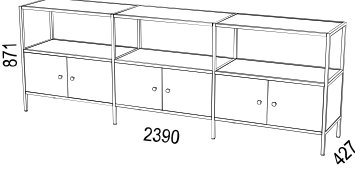
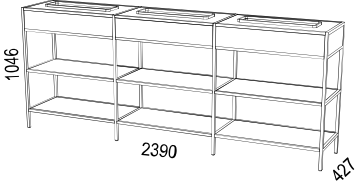
Illustration	Article number	Pcs	Price / piece Horreds NCS / black gables	Price / piece optional NCS / black gables	Price / piece vener / black gables
Combination F.					
					
Gable 1046x427	34 37 025-A	2	213	213	213
Middle gable 1046x427	34 37 125-A	2	219	219	219
Shelf	34 37xx 09207	3	122	139	157
Door module, start	34 37xx 37002	2	553	699	875
Door module, middle	34 37xx 37003	2	553	699	875
Door module, finish	34 37xx 37004	2	553	699	875
Flower pot add-on	34 37xx 09222-2	2	331	367	426
Flower pot add-on, middle	34 37xx 09222-3	1	331	367	426
Total price comb. F:			<u>5 539</u>	<u>6 574</u>	<u>7 862</u>
Combination G.					
					
Gable 871x427	34 37 020-A	2	179	179	179
Gable middle 871x427	34 37 120-A	2	187	187	187
Shelf	34 37xx 09207	6	122	139	157
Door module, start	34 37xx 37002	1	553	699	875
Door module, middle	34 37xx 37003	1	553	699	875
Door module, finish	34 37xx 37004	1	553	699	875
Total price comb. G:			<u>3 123</u>	<u>3 664</u>	<u>4 299</u>
Combination H.					
					
Gable 1046x427	34 37 025-A	2	213	213	213
Gable middle 1046x427	34 37 125-A	2	219	219	219
Shelf	34 37xx 09207	9	122	139	157
Flower pot add-on	34 37xx 09222-2	2	331	367	426
Flower pot add-on, middle	34 37xx 09222-3	1	331	367	426
Total price comb. H:			<u>2 953</u>	<u>3 215</u>	<u>3 554</u>

Illustration	Article number	Pcs	Price / piece Horreds NCS / black gables	Price / piece optional NCS / black gables	Price / piece veneer / black gables
Combination I.					
Gable 871x427	34 37 020-A	1	179	179	179
Gable middle 1221x427	34 37 130-B	1	223	223	223
Gable middle 1571x427	34 37 140-B	1	261	261	261
Gable 1571x427	34 37 040-A	1	254	254	254
Shelf	34 37xx 09207	6	122	139	157
Door module, start	34 37xx 37002	2	553	699	875
Door module, middle	34 37xx 37003	2	553	699	875
Door module, finish	34 37xx 37004	2	553	699	875
Total price combination I:			<u>4 967</u>	<u>5 946</u>	<u>7 109</u>


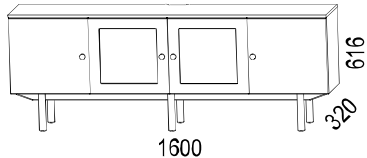
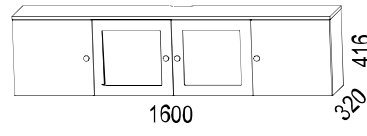
Illustration	Description	Article number	Material	EUR															
<div style="display: flex; justify-content: space-between;"> <div style="width: 30%;">  </div> <div style="width: 65%;"> <p>CONNECT Media bench</p> <ul style="list-style-type: none"> • Lacquered media bench, choose from 3 different colours. • Black knobs are standard. Coloured lacquered knobs available at extra cost. • Doors with soft-close hinges • Delivered assembled. • Screws for wall mounting brackets not included. • For more product information see www.horreds.se <p style="text-align: center;">Colours:</p> <table style="width: 100%; border: none;"> <tr> <td style="width: 33%;">BE Beige S3005-Y20R</td> <td style="width: 33%;">GG Greige 2903-Y30R</td> <td style="width: 33%;">BY Burgundy S 7010-R10B</td> </tr> <tr> <td>CH Chalk S 0300-N</td> <td>LG Lightgrey S 3000-N</td> <td>GP Graphite S 7500-N</td> </tr> <tr> <td>GW Greywhite S 1500-N</td> <td>SB Soft Beige S 2010-Y30R</td> <td>LI Linen S 2005-Y20R</td> </tr> <tr> <td>OL Olive S 5010-G30Y</td> <td>SD Sand S 4005-Y50R</td> <td>SG Steel Grey S 4500-N</td> </tr> <tr> <td>WW Warm White 1204-Y26R</td> <td></td> <td></td> </tr> </table> </div> </div>					BE Beige S3005-Y20R	GG Greige 2903-Y30R	BY Burgundy S 7010-R10B	CH Chalk S 0300-N	LG Lightgrey S 3000-N	GP Graphite S 7500-N	GW Greywhite S 1500-N	SB Soft Beige S 2010-Y30R	LI Linen S 2005-Y20R	OL Olive S 5010-G30Y	SD Sand S 4005-Y50R	SG Steel Grey S 4500-N	WW Warm White 1204-Y26R		
BE Beige S3005-Y20R	GG Greige 2903-Y30R	BY Burgundy S 7010-R10B																	
CH Chalk S 0300-N	LG Lightgrey S 3000-N	GP Graphite S 7500-N																	
GW Greywhite S 1500-N	SB Soft Beige S 2010-Y30R	LI Linen S 2005-Y20R																	
OL Olive S 5010-G30Y	SD Sand S 4005-Y50R	SG Steel Grey S 4500-N																	
WW Warm White 1204-Y26R																			
	<p>Media bench 1600x516x320 mm including leg base in clear lacquered oak. With 2 wooden doors and 2 glass doors with frosted glass. Includes black knobs and removable shelves.</p> <p><i>Additional cost for knobs (4 pcs) in colour lacquer matching the frame instead of black</i></p>	<p>34 xx xx xx 16003</p>	<p>Lacquered</p>	<p>1 624</p> <p style="text-align: right;">52</p>															
	<p>Media bench 1600x416x320 mm including wall mounting brackets.</p> <p>With 2 wooden doors and 2 glass doors with frosted glass. Includes black knobs and removable shelves.</p> <p><i>Additional cost for knobs (4 pcs) in colour lacquer matching the frame instead of black</i></p>	<p>34 xx xx xx 16000</p>	<p>Lacquered</p>	<p>1 259</p> <p style="text-align: right;">52</p>															



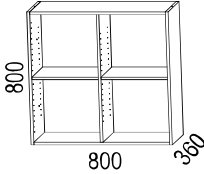
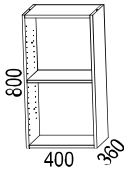
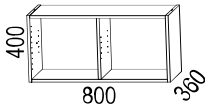
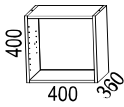
Illustration	Description	Article number	Material	EUR															
<div style="display: flex; justify-content: space-between; align-items: flex-start;"> <div style="width: 25%;">  </div> <div style="width: 50%;"> <p>ANNE Design: Anne Krook.</p> <ul style="list-style-type: none"> • White lacquer = NCS S0300-N (Chalk) • Veneer: Oak (03), only on smooth fronts and top shelves. • Knobs in stainless steel and selected colours, ordered separatley.. • Drawers and doors are factory-assembled. • Always include a sketch. Feel free to use the drawing programme in Pcon Planner. • Doors with soft-close hinges • Drawers with self-closing, soft-close expanders. • Configurator to quickly see the price for your desired setup; see www.horreds.se/Produkter/Förvaring/Anne • For more product information, see www.horreds.se <p style="text-align: center;">Colours:</p> <table style="width: 100%; border: none;"> <tr> <td style="width: 33%;">BE Beige S3005-Y20R</td> <td style="width: 33%;">GG Greige 2903-Y30R</td> <td style="width: 33%;">BY Burgundy S 7010-R10B</td> </tr> <tr> <td>CH Chalk S 0300-N</td> <td>LG Lightgrey S 3000-N</td> <td>GP Graphite S 7500-N</td> </tr> <tr> <td>GW Greywhite S 1500-N</td> <td>SB Soft Beige S 2010-Y30R</td> <td>LI Linen S 2005-Y20R</td> </tr> <tr> <td>OL Olive S 5010-G30Y</td> <td>SD Sand S 4005-Y50R</td> <td>SG Steel Grey S 4500-N</td> </tr> <tr> <td>WW Warm White 1204-Y26R</td> <td></td> <td></td> </tr> </table> </div> <div style="width: 20%; text-align: right;">  </div> </div>					BE Beige S3005-Y20R	GG Greige 2903-Y30R	BY Burgundy S 7010-R10B	CH Chalk S 0300-N	LG Lightgrey S 3000-N	GP Graphite S 7500-N	GW Greywhite S 1500-N	SB Soft Beige S 2010-Y30R	LI Linen S 2005-Y20R	OL Olive S 5010-G30Y	SD Sand S 4005-Y50R	SG Steel Grey S 4500-N	WW Warm White 1204-Y26R		
BE Beige S3005-Y20R	GG Greige 2903-Y30R	BY Burgundy S 7010-R10B																	
CH Chalk S 0300-N	LG Lightgrey S 3000-N	GP Graphite S 7500-N																	
GW Greywhite S 1500-N	SB Soft Beige S 2010-Y30R	LI Linen S 2005-Y20R																	
OL Olive S 5010-G30Y	SD Sand S 4005-Y50R	SG Steel Grey S 4500-N																	
WW Warm White 1204-Y26R																			
Anne BASIC UNITS																			
	Basic unit with fixed partition and removable shelf	16 xx 009D	Lacquered	545															
	Basic unit with fixed partition and removable shelf	16 xx 011D	Lacquered	376															
	Basic unit with fixed partition Basic unit without fixed partition (for drawer art 040)	16 xx 012D 16 xx 012DU	Lacquered Lacquered	376 338															
	Basic unit	16 xx 013D	Lacquered	261															

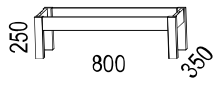
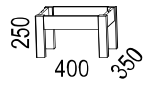
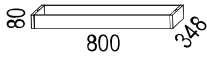
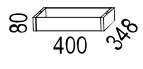
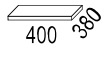
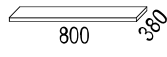
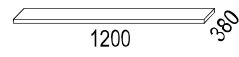
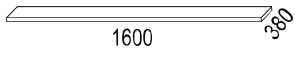
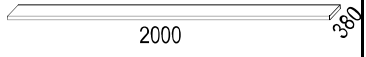
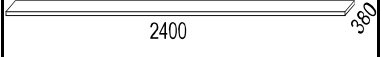
Illustration	Description	Article number	Material	EUR
Anne BASES				
	Leg base, wood	16 xx 017D	Lacquered	260
	Leg base, wood	16 xx 018D	Lacquered	228
	Base, wood	16 xx 007D	Lacquered	110
	Base, wood	16 xx 008D	Lacquered	102
	kg			
	800 mm	16 00 045		47
	400 mm	16 00 046		44
Anne TOP SHELVES. • Depth 380 mm. Thickness 23 mm.				
	Width 400 mm	16 03 201 16 xx 201	Oak Lacquered	181 163
	Width 800 mm	16 03 202 16 xx 202	Oak Lacquered	210 193
	Width 1200 mm	16 03 203 16 xx 203	Oak Lacquered	245 208
	Width 1600 mm	16 03 204 16 xx 204	Oak Lacquered	308 236
	Width 2000 mm	16 03 206 16 xx 206	Oak Lacquered	356 244
	Width 2400 mm	16 03 207 16 xx 207	Oak Lacquered	401 270

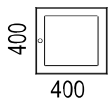
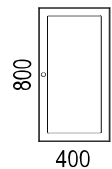
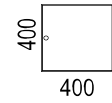
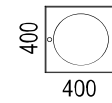
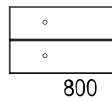
Illustration	Description	Article number	Material	EUR
Anne DOORS & DRAWERS				
<p>Knobs are ordered separately, stainless steel, black or selected colours.</p> <p>The doors have soft-close hinges. Drawers have soft-close mechanism.</p> <p>Available in the following colours (NCS):</p> <p>BE Beige S3005-Y20R GG Greige 2903-Y30R BY Burgundy S 7010-R10B CH Chalk S 0300-N LG Lightgrey S 3000-N GP Graphite S 7500-N GW Greywhite S 1500-N SB Soft Beige S 2010-Y30R LI Linen S 2005-Y20R OL Olive S 5010-G30Y SD Sand S 4005-Y50R SG Steel Grey S 4500-N WW Warm White 1204-Y26R</p>				
	Display door Anne - clear glass	16 xx 035	Lacquered	154
	Display door Anne - fluted glass	16 xx 035R	Lacquered	172
	Display door Anne - clear glass	16 xx 036	Lacquered	225
	Display door Anne - fluted glass	16 xx 036R	Lacquered	249
	Wooden door Anne	16 03 021 16 xx 021	Oak Lacquered	148 101
	Wooden door Anne	16 03 022 16 xx 022	Oak Lacquered	207 136
	Display door Anne - round clear glass	16 03 034 16 xx 034	Oak Lacquered	184 136
	Drawer pair Anne. Fits only 12DU <i>Requires 4 knobs.</i>	16 03 040 16 xx 040	Oak Lacquered	533 462
	Drawer pair Anne <i>Requires 2 knobs.</i>	16 03 041 16 xx 041	Oak Lacquered	474 403
	Knob, diameter 25mm	16 17 001 16 BK 001 16 xx 001	SS look Black Selected col.	10 10 23

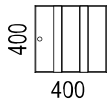
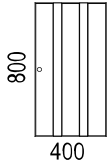
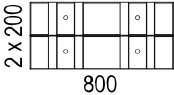
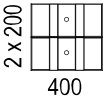
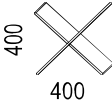

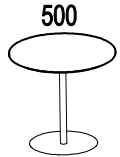
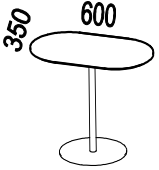
Illustration	Description	Article number	Material	EUR
Anne GROOVED DOORS & DRAWERS				
Knobs are ordered separately, stainless steel, black or selected colours.				
The doors have soft-close hinges. Drawers have soft-close mechanism.				
Available in the following colours (NCS):				
BE Beige S3005-Y20R	GG Greige 2903-Y30R	BY Burgundy S 7010-R10B		
CH Chalk S 0300-N	LG Lightgrey S 3000-N	GP Graphite S 7500-N		
GW Greywhite S 1500-N	SB Soft Beige S 2010-Y30R	LI Linen S 2005-Y20R		
OL Olive S 5010-G30Y	SD Sand S 4005-Y50R	SG Steel Grey S 4500-N		
WW Warm White 1204-Y26R				
	Wooden door Anne, grooved	16 xx 621	Lacquered	124
	Wooden door Anne, grooved	16 xx 622	Lacquered	160
	Drawer pair Anne, grooved. Fits only 12DU <i>Requires 4 knobs.</i>	16 xx 640	Lacquered	498
	Drawer pair Anne, grooved <i>Requires 2 knobs.</i>	16 xx 641	Lacquered	438
	Knob, diameter 25mm	16 17 001 16 BK 001 16 xx 001	SS look Black Selected col.	10 10 23
Anne ACCESSORIES				
	Wine rack fits 9D Wine rack fits 11D + 12D Wine rack fits 13D	16 xx 042A 16 xx 042B 16 xx 042C	Lacquered Lacquered Lacquered	189 189 189
	Extra shelf, for 9D+12D. width 37,5 cm.	16 xx 044	Lacquered	59
	Extra shelf, for 11D+13D, width 36,7 cm.	16 xx 044B	Lacquered	59

Illustration	Description	Article number	Material	EUR
	<p>LAP Design: Fredrik Mattson</p> <ul style="list-style-type: none"> • Table top in 19 mm veneerd MDF 19 with chamfered edge. • Column legin 3 heights. Illustrations below show table in height 430 mm <p><u>Veneer group 1:</u> Oak (03), Ash (06), Birch (05), Beech (04)</p> <p><u>Veneer group 2:</u> Black stained Ash (86), Dark stained Ash (76), White pigmented Oak (30), White pigmented Ash (10) Burgundy ash (C8), Conifer ash (D3), Smokey Blue ash (D4), Oliver ash (D6), Mushroom ash (D7).</p> <p><u>Column legs RAL:</u> 3007 Black red (3D), 5008 Grey blue (3C), 6013 Reed green (3K), 7044 Silk grey (3A), 9005 Jet black (37), 9016 Traffic white (31).</p> <p><u>Heights:</u> 430 mm (1), 530 mm (-2), 630 mm (-3)</p> <ul style="list-style-type: none"> • For more information, see www.horreds.se 			
	<p>Round table top, diameter 500 mm, including column leg with round base Height: 430, 530 or 630 mm.</p>	<p>55 xx xx 03802-x 55 xx xx 03802-x</p>	<p>Veneer gr 1 Veneer gr 2</p>	<p>390 390</p>
	<p>Oval table top, 600x350 mm, including column leg with round base Height: 430, 530 or 630 mm.</p>	<p>55 xx xx 03803-x 55 xx xx 03803-x</p>	<p>Veneer gr 1 Veneer gr 2</p>	<p>414 414</p>

SALES TERMS

All previous price lists are no longer valid. All prices are quoted in Euro excl. VAT. Our digital price list is regularly updated and products may be added or discontinued. Price adjustments may occur. For the latest issue, see www.horreds.se

TERMS OF PAYMENT

30 days net or according to agreement.

When payment falls due, we reserve the right charge 2% interest/month. Payment by cheque is not accepted. Only International bank transfers are accepted. Bank details according to the invoice.

TERMS OF DELIVERY

Deliveries will only be effected at our terms of payment and delivery. The goods remain the property of Horreds Möbel AB until full payment has been settled. Dispatch date is when goods are leaving factory. Standard package is included, pallets and wooden crates are charged separately. Tail gates, fixed delivery date and telephone notification will be charged separately. Quotations submitted by Horreds are, unless otherwise stated, valid for 30 days from the quotation date. For deliveries well ahead of time, e.g. 6 months from the quotation date, this must be agreed on each individual occasion.

FREIGHT CHARGES

Europe 1

Finland, Latvia, Lithuania, Estonia, Germany, Benelux.

Free delivery DAP on order above 2500 Euro net. For orders less than 2500 Euro, a freight cost of 225 Euro is charged.

Europe 2

Austria, United Kingdom, Poland, Czech Republic, Slovakia, Hungary.

Free delivery DAP on order above 2500 Euro net. For orders less than 2500 Euro, a freight cost of 350 Euro is charged.

Other countries

Ex Works or according to agreement. (documents sent by courier will be charged)

CLAIMS AND TRANSPORT DAMAGES

Any claims or transport damages must be reported to Horreds. A special claim report shall be sent in together with photos to export@horreds.se. Visible damages must also be notified on the waybill when receiving the goods. Invisible damages must be reported within 6 days. Photos must be taken on all damages for us to be able to handle the claim.

GUARANTEE

Office furniture according to Price list 1: 10 years for wood and metal parts with the exception of electric legs having 5 or 10 year-warranty (read more under the respective product). Clothing material for table screens and insert materials which have 1 year.

Meeting places/Environmental furniture according to Price list 2: 5 years with the exception of clothing material and input material which have 1 year.

Input material such as locks, hinges, electrical parts, expanders and lamps: 1 year.

Customized products: 1 year.

The guarantees are valid from the date of the original invoice against productions errors at normal use of the product. We reserve the right to make changes in construction and design without notice.

FORCE MAJEURE

Horreds shall not be liable for any loss, damage, delay, changes in shipment schedules or failure to deliver caused by accidents, fire, strikes, riots, civil commotion, insurrection, war, the elements, embargoes, failure of carriers, inability to obtain transportation facilities, government requirements, acts of God or public enemy, prior orders from customers or limitations on the company's or its supplier's production or marketing activities or any other causes or contingencies beyond the company's control.


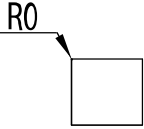
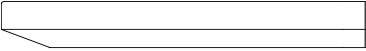
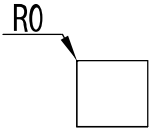

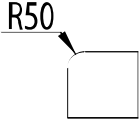

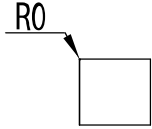
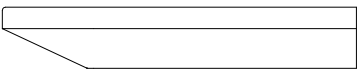
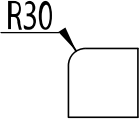

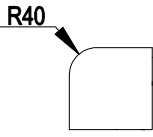
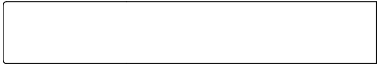
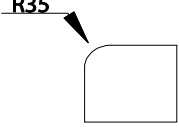

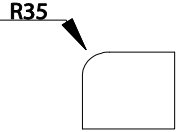
SHOWROOMS: Horreds Möbel AB (Head Office), Varbergsvägen 448, HORRED. Tel +46 320 184 00
R40, Rosenlundsgatan 40, STOCKHOLM. Tel +46 73 828 00 15
Studio L6, Lasarettsgatan 6, GÖTEBORG. Tel +46 70 241 99 69
Horreds Möbel AB, Slussgatan 10, 211 30 MALMÖ. Tel +46 70 241 99 69

pCon PLANNER

Download pCon planner and use our 3D dwg files which are available in pCon Cataloge

For additional information and for download free of charge:
see www.horreds.se

www.pcon-planner.com

	<u>Profil / profile:</u>	<u>Radie / radius :</u>
<p><u>VX (3416)</u> Rak matchande kantlist i plast alternativt faner. Hörradie 0. <i>Straight edge, matching edging. Corner radius 0.</i></p>		<p>R0</p> 
<p><u>VX (3417)</u> Fasad kant med rak matchande kantlist i plast alternativt faner. Hörradie 0. <i>Chamfered edge with straight matching edging.</i> Corner radius 0.</p>		<p>R0</p> 
<p><u>VX R50 (3418)</u> Rak matchande kantlist i plast alternativt faner. Hörradie 50. <i>Straight edge, matching edging. Corner radius 50.</i></p>		<p>R50</p> 
<p><u>A-Frame (6416) / Nomono (53) / Tin (47)</u> Rak, matchande kantlist i plast alternativt faner. Hörradie 0. <i>Straight edge, matching edging. Corner radius 0.</i></p>		<p>R0</p> 
<p><u>Fri (3517)</u> Fasad MDF-kant. Klarlackad kant till ask, björk, ek, laminat och desktop. Matchande till betsade och vitpigmenterade bord. Hörradie 30. <i>Chamfered MDF edge. Clear coated edge on ash, birch, oak, laminate and linoleum. Matching colour to stained and white pigmented tables.</i> Corner radius 30.</p>		<p>R30</p> 
<p><u>Henry (80)</u> Rak, vit plastkantlist. Hörradie 40. <i>Straight edge, white edging. Corner radius 40.</i></p>		<p>R40</p> 
<p><u>Siglo (6016)</u> Matchande kantlist i plast till laminat och desktop. Vit kantlist i plast till fanerade bord. Hörradie 35. <i>Matching edging to laminate and linoleum. White edging to veneered desks. Corner radius 35.</i></p>		<p>R35</p> 
<p><u>Siglo (6020)</u> Falsad kant med matchande kantlist i plast till laminat och desktop. Vit kantlist i plast till fanerade bord. Hörradie 35. <i>Chamfered with matching edging to laminate and linoleum.</i> <i>White edging to veneered desks. Corner radius 35.</i></p>		<p>R35</p> 

FANER / VENEER



06 Ask / Ash



03 Ek / Oak



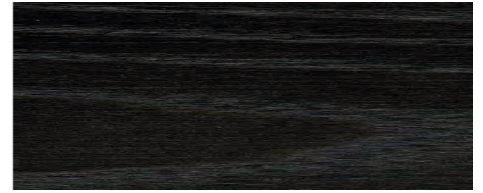
05 Björk / Birch



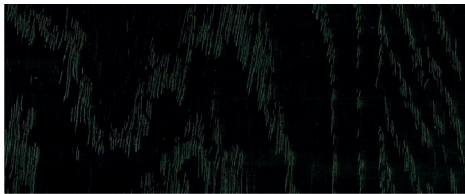
10 Vit ask / White ash



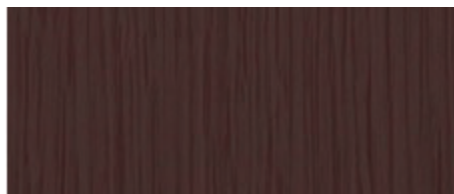
30 Vit ek / White oak



76 Mörk ask / Dark ash



86 Svart ask / Black ash



C8 Burgundy ask / ash



D3 Conifer ask / ash



D4 Smokey Blue ask / ash



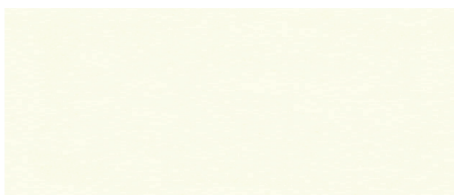
D6 Olive ask / ash



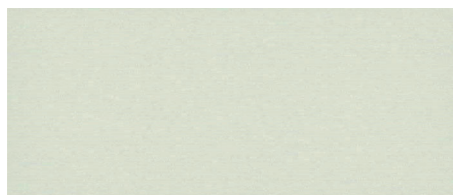
D7 Mushroom ask / ash

Tänk på: I trä som är en naturprodukt kan mindre avvikelser i bets och struktur förekomma / Note: In wood, that is a natural product, minor deviations in stain and structure can occur

LAMINAT (endast bordsskivor) / LAMINATE (table tops only)



Vit 0754 (standardlaminat)
närmaste NCS S0502-Y



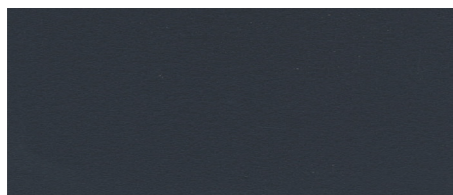
Ljusgrå 0419 (tillvalslaminat)
närmaste NCS S1500-N



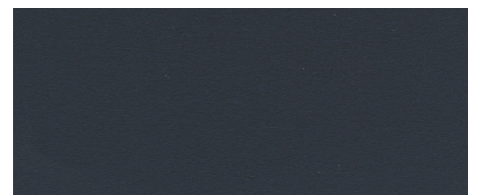
Ljusgrå 1365 (tillvalslaminat)
närmaste NCS S2005-R80B



Mellanrå 1023 (tillvalslaminat)
närmaste NCS S5500-N



Antracit 1397 (tillvalslaminat)
närmaste NCS S7500-N



Svart 2253 (tillvalslaminat)
närmaste NCS S9000-N

DESKTOP (endast bordsskivor) / LINOLEUM (table tops only)



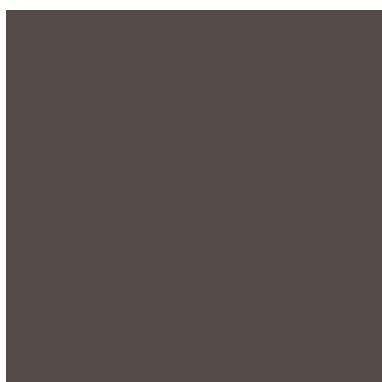
4132 Ash (1B)
closest NCS 5502-G



4154 Burgundy (1C)
closest NCS 7010-R10B



4166 Charcoal (1G)
closest NCS 8502-B



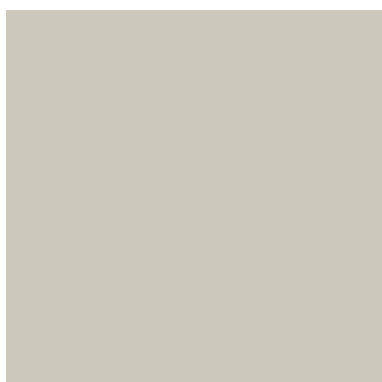
4172 Mauve (1U)
closest NCS 7005-Y80R



4174 Conifer (1H)
closest NCS 8010-B90G



4175 Pebble (1I)
closest NCS 3502-Y



4176 Mushroom (1J)
closest NCS 2002-Y



4177 Vapour (1K)
closest NCS 2005-G10Y



4179 Smokey Blue (1M)
closest NCS 7010-R90B



4184 Olive (1R)
closest NCS 5010-G50Y

Färgavvikelser kan förekomma av trycktekniska skäl

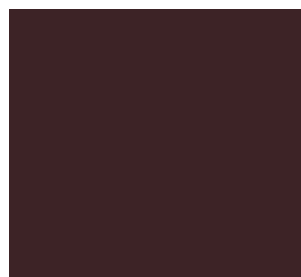
RAL-KULÖRER METALL / RAL COLOURS METAL



1019 Grey beige (3H)
Tillval utvalda produkter
Optional selected products



1024 Ochre yellow (3G)
Tillval utvalda produkter
Optional selected products



3007 Black red (3D)
Tillval utvalda produkter
Optional selected products



5008 Grey blue (3C)
Tillval utvalda produkter
Optional selected products



6009 Fir green (3L)
Tillval utvalda produkter
Optional selected products



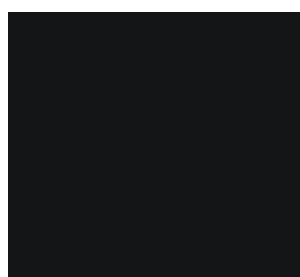
6013 Reed green (3K)
Tillval utvalda produkter
Optional selected products



7039 Quartz grey (3J)
Tillval utvalda produkter
Optional selected products



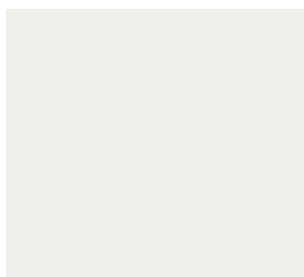
7044 Silk grey (3A)
Tillval utvalda produkter
Optional selected products



9005 Jet black (37)
Standard



9006 White alu. (38)
Standard utvalda produkter
Standard selected products



9016 Traffic white (31)
Standard/tillval utvalda produkter
Standard/optional selected prod.

Slät lack med glans 30. Vissa produkter finns endast i standardkulör med strukturlack.

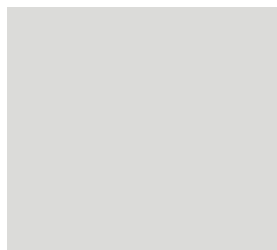
Smooth varnish, gloss 30. Some products are only available in standard colour with textured paint.

Färgavvikelser kan förekomma av trycktekniska skäl
Colour deviations may occur for printing technical reasons.

TILLVALSKULÖRER NCS / SELECTED COLOURS NCS



WW Warm white
1204-Y26R



GW Greywhite
S 1500-N



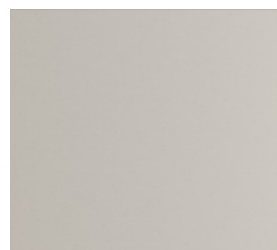
LG Lightgrey
S 3000-N



SG Steel grey
S 4500-N



GP Graphite
S 7500-N



GG Greige
2903-Y30R



BE Beige
S3005-Y20R



SB Soft beige
S 2010-Y30R



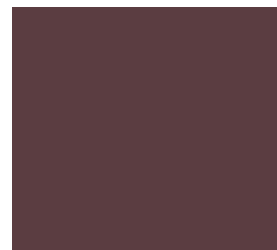
LI Linen
S 2005-Y20R



SD Sand
S 4005-Y50R



OL Olive
S 5010-G70Y



BY Burgundy
S 7010-R10B

Färgavvikelse kan förekomma av trycktekniska skäl

Colour deviations may occur for printing technical reasons.

Price groups fabrics

Below you find a list of standard fabrics for our seating furniture.

The list shows the difference price groups and which products it is suitable for.

For price information for fabrics not listed below; please send us a price inquiry.

Several of our products can be produced with multiple fabrics; please send us a price inquiry.

Producer:	Fabric:	Price group:	Base / Cuba	Glove	VX barpall	Mute / LOG / Nomono Bench	Grand / Prime
Camira	Main Line Flax	PG1	•	•	•	•	•
Gabriel	Cura	PG1	•	•	•	•	•
Gabriel	Focus	PG1	•	•	•	•	•
Gabriel	Focus Melange	PG1	•	•	•	•	•
Gabriel	Go Uni	PG1	•	•	•	•	•
Gabriel	Medley	PG1	•	•	•	•	•
Gabriel	Step	PG1	•	•	•	•	•
Kvadrat	Autumn	PG1	•	•	•	•	•
Kvadrat	Guest	PG1	•	•	•	•	•
Vescom	Colour Connect	PG1	•	•	•	•	•
Camira	Blazer	PG2	•	•	•	•	•
Camira	Monochrome sett	PG2	•	•	•	•	•
Gabriel	Go Check	PG2	•	•	•	•	•
Gabriel	Parcel Loop	PG2	•	•	•	•	•
Gabriel	Step Melange	PG2	•	•	•	•	•
Gabriel	Tempt	PG2	•	•	•	•	•
Kvadrat	Reflect	PG2	•	•	•	•	•
Kvadrat	Relate	PG2	•	•	•	•	•
Kvadrat	Remix	PG2	•	•	•	•	•
Nevotex	Grace	PG2	•	•	•	•	•
Nevotex	Lido	PG2	•	•	•	•	•
Nevotex	Lido Trend	PG2	•	•	•	•	•
Nevotex	Pod	PG2			•	•	•
Nevotex	Stella	PG2	•	•	•	•	•
Svensson	Ally	PG2	•	•	•	•	•
Svensson	Easy	PG2	•	•	•	•	•
Vescom	Avon	PG2	•	•	•	•	•
Vescom	Arches	PG2	•	•		•	•
Vescom	Arrow	PG2	•	•		•	•
Vescom	Creek	PG2	•	•		•	•
Vescom	Cyprus	PG2	•	•		•	•
Vescom	Dalma	PG2	•	•		•	•
Vescom	Furka Plus	PG2	•	•		•	•
Vescom	Jemo	PG2	•	•		•	•
Vescom	Leone Plus	PG2	•	•		•	•
Vescom	Malta	PG2	•	•		•	•
Vescom	Samar	PG2	•	•	•	•	•
Vescom	Scott	PG2	•	•		•	•

Vescom	Zenith	PG2	•	•	•	•	•
Camira	ReSKU 2.0	PG3	•	•	•	•	•
Camira	Synergy	PG3	•	•	•	•	•
Gabriel	Amaze Loop	PG3	•	•	•	•	•
Gabriel	Breeze Fusion	PG3	•	•	•	•	•
Gabriel	Capture	PG3	•	•	•	•	•
Gabriel	Crisp	PG3	•	•	•	•	•
Gabriel	Fame	PG3	•	•	•	•	•
Gabriel	Morph	PG3	•	•	•	•	•
Gabriel	Renewed Loop	PG3	•	•	•	•	•
Gabriel	Select	PG3	•	•	•	•	•
Kvadrat	Ame	PG3	•	•	•	•	•
Kvadrat	Atlas	PG3	•	•	•	•	•
Kvadrat	Sport	PG3	•	•	•	•	•
Kvadrat	Technicolour	PG3	•	•	•	•	•
Nevotex	Sealife	PG3	•	•	•	•	•
Nevotex	Wooly	PG3	•	•	•	•	•
Svensson	Semi	PG3	•	•	•	•	•
Vescom	Acton	PG3	•	•	•	•	•
Vescom	Bowen	PG3	•	•	•	•	•
Vescom	Moore	PG3	•	•	•	•	•
Vescom	Norfolk	PG3	•	•	•	•	•
Vescom	Wilson	PG3	•	•	•	•	•
Gabriel	Grain	PG4	•	•	•	•	•
Gabriel	Passion	PG4	•	•	•	•	•
Jørgenssen	Puxx 1/2	PG4	•	•	•	•	•
Kvadrat	Canvas	PG4	•	•	•	•	•
Kvadrat	Re-wool	PG4	•	•	•	•	•
Kvadrat	Steelcut	PG4	•	•	•	•	•
Kvadrat	Steelcut Trio	PG4	•	•	•	•	•
Nevotex	Blues	PG4	•	•	•	•	•
Nevotex	Funk	PG4	•	•	•	•	•
Nevotex	Jazz	PG4	•	•	•	•	•
Nevotex	Pop	PG4	•	•	•	•	•
Romo	8028 Elio FR	PG4	•	•	•	•	•
Svensson	BonBon	PG4	•	•	•	•	•
Svensson	Harper	PG4	•	•	•	•	•
Svensson	Mingel	PG4	•	•	•	•	•
Vescom	Auckland	PG4	•	•	•	•	•
Vescom	Coral	PG4	•	•	•	•	•
Vescom	Dikson	PG4	•	•	•	•	•
Vescom	Foster	PG4	•	•	•	•	•
Vescom	Fuga	PG4	•	•	•	•	•
Vescom	Hestan	PG4	•	•	•	•	•
Villa Nova	V3571 Linea	PG4	•	•	•	•	•
Gabriel	Focus Royal	PG5	•	•	•	•	•
Gabriel	Savoy	PG5	•	•	•	•	•
Kirkby Design	K5260 Fleck ECO	PG5	•	•	•	•	•

Kvadrat	Devina / Devina MD	PG5	•	•	•	•	•
Kvadrat	Devina Melange	PG5	•	•	•	•	•
Kvadrat	Fiord	PG5	•	•	•	•	•
Kvadrat	Hallingdal	PG5	•	•	•	•	•
Kvadrat	Hero	PG5	•	•	•	•	•
Kvadrat	Steelcut Quartet	PG5	•	•	•	•	•
Maharam	Merit	PG5	•	•	•	•	•
Maharam	Messenger	PG5	•	•	•	•	•
Nevotex	Grand Lazio Velvet	PG5	•	•	•	•	•
Nevotex	Illusion	PG5	•	•		•	•
Nevotex	Illusion Full grain	PG5	•	•		•	•
Svensson	Rami	PG5	•	•	•	•	•
Vescom	Lamu	PG5	•	•	•	•	•
Vescom	Lani	PG5	•	•	•	•	•
Vescom	Wolin	PG5	•	•	•	•	•
Kirkby Design	K5186 Fibre	PG6	•	•	•	•	•
Kvadrat	Keiga	PG6	•	•	•	•	•
Kvadrat	Mizmaze	PG6	•	•	•	•	•
Nevotex	Barnum	PG6	•	•	•	•	•
Gabriel	Nobel	PG7	•	•	•	•	•
Gabriel	Umi	PG7	•	•	•	•	•
Kvadrat	Arda	PG7	•	•	•	•	•
Kvadrat	Sisu	PG7	•	•	•	•	•
Elmo Leather	Elmonordic	PGL	•	•	•	•	•
Elmo Leather	Elmosoft	PGL	•	•	•	•	•
Nevotex	Vintage	PGL	•	•	•	•	•

REV. 260113

BE THE
REBEL
WITH A
PURPOSE.



Horreds Möbel AB
Varbergsvägen 448, SE-519 30 Horred, SWEDEN
ph. +46 320 184 00, info@horreds.se

www.horreds.se